



## Diamond and CBN tools



### Diamond and CBN tools

■ Highlights from the PFERD range	3
■ The quick way to find the perfect tool	4
■ Materials	5
■ Customer-specific tool solutions	5
■ Safety notes and recommended cutting speeds	6
■ Recommended rotational speed range	7



### Diamond and CBN tools – resinoid bond

■ Diamond grinding tools	40
■ CBN grinding tools	42
■ Sharpening block for diamond and CBN tools	43



### Diamond and CBN tools – electroplated bond

■ Diamond escapement files	8
■ Diamond needle files	10
■ Diamond riffler files	14
■ Diamond handy files	15
■ Conical diamond files	17
■ Diamond machinist's files	17
■ Flexible diamond files	19
■ Diamond sheets	19
■ Diamond files for manual filing tools	20
■ Diamond grinding points	21
■ Diamond grinding discs	26
■ CBN grinding points	27
■ CBN grinding discs	30
■ Diamond cut-off wheels	31
■ Diamond cut-off wheels and grinding points for foundries	32
■ Diamond grinding discs CC-GRIND SOLID DIAMOND	34
■ Diamond sabre saw blades	34



### Diamond cut-off wheels for the construction industry

■ Segmented type for fast cutting	44
■ Type with continuous rim for easy cutting (TURBO)	45
■ Type with continuous rim for very fine cutting	46
■ Sharpening block	47



### Flexible diamond files and diamond sheets

The flexible diamond files perfectly adapt to the workpiece surface. Due to their flexibility, they can be used in convex and concave contours with small radii.

The diamond sheets are exceptionally well-suited to work on larger surfaces. Convex and concave contours can be worked on with relatively little effort.

Scan the QR code to find out more about flexible diamond files and diamond sheets.

**Advantages:**

- Ideal for work on hardened steel.
- No chemical wear thanks to the low working temperatures.
- Longer tool life due to harder diamond grain. Compared against tools with conventional abrasives such as aluminium oxide and silicon carbide.

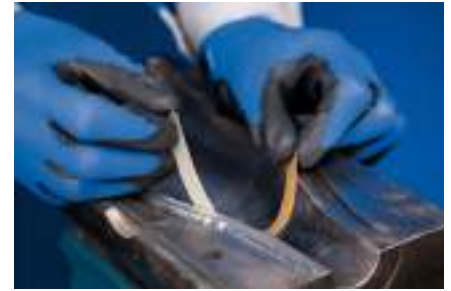

### Customer-specific products made to order

PFERD specializes in consulting for and the production of customer-specific electroplated diamond and CBN tools.

Almost all tool blank geometries can be coated with various grit sizes. The electroplated bond also enables economic production of small batch sizes. Because of the diverse possibilities, our production can respond to individual customer requirements with a high degree of flexibility.

Our technical advisers will be happy to visit you on-site to develop individual and economical tool solutions for your applications.

Get the best possible advice for super-hard solutions! Scan the QR code to find out more about customer-specific products made to order.



### Customer-specific tool solutions for grey and nodular cast iron



#### Tools for auxiliary spindles

PFERD offers tools for auxiliary spindles in different shapes/geometries and dimensions as well as with M12 and M16 threads.

#### Cut-off wheels and grinding discs

Diamond cut-off wheels and diamond grinding discs from PFERD can be purchased in diameters of up to 600 mm. Shapes and dimensions (hole, radius, reference circle, etc.) can be produced according to customer requirements.

#### Grinding points and grinding drums



















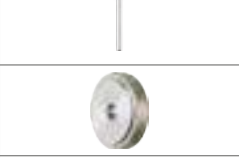

The range of PFERD tools that can be produced according to customer requirements includes diamond grinding drums and diamond grinding points. These can be customized with different shapes, dimensions and shanks.

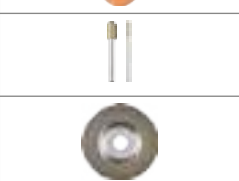

# Diamond and CBN tools

The quick way to find the perfect tool



Use	Material	Application	Tools
<b>Filing</b> 	Hardened steels, tungsten carbide, ceramics, glass, ferrite, nickel-based and titanium-based alloys	Precision filing	Diamond files 
		Precision filing with air-powered filing machines	Diamond files for air-powered filing machines 
		Machining concave and convex surfaces	Flexible diamond files Diamond sheets 
	Fibre-reinforced plastics (GRP/CRP)	Deburring, chamfering and breaking of edges	Diamond machinist's files, grit size D 251 
<b>Grinding</b>   	Tungsten carbide, ceramics, glass, ferrite (magnetic material), nickel-based and titanium-based alloys	Grinding of bores, radii, contours, profiles and shoulders, as well as deburring and chamfering	Electroplated diamond grinding points 
			Diamond grinding disc CC-GRIND SOLID DIAMOND 
		Internal grinding of bores	Electroplated diamond grinding points, cylindrical shape ZY Electroplated diamond grinding discs 
	Tungsten carbide	Sharpening of tungsten carbide tools	Resinoid-bonded diamond grinding discs 
	Hardened steels from approx. 54 HRC	Grinding of bores, radii, contours, profiles and shoulders, as well as deburring and chamfering	Electroplated CBN grinding points 
			Electroplated CBN grinding points, cylindrical shape ZY Electroplated CBN grinding discs 
		HSS (High Speed Steel)	Sharpening of HSS tools
	Fibre-reinforced plastics (GRP/CRP)	Deburring, chamfering and general grinding work	Electroplated diamond grinding points, cylindrical shape with radius end WR, grit size D357 Diamond grinding disc CC-GRIND SOLID DIAMOND 
			Mounted points for foundries 
	<b>Cutting</b> 	Tungsten carbide, ceramics, glass, ferrite, nickel-based and titanium-based alloys	Cutting
Diamond cut-off wheels, grit size D 357/D 427 			
Fibre-reinforced plastics (GRP/CRP)		Cut-off grinding, trimming, making cut-outs, and cutting straight contours to size	Diamond cut-off wheels, grit size D 357/D 427 
			Diamond sabre saw blades 
Grey and nodular cast iron	Separation of open risers, burrs, feeders, sprues, parting lines etc.	Diamond cut-off wheels, grit size D 852 	

### Materials

Diamond and CBN abrasives are used when materials cannot be machined with conventional abrasives such as aluminium oxide or silicon carbide. They also provide a more economical solution for many applications. Due to high chemical wear, rotating diamond tools are not suitable for work on steel. CBN tools are used for these applications. The two abrasives complement each other ideally. In the adjacent overview, you will find various materials associated with the abrasives.

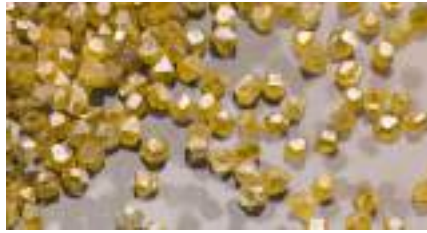

#### Diamond

- Duroplastics, in particular with glass or carbon fibre reinforcement (GRP and CRP)
- Ferrite (magnetic material)
- Glass
- Graphite and synthetic carbon
- Grey and nodular cast iron
- Tungsten carbide
- Nickel or titanium-based superalloys
- Technical ceramics
- Wear-resistant coatings (powder metal alloys and hardfacing alloys)



#### CBN

- Case-hardened steels
- Roller-bearing and ball-bearing steels
- Tool steels
- Other hardened steel materials with a hardness from approx. 54 HRC

## Customer-specific tool solutions

### 1. Process analysis and tool development

Contact us at [www.pferd.com](http://www.pferd.com) and arrange an appointment with our experienced sales representatives and technical advisers.

If you already have precise ideas about the desired tool, you can provide us with a technical drawing or a dimensioned sketch and information on the desired abrasives and grit sizes.

Our employees **will analyze your application with you on-site** and develop the most economic individual tool solution for you. You will then immediately receive a quote. Three production variants are possible:

### 2. Production

#### ■ Complete production

From design and construction, through manufacture of the tool blank (steel, stainless steel or brass) and its coating with diamond or CBN grit, to the balancing of the finished tool, PFERD offers you all the production steps from a single source. This guarantees you the highest level of quality, flexibility and on-time delivery.

#### ■ Coating

Steel, stainless steel or brass blanks provided by the customer can also be coated with diamond or CBN grit. Close cooperation at an early stage is recommended.

#### ■ Recoating

PFERD offers recoating of blunt tools with steel or stainless steel blanks as an economical alternative to replacement production. Tools with brass blanks cannot be recoated.

### 3. Use

Our flexible production and global logistics network ensure that you receive your new tool on time.

If desired, your personal sales representative and a technical adviser will set up all the process parameters together with you.

**See the quality, performance and economic value of PFERD tools for yourself!**



# Diamond and CBN tools

## Safety notes and recommended cutting speeds

### Safety notes

The operator is responsible for the grinding application, including correct tool drive use, correct handling and use of the grinding tools.



Wear eye protection!



Wear hearing protection!



Wear gloves!



Wear a dust mask!



Follow the safety instructions!

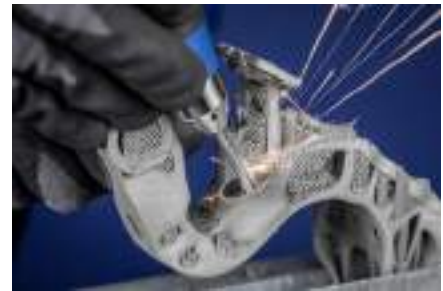

### Recommended cutting speeds

The recommended cutting speed ranges depend on the application and must not exceed the maximum permissible peripheral speed. Because of the wide range of tasks and application fields of electroplated diamond and CBN tools, as well as the large influence of the employed tool drive, it is not possible to specify a generally valid cutting speed. The recommended cutting speed ranges serve as reference values.

#### Generally, the following applies:

- In dry grinding, do not use diamond tools at too high a cutting speed in order to avoid thermal damage to the abrasive.
- If possible, do not use CBN tools under the cutting speeds specified below. The optimum cutting speed has a direct effect on the economic efficiency of the tools in use.
- All parameters must always be coordinated with each other within the grinding process. If the cutting speed is changed, the feed, infeed and coolant supply, among others, must be adjusted accordingly.
- Electroplated diamond and CBN tools can be used in dedicated stationary applications up to a peripheral speed of 125 m/s.



5

		Cutting speed [m/s] ▶		5	10	15	20	25	30	35	40	45	...	80	
<b>Electroplated bond</b>	Diamond	Dry grinding			8–18 m/s						30–80 m/s for CRP/GRP as well as grey and nodular cast iron				
		Wet grinding				15–25 m/s									
	CBN	Dry grinding				15–25 m/s									
		Wet grinding						20–40 m/s							
<b>Resinoid bond</b>	Diamond	Dry grinding				15–20 m/s									
		Wet grinding					20–30 m/s								
	CBN	Dry grinding					18–30 m/s								
		Wet grinding							25–40 m/s						
<b>Metal bond</b>	Diamond	Dry grinding			10–15 m/s										
		Wet grinding				15–30 m/s									
	CBN	Wet grinding					25–30 m/s								

Tool dia. [mm]	Cutting speed [m/s]											
	8	12	15	18	20	25	30	40	50	80	100	125
	Rotational speed rounded off [RPM]											
1	153,000	-	-	-	-	-	-	-	-	-	-	-
2	76,400	115,000	143,000	172,000	191,000	-	-	-	-	-	-	-
3	50,900	76,400	95,500	115,000	127,000	159,000	191,000	-	-	-	-	-
4	38,200	57,300	71,600	85,900	95,500	119,000	143,000	-	-	-	-	-
5	30,600	45,800	57,300	68,800	76,400	95,500	115,000	153,000	-	-	-	-
6	25,500	38,200	47,700	57,300	63,700	79,600	95,500	127,000	159,000	-	-	-
7	21,800	32,700	40,900	49,100	54,600	68,200	81,900	109,000	136,000	-	-	-
8	19,100	28,600	35,800	43,000	47,700	59,700	71,600	95,500	119,000	191,000	-	-
9	17,000	25,500	31,800	38,200	42,400	53,100	63,700	84,900	106,000	170,000	-	-
10	15,300	22,900	28,600	34,400	38,200	47,700	57,300	76,400	95,500	153,000	191,000	-
12	12,700	19,100	23,900	28,600	31,800	39,800	47,700	63,700	79,600	127,000	159,000	199,000
14	10,900	16,400	20,500	24,600	27,300	34,100	40,900	54,600	68,200	109,000	136,000	171,000
15	10,200	15,300	19,100	22,900	25,500	31,800	38,200	50,900	63,700	102,000	127,000	159,000
16	9,500	14,300	17,900	21,500	23,900	29,800	35,800	47,700	59,700	95,500	119,000	149,000
18	8,500	12,700	15,900	19,100	21,200	26,500	31,800	42,400	53,100	84,900	106,000	133,000
20	7,600	11,500	14,300	17,200	19,100	23,900	28,600	38,200	47,700	76,400	95,500	119,000
22	6,900	10,400	13,000	15,600	17,400	21,700	26,000	34,700	43,400	69,400	86,800	109,000
25	6,100	9,200	11,500	13,800	15,300	19,100	22,900	30,600	38,200	61,100	76,400	95,500
30	5,100	7,600	9,500	11,500	12,700	15,900	19,100	25,500	31,800	50,900	63,700	79,600
40	3,800	5,700	7,200	8,600	9,500	11,900	14,300	19,100	23,900	38,200	47,700	59,700
50	3,100	4,600	5,700	6,900	7,600	9,500	11,500	15,300	19,100	30,600	38,200	47,700
75	2,000	3,100	3,800	4,600	5,100	6,400	7,600	10,200	12,700	20,400	25,500	31,800
100	1,530	2,300	2,900	3,400	3,800	4,800	5,700	7,600	9,500	15,300	19,100	23,900
125	1,220	1,830	2,300	2,800	3,100	3,800	4,600	6,100	7,600	12,200	15,300	19,100
150	1,020	1,530	1,910	2,300	2,500	3,200	3,800	5,100	6,400	10,200	12,700	15,900
175	870	1,310	1,640	1,960	2,200	2,700	3,300	4,400	5,500	8,700	10,900	13,600
200	760	1,150	1,430	1,720	1,910	2,400	2,900	3,800	4,800	7,600	9,500	11,900
230	660	1,000	1,250	1,490	1,660	2,100	2,500	3,300	4,200	6,600	8,300	10,400
250	610	920	1,150	1,380	1,530	1,910	2,300	3,100	3,800	6,100	7,600	9,500
300	510	760	950	1,150	1,270	1,590	1,910	2,500	3,200	5,100	6,400	8,000
350	440	650	820	980	1,090	1,360	1,640	2,200	2,700	4,400	5,500	6,800
400	380	570	720	860	950	1,190	1,430	1,910	2,400	3,800	4,800	6,000
450	340	510	640	760	850	1,060	1,270	1,700	2,100	3,400	4,200	5,300
500	310	460	570	690	760	950	1,150	1,530	1,910	3,100	3,800	4,800
600	250	380	480	570	640	800	950	1,270	1,590	2,500	3,200	4,000

Refer to the table for the recommended rotational speed based on the diameter and cutting speed of your tool.

**Example:**

Diamond grinding point, diameter: 20 mm

Cutting speed: 25 m/s

**Rotational speed rounded: 23,900 RPM**

# Diamond and CBN tools – electroplated bond

## Diamond escapement files



### Diamond escapement files, half-round

Diamond escapement files are used on very small shapes in tool making and in precision mechanics. They have a forged shank which allows use without an additional handle. Grit sizes D 25 and D 46 provide ultra-fine surface finishes.

**Special features:**

- Ideal for work on hardened steel.
- No chemical wear thanks to the low working temperatures.
- Longer tool life due to harder diamond grain.

Profile	Width with coating [mm]	Height with coating [mm]	Total length [mm]	Coating length [mm]	Grit size		Item no.	Designation	Price/unit EUR
Half-round	4.2	1.5	140	40	D 25	1	15308143	DF 3608 D 25	-
					D 46	1	15308140	DF 3608 D 46	-
					D 91	1	15308141	DF 3608 D 91	-
					D 126	1	15308142	DF 3608 D 126	-



### Diamond escapement files, crossing oval

Diamond escapement files are used on very small shapes in tool making and in precision mechanics. They have a forged shank which allows use without an additional handle. Grit sizes D 25 and D 46 provide ultra-fine surface finishes.

**Special features:**

- Ideal for work on hardened steel.
- No chemical wear thanks to the low working temperatures.
- Longer tool life due to harder diamond grain.

Profile	Width with coating [mm]	Height with coating [mm]	Total length [mm]	Coating length [mm]	Grit size		Item no.	Designation	Price/unit EUR
Crossing oval shape	3.8	1.8	140	40	D 25	1	15309143	DF 3609 D 25	-
					D 91	1	15309141	DF 3609 D 91	-
					D 126	1	15309142	DF 3609 D 126	-



### Diamond escapement files, barrette

Diamond escapement files are used on very small shapes in tool making and in precision mechanics. They have a forged shank which allows use without an additional handle. Grit sizes D 25 and D 46 provide ultra-fine surface finishes.

**Special features:**

- Ideal for work on hardened steel.
- No chemical wear thanks to the low working temperatures.
- Longer tool life due to harder diamond grain.

Profile	Width with coating [mm]	Height with coating [mm]	Total length [mm]	Coating length [mm]	Grit size		Item no.	Designation	Price/unit EUR
Barrette shape	4	1.2	140	40	D 25	1	15310143	DF 3610 D 25	-
					D 46	1	15310140	DF 3610 D 46	-
					D 91	1	15310141	DF 3610 D 91	-
					D 126	1	15310142	DF 3610 D 126	-





### Diamond escapement files, three square

Diamond escapement files are used on very small shapes in tool making and in precision mechanics. They have a forged shank which allows use without an additional handle. Grit sizes D 25 and D 46 provide ultra-fine surface finishes.

**Special features:**

- Ideal for work on hardened steel.
- No chemical wear thanks to the low working temperatures.
- Longer tool life due to harder diamond grain.



Profile	Width with coating [mm]	Total length [mm]	Coating length [mm]	Grit size		Item no.	Designation	Price/unit EUR
Three square	3	140	40	D 25	1	15314143	DF 3614 D 25	-
				D 46	1	15314140	DF 3614 D 46	-
				D 91	1	15314141	DF 3614 D 91	-
				D 126	1	15314142	DF 3614 D 126	-

### Diamond escapement files, hand

Diamond escapement files are used on very small shapes in tool making and in precision mechanics. They have a forged shank which allows use without an additional handle. Grit sizes D 25 and D 46 provide ultra-fine surface finishes.

**Special features:**

- Ideal for work on hardened steel.
- No chemical wear thanks to the low working temperatures.
- Longer tool life due to harder diamond grain.



Profile	Width with coating [mm]	Height with coating [mm]	Total length [mm]	Coating length [mm]	Grit size		Item no.	Designation	Price/unit EUR
Hand	4	1.2	140	40	D 25	1	15317143	DF 3617 D 25	-
					D 46	1	15317140	DF 3617 D 46	-
					D 91	1	15317141	DF 3617 D 91	-
					D 126	1	15317142	DF 3617 D 126	-

### Diamond escapement files, square

Diamond escapement files are used on very small shapes in tool making and in precision mechanics. They have a forged shank which allows use without an additional handle. Grit sizes D 25 and D 46 provide ultra-fine surface finishes.

**Special features:**

- Ideal for work on hardened steel.
- No chemical wear thanks to the low working temperatures.
- Longer tool life due to harder diamond grain.



Profile	Width with coating [mm]	Height with coating [mm]	Total length [mm]	Coating length [mm]	Grit size		Item no.	Designation	Price/unit EUR
Square	2	2	140	40	D 25	1	15319143	DF 3619 D 25	-
					D 46	1	15319140	DF 3619 D 46	-
					D 91	1	15319141	DF 3619 D 91	-
					D 126	1	15319142	DF 3619 D 126	-

# Diamond and CBN tools – electroplated bond

## Diamond escapement files



### Diamond escapement files, round

Diamond escapement files are used on very small shapes in tool making and in precision mechanics. They have a forged shank which allows use without an additional handle. Grit sizes D 25 and D 46 provide ultra-fine surface finishes.

**Special features:**

- Ideal for work on hardened steel.
- No chemical wear thanks to the low working temperatures.
- Longer tool life due to harder diamond grain.

Profile	Width with coating [mm]	Total length [mm]	Coating length [mm]	Grit size		Item no.	Designation	Price/unit EUR
Round	1.8	140	40	D 25	1	15321143	DF 3621 D 25	-
				D 46	1	15321140	DF 3621 D 46	-
				D 91	1	15321141	DF 3621 D 91	-
				D 126	1	15321142	DF 3621 D 126	-



### Diamond escapement file sets

Diamond escapement file sets are supplied in a sturdy, practical plastic box which protects the tools from damage. This is ideal for keeping in the tool trolley or workbench.

**Contents:**

Contains one each of the following escapement files: DF 3608 (half-round), DF 3614 (three square), DF 3617 (hand), DF 3619 (square) and DF 3621 (round).

- No chemical wear thanks to the low working temperatures.
- Longer tool life due to harder diamond grain.

**Special features:**

- Ideal for work on hardened steel.

Grit size		Item no.	Designation	Price/unit EUR
D 25	1	15830903	DF 3090 D 25	-
D 46	1	15830900	DF 3090 D 46	-
D 91	1	15830901	DF 3090 D 91	-
D 126	1	15830902	DF 3090 D 126	-

## Diamond needle files



### Diamond needle files, hand

Diamond needle files can be used generally in tool making. Diamond needle files in extra-slim design (S) are particularly suitable for work on deep-set, narrow contours.

**Special features:**

- Ideal for work on hardened steel.
- No chemical wear thanks to the low working temperatures.
- Longer tool life due to harder diamond grain.

Profile	Width with coating [mm]	Height with coating [mm]	Total length [mm]	Coating length [mm]	Grit size		Item no.	Designation	Price/unit EUR
<b>Needle files, extra slim (S)</b>									
Hand, ultra-slim	5.3	1.3	140	70	D 126	1	15102082	DF 4112S D 126	-
<b>Needle files</b>									
Hand	5.5	1.6	140	70	D 91	1	15101061	DF 4112 D 91	-
					D 126	1	15101062	DF 4112 D 126	-
					D 181	1	15101063	DF 4112 D 181	-



### Diamond needle files, hand with rounded edges

Diamond needle files can be used generally in tool making.

**Special features:**

- Ideal for work on hardened steel.
- No chemical wear thanks to the low working temperatures.
- Longer tool life due to harder diamond grain.

Profile	Width with coating [mm]	Height with coating [mm]	Total length [mm]	Coating length [mm]	Grit size		Item no.	Designation	Price/unit EUR
Hand with round edges	5.5	1.6	140	70	D 91	1	15102061	DF 4112R D 91	-
					D 126	1	15102062	DF 4112R D 126	-
					D 181	1	15102063	DF 4112R D 181	-



### Diamond needle files, flat

Diamond needle files can be used generally in tool making.

**Special features:**

- Ideal for work on hardened steel.
- No chemical wear thanks to the low working temperatures.
- Longer tool life due to harder diamond grain.

Profile	Width with coating [mm]	Height with coating [mm]	Total length [mm]	Coating length [mm]	Grit size		Item no.	Designation	Price/unit EUR
Flat	5.5	1.6	140	70	D 91	1	15103061	DF 4122 D 91	-
					D 126	1	15103062	DF 4122 D 126	-
					D 181	1	15103063	DF 4122 D 181	-



### Diamond needle files, three square

Diamond needle files can be used generally in tool making. Diamond needle files in extra-slim design (S) are particularly suitable for work on deep-set, narrow contours.

**Special features:**

- Ideal for work on hardened steel.
- No chemical wear thanks to the low working temperatures.
- Longer tool life due to harder diamond grain.

Profile	Width with coating [mm]	Total length [mm]	Coating length [mm]	Grit size		Item no.	Designation	Price/unit EUR
Three square, ultra-slim	2.8	140	70	D 126	1	15104082	DF 4132S D 126	-
Three square	3.5	140	70	D 91	1	15104061	DF 4132 D 91	-
				D 126	1	15104062	DF 4132 D 126	-
				D 181	1	15104063	DF 4132 D 181	-





### Diamond needle files, square

Diamond needle files can be used generally in tool making. Diamond needle files in extra-slim design (S) are particularly suitable for work on deep-set, narrow contours.

**Special features:**

- Ideal for work on hardened steel.
- No chemical wear thanks to the low working temperatures.
- Longer tool life due to harder diamond grain.

Profile	Width with coating [mm]	Total length [mm]	Coating length [mm]	Grit size		Item no.	Designation	Price/unit EUR
Square, ultra-slim	2.3	140	70	D 126	1	15105082	DF 4142S D 126	-
Square	2.6	140	70	D 91	1	15105061	DF 4142 D 91	-
				D 126	1	15105062	DF 4142 D 126	-
				D 181	1	15105063	DF 4142 D 181	-



### Diamond needle files, half-round

Diamond needle files can be used generally in tool making.

**Special features:**

- Ideal for work on hardened steel.
- No chemical wear thanks to the low working temperatures.
- Longer tool life due to harder diamond grain.

Profile	Width with coating [mm]	Height with coating [mm]	Total length [mm]	Coating length [mm]	Grit size		Item no.	Designation	Price/unit EUR
Half-round	5.5	1.6	140	70	D 91	1	15106061	DF 4152 D 91	-
					D 126	1	15106062	DF 4152 D 126	-
					D 181	1	15106063	DF 4152 D 181	-



### Diamond needle files, round

Diamond needle files can be used generally in tool making. Diamond needle files in extra-slim design (S) are particularly suitable for work on deep-set, narrow contours.

**Special features:**

- Ideal for work on hardened steel.
- No chemical wear thanks to the low working temperatures.
- Longer tool life due to harder diamond grain.

Profile	Width with coating [mm]	Total length [mm]	Coating length [mm]	Grit size		Item no.	Designation	Price/unit EUR
Round, ultra-slim	2.8	140	70	D 126	1	15107082	DF 4162S D 126	-
Round	3.2	140	70	D 91	1	15107061	DF 4162 D 91	-
				D 126	1	15107062	DF 4162 D 126	-
				D 181	1	15107063	DF 4162 D 181	-



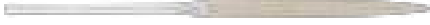

### Diamond needle files, knife

Diamond needle files can be used generally in tool making.

**Special features:**

- Ideal for work on hardened steel.
- No chemical wear thanks to the low working temperatures.
- Longer tool life due to harder diamond grain.

Profile	Width with coating [mm]	Height with coating [mm]	Total length [mm]	Coating length [mm]	Grit size		Item no.	Designation	Price/unit EUR
Knife shape	5	1.8	140	70	D 91	1	15108061	DF 4172 D 91	-
					D 126	1	15108062	DF 4172 D 126	-
					D 181	1	15108063	DF 4172 D 181	-



### Diamond needle files, feather edge

Diamond needle files can be used generally in tool making.

**Special features:**

- Ideal for work on hardened steel.
- No chemical wear thanks to the low working temperatures.
- Longer tool life due to harder diamond grain.

Profile	Width with coating [mm]	Height with coating [mm]	Total length [mm]	Coating length [mm]	Grit size		Item no.	Designation	Price/unit EUR
Feather edge	5	2.4	140	70	D 91	1	15109061	DF 4182 D 91	-
					D 126	1	15109062	DF 4182 D 126	-



### Diamond needle files, crossing oval

Diamond needle files can be used generally in tool making.

**Special features:**

- Ideal for work on hardened steel.
- No chemical wear thanks to the low working temperatures.
- Longer tool life due to harder diamond grain.

Profile	Width with coating [mm]	Height with coating [mm]	Total length [mm]	Coating length [mm]	Grit size		Item no.	Designation	Price/unit EUR
Crossing oval shape	5	2.2	140	70	D 91	1	15110061	DF 4192 D 91	-
					D 126	1	15110062	DF 4192 D 126	-



### Diamond needle files, barrette

Diamond needle files can be used generally in tool making.

**Special features:**

- Ideal for work on hardened steel.
- No chemical wear thanks to the low working temperatures.
- Longer tool life due to harder diamond grain.

Profile	Width with coating [mm]	Height with coating [mm]	Total length [mm]	Coating length [mm]	Grit size		Item no.	Designation	Price/unit EUR
Barrette shape	5	2	140	70	D 91	1	15100061	DF 4102 D 91	-
					D 126	1	15100062	DF 4102 D 126	-



# Diamond and CBN tools – electroplated bond

## Diamond needle files



### Diamond needle file sets

Diamond needle file sets are supplied in a sturdy, practical plastic box which protects the tools from damage. This is ideal for keeping in the tool trolley or workbench.

#### Contents:

The **DF 4205 needle file set** contains one each of the following needle files: DF 4112 (hand), DF 4132 (three square), DF 4142 (square), DF 4152 (half-round) and DF 4162 (round).

The **DF 4211 needle file set** contains one each of the following needle files: DF 4112 (hand), DF 4112R (hand with round edges), DF 4122 (flat), DF 4132 (three square),

DF 4142 (square), DF 4152 (half-round), DF 4162 (round), DF 4172 (knife), DF 4182 (feather edge), DF 4192 (crossing oval) and DF 4102 (barrette).

#### Special features:

- Ideal for work on hardened steel.
- No chemical wear thanks to the low working temperatures.
- Longer tool life due to harder diamond grain.

Grit size		Item no.	Designation	Price/unit EUR
D 91	1	15842051	DF 4205 D 91	-
D 126	1	15842052	DF 4205 D 126	-
D 181	1	15842053	DF 4205 D 181	-
D 91	1	15842111	DF 4211 D 91	-
D 126	1	15842112	DF 4211 D 126	-
D 181	1	15842113	DF 4211 D 181	-

## Diamond riffler files

5

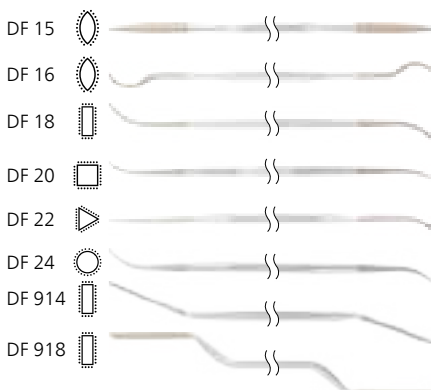

### Diamond riffler files

Diamond riffler files are used for work in hard-to-reach areas and on complex geometries. The coating length is 25 mm on both sides of the files.

#### Special features:

- Ideal for work on hardened steel.
- No chemical wear thanks to the low working temperatures.
- Longer tool life due to harder diamond grain.

Profile	Width with coating [mm]	Height with coating [mm]	Total length [mm]	Double-sided coating length [mm]	Grit size		Item no.	Designation	Price/unit EUR
Crossing oval shape	3.2	2	150	25	D 91	1	15215070	DF 15 D 91	-
					D 126	1	15215100	DF 15 D 126	-
Hand	3.1	3	150	25	D 91	1	15216070	DF 16 D 91	-
					D 126	1	15216100	DF 16 D 126	-
Square	2.5	2.5	150	25	D 91	1	15218070	DF 18 D 91	-
					D 126	1	15218100	DF 18 D 126	-
Three square	3	-	150	25	D 91	1	15220070	DF 20 D 91	-
					D 126	1	15220100	DF 20 D 126	-
Round	3	-	150	25	D 91	1	15222070	DF 22 D 91	-
					D 126	1	15222100	DF 22 D 126	-
Hand	3.8	1.6	150	25	D 91	1	15224070	DF 24 D 91	-
					D 126	1	15224100	DF 24 D 126	-
Hand	4	2	150	25	D 91	1	15209141	DF 914 D 91	-
					D 126	1	15209142	DF 914 D 126	-
					D 91	1	15209181	DF 918 D 91	-
					D 126	1	15209182	DF 918 D 126	-



### Diamond riffler file set

The diamond riffler file set is supplied in a sturdy, practical plastic box which protects the tools from damage. This is ideal for keeping in the tool trolley or workbench.



#### Contents:

Contains one each of the following riffler files: DF 16 (crossing oval), DF 18 (hand), DF 20 (square), DF 22 (three square), DF 24 (round).

#### Special features:

- Sturdy plastic box to prevent damage.

Grit size		Item no.	Designation	Price/unit EUR
D 126	1	15816242	DF 1624 D 126	-

## Diamond handy files



### Diamond handy files, hand

Diamond handy files have a forged shank which allows for use without an additional handle.

#### Special features:

- Ideal for work on hardened steel.
- No chemical wear thanks to the low working temperatures.
- Longer tool life due to harder diamond grain.

Profile	Width with coating [mm]	Height with coating [mm]	Total length [mm]	Coating length [mm]	Grit size		Item no.	Designation	Price/unit EUR
Hand	10.3	2.8	215	100	D 126	1	15430202	DF 2601 D 126	-
					D 181	1	15430203	DF 2601 D 181	-



### Diamond handy files, half-round

Diamond handy files have a forged shank which allows for use without an additional handle.

#### Special features:

- Ideal for work on hardened steel.
- No chemical wear thanks to the low working temperatures.
- Longer tool life due to harder diamond grain.

Profile	Width with coating [mm]	Height with coating [mm]	Total length [mm]	Coating length [mm]	Grit size		Item no.	Designation	Price/unit EUR
Half-round	12.5	3.8	215	100	D 126	1	15431202	DF 2602 D 126	-
					D 181	1	15431203	DF 2602 D 181	-



### Diamond handy files, three square

Diamond handy files have a forged shank which allows for use without an additional handle.

#### Special features:

- Ideal for work on hardened steel.
- No chemical wear thanks to the low working temperatures.
- Longer tool life due to harder diamond grain.

Profile	Width with coating [mm]	Total length [mm]	Coating length [mm]	Grit size		Item no.	Designation	Price/unit EUR
Three square	10	215	100	D 126	1	15432202	DF 2607 D 126	-
				D 181	1	15432203	DF 2607 D 181	-



# Diamond and CBN tools – electroplated bond

## Diamond handy files



### Diamond handy files, square

Diamond handy files have a forged shank which allows for use without an additional handle.

**Special features:**

- Ideal for work on hardened steel.
- No chemical wear thanks to the low working temperatures.
- Longer tool life due to harder diamond grain.

Profile	Width with coating [mm]	Height with coating [mm]	Total length [mm]	Coating length [mm]	Grit size		Item no.	Designation	Price/unit EUR
Square	5.5	5.5	215	100	D 126	1	15433202	DF 2608 D 126	-
					D 181	1	15433203	DF 2608 D 181	-



### Diamond handy files, round

Diamond handy files have a forged shank which allows for use without an additional handle.

**Special features:**

- Ideal for work on hardened steel.
- No chemical wear thanks to the low working temperatures.
- Longer tool life due to harder diamond grain.

Profile	Width with coating [mm]	Total length [mm]	Coating length [mm]	Grit size		Item no.	Designation	Price/unit EUR
Round	6.7	215	100	D 126	1	15434202	DF 2610 D 126	-
				D 181	1	15434203	DF 2610 D 181	-

5



### Diamond handy file sets

Diamond handy file sets are supplied in a sturdy, practical plastic box which protects the tools from damage. This is ideal for keeping in the tool trolley or workbench.

**Contents:**

Contains one each of the following handy files: DF 2601 (hand), DF 2602 (half-round), DF 2607 (three square), DF 2608 (square) and DF 2610 (round).

**Special features:**

- Ideal for work on hardened steel.
- No chemical wear thanks to the low working temperatures.
- Longer tool life due to harder diamond grain.

Grit size		Item no.	Designation	Price/unit EUR
D 126	1	15826272	DF 2627 D 126	-
D 181	1	15826273	DF 2627 D 181	-





### Conical diamond files

The conical diamond files are used in tool-making for particularly narrow, deep-set contours. The forged shank allows for use without an additional handle.

#### Special features:

- Ideal for work on hardened steel.
- No chemical wear thanks to the low working temperatures.
- Longer tool life due to harder diamond grain.

Width A [mm]	Thickness B [mm]	Thickness B <sub>1</sub> [mm]	Total length [mm]	Coating length [mm]	Grit size		Item no.	Designation	Price/unit EUR
4	2	0.5	170	50	D 46	1	15917040	DF-K 170-4-2-0,5 D 46	-
					D 91	1	15917041	DF-K 170-4-2-0,5 D 91	-
					D 126	1	15917042	DF-K 170-4-2-0,5 D 126	-
6	2.4	0.5	170	50	D 46	1	15917060	DF-K 170-6-2,4-0,5 D 46	-
					D 91	1	15917061	DF-K 170-6-2,4-0,5 D 91	-
					D 126	1	15917062	DF-K 170-6-2,4-0,5 D 126	-
8	2.4	0.5	170	50	D 46	1	15917080	DF-K 170-8-2,4-0,5 D 46	-
					D 91	1	15917081	DF-K 170-8-2,4-0,5 D 91	-
					D 126	1	15917082	DF-K 170-8-2,4-0,5 D 126	-
10	2.5	0.5	170	50	D 46	1	15917100	DF-K 170-10-2,5-0,5 D 46	-
					D 91	1	15917101	DF-K 170-10-2,5-0,5 D 91	-
					D 126	1	15917102	DF-K 170-10-2,5-0,5 D 126	-

## Diamond machinist's files

5



### Diamond machinist's files, hand

Diamond machinist's files are used in many industries, such as the manufacturing of large tools. Grit size D 251 is also suitable for work on fibre-reinforced plastics (GRP/CRP). Diamond machinist's files are supplied with ergonomic file handles.

#### Special features:

- Ideal for work on hardened steel.
- No chemical wear thanks to the low working temperatures.
- Longer tool life due to harder diamond grain.

Profile	Width with coating [mm]	Height with coating [mm]	Total length [mm]	Coating length [mm]	Grit size		Item no.	Designation	Price/unit EUR
Hand	10	3.2	100	85	D 126	1	15400126	DF 1112/100 D 126	-
					D 151	1	15400151	DF 1112/100 D 151	-
					D 251	1	15400251	DF 1112/100 D 251	-
	11.2	4.2	125	110	D 126	1	15401126	DF 1112/125 D 126	-
					D 151	1	15401151	DF 1112/125 D 151	-
					D 251	1	15401199	DF 1112/150 D 251	-
	13	5	150	135	D 126	1	15401192	DF 1112/150 D 126	-
					D 151	1	15401195	DF 1112/150 D 151	-
D 251					1	15401205	DF 1112/200 D 251	-	
22.5	5.5	200	180	D 151	1	15401204	DF 1112/200 D 151	-	
				D 251	1	15401205	DF 1112/200 D 251	-	

# Diamond and CBN tools – electroplated bond

## Diamond machinist's files

PFERD



### Diamond machinist's files, three square

Diamond machinist's files are used in many industries, such as the manufacturing of large tools. Grit size D 251 is also suitable for work on fibre-reinforced plastics (GRP/CRP). Diamond machinist's files are supplied with ergonomic file handles.

**Special features:**

- Ideal for work on hardened steel.
- No chemical wear thanks to the low working temperatures.
- Longer tool life due to harder diamond grain.

Profile	Width with coating [mm]	Total length [mm]	Coating length [mm]	Grit size		Item no.	Designation	Price/unit EUR
Three square	7	100	85	D 126	1	15403126	DF 1132/100 D 126	-
				D 151	1	15403151	DF 1132/100 D 151	-
	14	200	180	D 151	1	15403204	DF 1132/200 D 151	-
				D 251	1	15403205	DF 1132/200 D 251	-



### Diamond machinist's files, square

Diamond machinist's files are used in many industries, such as the manufacturing of large tools. Grit size D 251 is also suitable for work on fibre-reinforced plastics (GRP/CRP). Diamond machinist's files are supplied with ergonomic file handles.

**Special features:**

- Ideal for work on hardened steel.
- No chemical wear thanks to the low working temperatures.
- Longer tool life due to harder diamond grain.

Profile	Width with coating [mm]	Height with coating [mm]	Total length [mm]	Coating length [mm]	Grit size		Item no.	Designation	Price/unit EUR
Square	7.5	7.5	200	180	D 151	1	15404204	DF 1142/200 D 151	-



### Diamond machinist's files, half-round pointed

Diamond machinist's files are used in many industries, such as the manufacturing of large tools. Grit size D 251 is also suitable for work on fibre-reinforced plastics (GRP/CRP). Diamond machinist's files are supplied with ergonomic file handles.

**Special features:**

- Ideal for work on hardened steel.
- No chemical wear thanks to the low working temperatures.
- Longer tool life due to harder diamond grain.

Profile	Width with coating [mm]	Height with coating [mm]	Total length [mm]	Coating length [mm]	Grit size		Item no.	Designation	Price/unit EUR
Half-round pointed	12	4	100	85	D 126	1	15405126	DF 1152/100 D 126	-
					D 151	1	15405151	DF 1152/100 D 151	-
	22	6.5	200	180	D 151	1	15405204	DF 1152/200 D 151	-
					D 251	1	15405205	DF 1152/200 D 251	-



### Diamond machinist's files, round

Diamond machinist's files are used in many industries, such as the manufacturing of large tools. Grit size D 251 is also suitable for work on fibre-reinforced plastics (GRP/CRP). Diamond machinist's files are supplied with ergonomic file handles.

**Special features:**

- Ideal for work on hardened steel.
- No chemical wear thanks to the low working temperatures.
- Longer tool life due to harder diamond grain.

Profile	Width with coating [mm]	Total length [mm]	Coating length [mm]	Grit size		Item no.	Designation	Price/unit EUR
Round	8	200	180	D 151	1	15406204	DF 1162/200 D 151	-



### Flexible diamond files

The flexible diamond files perfectly adapt to the workpiece surface. Due to its flexibility, they can be used in convex and concave contours with small radii.



#### Special features:

- Ideal for work on hardened steel.
- No chemical wear thanks to the low working temperatures.
- Longer tool life due to harder diamond grain.

Width with coating [mm]	Height with coating [mm]	Total length [mm]	Coating	Grit size		Item no.	Designation	Price/unit EUR
0.5	14	165	one side	D 76	5	15600076	DF-FLEX 14-165 D 76	-
				D 126	5	15600126	DF-FLEX 14-165 D 126	-
				D 181	5	15600181	DF-FLEX 14-165 D 181	-

## Diamond sheets



### Diamond sheets

The diamond sheets are exceptionally well-suited to work on larger surfaces. Convex and concave contours can be worked on with relatively little effort.

#### Special features:

- Ideal for work on hardened steel.
- No chemical wear thanks to the low working temperatures.
- Longer tool life due to harder diamond grain.

Width with coating [mm]	Height with coating [mm]	Total length [mm]	Coating	Grit size		Item no.	Designation	Price/unit EUR
0.7	30	170	complete	D 64	1	15600030	DBL 30-0,7-170 D 64	-
				D 126	1	15630126	DBL 30-0,7-170 D 126	-
1.3	35	350	complete	D 64	1	15635064	DBL 35-1,3-350 D 64	-
				D 126	1	15600035	DBL 35-1,3-350 D 126	-



# Diamond and CBN tools – electroplated bond

## Diamond files for manual filing tools



### Diamond files for manual filing tools

Diamond files for manual filing tools are suitable for use in machines, as well as for hand filing. The shank diameter of the diamond files is 3 mm.

DF 5301–5309		DF 5365–5375	
DF 5310–5314		DF 5352–5362	
DF 5316		DF 5380–5382	
DF 5390–5392		DF 0103, DF 0106	
DF 5331–5347			

#### Special features:

- Ideal for work on hardened steel.
- No chemical wear thanks to the low working temperatures.
- Longer tool life due to harder diamond grain.

Profile	Width with coating [mm]	Height with coating [mm]	Total length [mm]	Double-sided coating length [mm]	Coating	Grit size		Item no.	Designation	Price/unit EUR
Hand	3	1	50	15	one side	D 126	1	15653032	DF 5303 D 126	-
	4	1	50	15	one side	D 126	1	15653052	DF 5305 D 126	-
	5	2	50	15	one side	D 126	1	15653072	DF 5307 D 126	-
			60	25	one side	D 126	1	15653092	DF 5309 D 126	-
	2	1	50	15	both sides	D 126	1	15653102	DF 5310 D 126	-
	3	1	50	15	both sides	D 126	1	15653112	DF 5311 D 126	-
	4	1	50	15	both sides	D 126	1	15653122	DF 5312 D 126	-
	5	2	50	15	both sides	D 126	1	15653132	DF 5313 D 126	-
60			25	both sides	D 126	1	15653142	DF 5314 D 126	-	
Round	0.5	4	50	15	face-down	D 126	1	15653162	DF 5316 D 126	-
	1	-	50	15	complete	D 126	1	15653312	DF 5331 D 126	-
			60	25	complete	D 126	1	15653352	DF 5335 D 126	-
	2	-	50	15	complete	D 126	1	15653372	DF 5337 D 126	-
			60	25	complete	D 126	1	15653392	DF 5339 D 126	-
	3	-	50	15	complete	D 126	1	15653432	DF 5343 D 126	-
			60	25	complete	D 126	1	15653452	DF 5345 D 126	-
	4	-	50	15	complete	D 126	1	15653472	DF 5347 D 126	-
60			25	complete	D 126	1	15653522	DF 5352 D 126	-	
Crossing oval shape	2	1	50	15	complete	D 126	1	15653562	DF 5356 D 126	-
	3.5	2	50	15	complete	D 126	1	15653622	DF 5362 D 126	-
	6	3	60	25	complete	D 126	1	15653652	DF 5365 D 126	-
Three square	2	-	50	15	complete	D 126	1	15653672	DF 5367 D 126	-
	3.5	-	50	15	complete	D 126	1	15653712	DF 5371 D 126	-
			60	25	complete	D 126	1	15653752	DF 5375 D 126	-
	4.5	-	60	25	complete	D 126	1	15653822	DF 5382 D 126	-
Knife shape	2	6	50	15	complete	D 126	1	15653902	DF 5390 D 126	-
	1.5	1.5	50	15	complete	D 126	1	15653912	DF 5391 D 126	-
			50	15	complete	D 126	1	15653922	DF 5392 D 126	-
Square	3	3	50	15	complete	D 126	1	15601032	DF 0103 D 126	-
	4	4	50	15	complete	D 126	1	15601062	DF 0106/55 D 126	-
	6.3	1	55	16	complete	D 126	1	15601064	DF 0106/73 D 126	-
Flat conical	3.3	1	55	16	complete	D 126	1			
	6.3	1	55	16	complete	D 126	1			
			73	16	complete	D 126	1			





### Cylindrical shape ZY

The cylindrical shape ZY is suitable for grinding bores, radii and contours in stationary or manual applications. Grinding points with a diameter of 8 mm or more have a recess on the front surface.

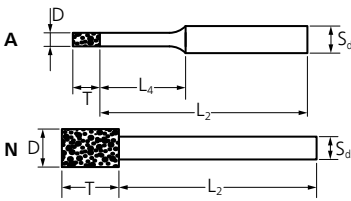

#### Special features:

- Ideal for work on tungsten carbide.
- No chemical wear thanks to the low working temperatures.
- Longer tool life due to harder diamond grain.

D [mm]	T [mm]	S <sub>d</sub> [mm]	L <sub>2</sub> [mm]	L <sub>4</sub> [mm]	Grit size		Item no.	Designation	Price/unit EUR
<b>Shank diameter 3 mm</b>									
0.5	2	3	38	5	D 64	5	36000506	DZY-A 0,5-2/3 D 64	-
0.8	2	3	38	5	D 64	5	36000806	DZY-A 0,8-2/3 D 64	-
1	4	3	36	9	D 64	5	36001006	DZY-A 1,0-4/3 D 64	-
					D 91	5	36001009	DZY-A 1,0-4/3 D 91	-
					D 126	5	36001010	DZY-A 1,0-4/3 D 126	-
1.2	4	3	36	9	D 64	5	36001206	DZY-A 1,2-4/3 D 64	-
					D 91	5	36001209	DZY-A 1,2-4/3 D 91	-
					D 126	5	36001210	DZY-A 1,2-4/3 D 126	-
1.4	4	3	36	9	D 64	5	36001406	DZY-A 1,4-4/3 D 64	-
					D 91	5	36001409	DZY-A 1,4-4/3 D 91	-
					D 126	5	36001410	DZY-A 1,4-4/3 D 126	-
1.6	4	3	36	10	D 91	5	36001609	DZY-A 1,6-4/3 D 91	-
					D 126	5	36001610	DZY-A 1,6-4/3 D 126	-
1.8	4	3	36	10	D 91	5	36001809	DZY-A 1,8-4/3 D 91	-
					D 126	5	36001810	DZY-A 1,8-4/3 D 126	-
2	4	3	36	10	D 64	5	36002006	DZY-A 2,0-4/3 D 64	-
					D 91	5	36002009	DZY-A 2,0-4/3 D 91	-
					D 126	5	36002010	DZY-A 2,0-4/3 D 126	-
2.2	4	3	36	14	D 91	5	36002209	DZY-A 2,2-4/3 D 91	-
2.4	4	3	36	14	D 91	5	36002409	DZY-A 2,4-4/3 D 91	-
					D 126	5	36002410	DZY-A 2,4-4/3 D 126	-
2.6	4	3	36	14	D 91	5	36002609	DZY-A 2,6-4/3 D 91	-
					D 126	5	36002610	DZY-A 2,6-4/3 D 126	-
2.8	4	3	36	14	D 126	5	36002810	DZY-A 2,8-4/3 D 126	-
3	4	3	36	19	D 64	5	36003006	DZY-A 3,0-4/3 D 64	-
					D 91	5	36003009	DZY-A 3,0-4/3 D 91	-
					D 126	5	36003010	DZY-A 3,0-4/3 D 126	-
3.5	5	3	45	-	D 91	5	36003509	DZY-N 3,5-5/3 D 91	-
					D 126	5	36003510	DZY-N 3,5-5/3 D 126	-
4	5	3	45	-	D 91	5	36004009	DZY-N 4,0-5/3 D 91	-
					D 126	5	36004010	DZY-N 4,0-5/3 D 126	-
					D 181	5	36004018	DZY-N 4,0-5/3 D 181	-
4.5	5	3	45	-	D 91	5	36004509	DZY-N 4,5-5/3 D 91	-
					D 126	5	36004510	DZY-N 4,5-5/3 D 126	-
5	5	3	45	-	D 91	5	36005009	DZY-N 5,0-5/3 D 91	-
					D 126	5	36005010	DZY-N 5,0-5/3 D 126	-
5.5	6	3	44	-	D 91	5	36005509	DZY-N 5,5-6/3 D 91	-
					D 126	5	36005510	DZY-N 5,5-6/3 D 126	-
					D 181	5	36005518	DZY-N 5,5-6/3 D 181	-

Continued on next page



# Diamond and CBN tools – electroplated bond

## Diamond grinding points



D [mm]	T [mm]	S <sub>d</sub> [mm]	L <sub>2</sub> [mm]	L <sub>4</sub> [mm]	Grit size		Item no.	Designation	Price/unit EUR
<b>Shank diameter 6 mm</b>									
6	6	6	54	19	D 91	1	36006009	DZY-A 6,0-6/6 D 91	-
					D 126	1	36006010	DZY-A 6,0-6/6 D 126	-
					D 181	1	36006018	DZY-A 6,0-6/6 D 181	-
7	8	6	52	-	D 126	1	36007010	DZY-N 7,0-8/6 D 126	-
8	8	6	52	-	D 91	1	36008009	DZY-N 8,0-8/6 D 91	-
					D 126	1	36008010	DZY-N 8,0-8/6 D 126	-
					D 181	1	36008018	DZY-N 8,0-8/6 D 181	-
9	8	6	52	-	D 126	1	36009010	DZY-N 9,0-8/6 D 126	-
10	8	6	52	-	D 91	1	36010009	DZY-N 10,0-8/6 D 91	-
					D 126	1	36010010	DZY-N 10,0-8/6 D 126	-
					D 181	1	36010018	DZY-N 10,0-8/6 D 181	-
12	8	6	52	-	D 91	1	36012009	DZY-N 12,0-8/6 D 91	-
					D 126	1	36012010	DZY-N 12,0-8/6 D 126	-
					D 181	1	36012018	DZY-N 12,0-8/6 D 181	-
15	10	6	50	-	D 126	1	36015010	DZY-N 15,0-10/6 D 126	-
18	10	6	50	-	D 126	1	36018010	DZY-N 18,0-10/6 D 126	-
20	10	6	50	-	D 126	1	36020010	DZY-N 20,0-10/6 D 126	-
<b>Shank diameter 10 mm</b>									
15	10	10	110	-	D 126	1	36015110	DZY-N 15,0-10/10 D 126	-
<b>Shank diameter 12 mm</b>									
25	10	12	110	-	D 126	1	36025110	DZY-N 25,0-10/12 D 126	-

5

### Special shape ZY

The special shape ZY is suitable for grinding slits and grooves in hard-to-reach areas.



#### Special features:

- Ideal for work on tungsten carbide.
- No chemical wear thanks to the low working temperatures.
- Longer tool life due to harder diamond grain.

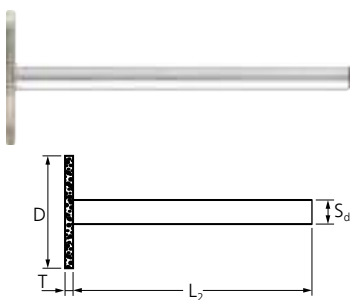

D [mm]	T [mm]	S <sub>d</sub> [mm]	L <sub>2</sub> [mm]	Grit size		Item no.	Designation	Price/unit EUR
<b>Shank diameter 3 mm</b>								
8	0.5	3	35	D 64	1	36050806	DZY-N 8,0-0,5/3 D 64	-
14	0.5	3	35	D 64	1	36051406	DZY-N 14,0-0,5/3 D 64	-
				D 64	1	36051416	DZY-N 14,0-1,0/3 D 64	-
	1	3	35	D 91	1	36051419	DZY-N 14,0-1,0/3 D 91	-

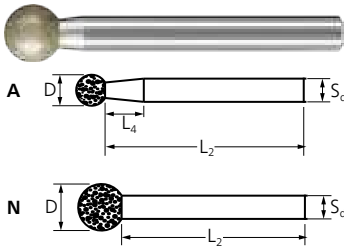

### Ball shape KU

The ball shape KU is often used in manual applications. This shape is well-suited for engraving, contour grinding and deburring tasks.



#### Special features:

- Ideal for work on tungsten carbide.
- No chemical wear thanks to the low working temperatures.
- Longer tool life due to harder diamond grain.

D [mm]	S <sub>d</sub> [mm]	L <sub>2</sub> [mm]	L <sub>4</sub> [mm]	Grit size		Item no.	Designation	Price/unit EUR
<b>Shank diameter 3 mm</b>								
1	3	44	10	D 64	5	36201006	DKU-A 1,0/3 D 64	-
				D 91	5	36201009	DKU-A 1,0/3 D 91	-
				D 126	5	36201010	DKU-A 1,0/3 D 126	-
				D 181	5	36201018	DKU-A 1,0/3 D 181	-
2	3	43	8	D 64	5	36202006	DKU-A 2,0/3 D 64	-
				D 91	5	36202009	DKU-A 2,0/3 D 91	-
				D 126	5	36202010	DKU-A 2,0/3 D 126	-
				D 181	5	36202018	DKU-A 2,0/3 D 181	-
3	3	42	6	D 64	5	36203006	DKU-A 3,0/3 D 64	-
				D 91	5	36203009	DKU-A 3,0/3 D 91	-
				D 126	5	36203010	DKU-A 3,0/3 D 126	-
				D 181	5	36203018	DKU-A 3,0/3 D 181	-
4	3	41	5	D 91	5	36204009	DKU-A 4,0/3 D 91	-
				D 126	5	36204010	DKU-A 4,0/3 D 126	-
				D 181	5	36204018	DKU-A 4,0/3 D 181	-
5	3	40	2	D 91	5	36205009	DKU-A 5,0/3 D 91	-
				D 126	5	36205010	DKU-A 5,0/3 D 126	-
				D 181	5	36205018	DKU-A 5,0/3 D 181	-
6	3	39	-	D 91	1	36206009	DKU-N 6,0/3 D 91	-
				D 126	1	36206010	DKU-N 6,0/3 D 126	-
				D 181	1	36206018	DKU-N 6,0/3 D 181	-
<b>Shank diameter 6 mm</b>								
8	6	52	10	D 126	1	36208010	DKU-A 8,0/6 D 126	-
10	6	50	5	D 126	1	36210010	DKU-A 10,0/6 D 126	-
12	6	48	-	D 126	1	36212010	DKU-N 12,0/6 D 126	-

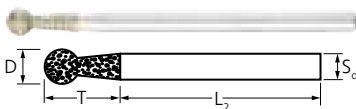

### Special shape KU

Often used for deburring plastic profiles in manual applications. This shape is also coated with abrasive grain under the ball-shaped part of the grinding point on the stepped shank. The special shape provides optimum results when machining profiles.

#### Special features:

- Ideal for work on tungsten carbide.
- No chemical wear thanks to the low working temperatures.
- Longer tool life due to harder diamond grain.

D [mm]	T [mm]	S <sub>d</sub> [mm]	L <sub>2</sub> [mm]	Grit size		Item no.	Designation	Price/unit EUR
<b>Shank diameter 3 mm</b>								
3	10	3	40	D 181	1	36223018	DKU 3,0-10/3 D 181	-
4	10	3	40	D 181	1	36224018	DKU 4,0-10/3 D 181	-



# Diamond and CBN tools – electroplated bond

## Diamond grinding points

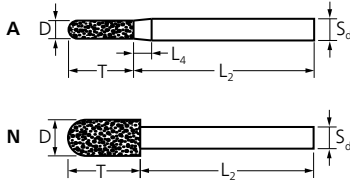

### Cylindrical shape with radius end WR

The cylindrical shape with radius end WR is best suited to manual applications and can be used for a wide variety of deburring and grinding tasks. Coarse grit size D 357 is exceptionally well-suited for use on fibre-reinforced plastics (GRP/CRP).

#### Special features:

- Ideal for work on tungsten carbide.
- No chemical wear thanks to the low working temperatures.
- Longer tool life due to harder diamond grain.

D [mm]	T [mm]	S <sub>d</sub> [mm]	L <sub>2</sub> [mm]	L <sub>4</sub> [mm]	Grit size		Item no.	Designation	Price/unit EUR
<b>Shank diameter 6 mm</b>									
5	18	6	50	5	D 126	1	36425026	DWR-A 5,0-18/6 D 126	-
					D 357	1	36425035	DWR-A 5,0-18/6 D 357	-
6	18	6	50	5	D 126	1	36426026	DWR-A 6,0-18/6 D 126	-
					D 357	1	36426035	DWR-A 6,0-18/6 D 357	-
10	20	6	50	-	D 126	1	36431026	DWR-N 10,0-20/6 D 126	-
					D 357	1	36431057	DWR-N 10,0-20/6 D 357	-

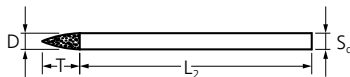

### Pointed tree shape SPG

The pointed tree shape SPG is exceptionally well-suited to machining small holes or bores as well as for engraving work.



#### Special features:

- Ideal for work on tungsten carbide.
- No chemical wear thanks to the low working temperatures.
- Longer tool life due to harder diamond grain.

D [mm]	T [mm]	S <sub>d</sub> [mm]	L <sub>2</sub> [mm]	Grit size		Item no.	Designation	Price/unit EUR
<b>Shank diameter 3 mm</b>								
3	7	3	43	D 126	1	36443010	DSPG 3,0-7/3 D 126	-
	13	3	37	D 126	1	36443020	DSPG 3,0-13/3 D 126	-
<b>Shank diameter 6 mm</b>								
6	18	6	50	D 126	1	36443030	DSPG 6,0-18/6 D 126	-





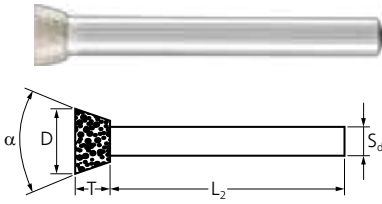

### Cup shape KT

The cup shape KT is ideal for work on profiles, planar surfaces and ledges, without the cylindrical surface being damaged.

#### Special features:

- Ideal for work on tungsten carbide.
- No chemical wear thanks to the low working temperatures.

- Longer tool life due to harder diamond grain.

D [mm]	T [mm]	$\alpha$ [°]	$S_d$ [mm]	$L_2$ [mm]	Grit size		Item no.	Designation	Price/unit EUR
<b>Shank diameter 3 mm</b>									
3	7	8	3	43	D 126	1	36453010	DKT 3,0-8°/3 D 126	-
<b>Shank diameter 6 mm</b>									
10	5	30	6	50	D 126	1	36461010	DKT 10,0-30°/6 D 126	-

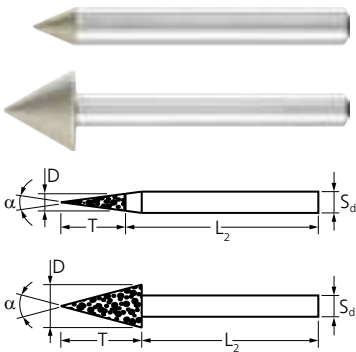

### Conical pointed shape SK

The conical pointed shape SK is exceptionally well-suited to deburring bores, regrinding centring holes and chamfering.



#### Special features:

- Ideal for work on tungsten carbide.
- No chemical wear thanks to the low working temperatures.
- Longer tool life due to harder diamond grain.

D [mm]	T [mm]	$\alpha$ [°]	$S_d$ [mm]	$L_2$ [mm]	Grit size		Item no.	Designation	Price/unit EUR	
<b>Shank diameter 6 mm</b>										
6	45	7	6	50	D 64	1	36476007	DSK 6,0-7°/6 D 64	-	
					D 126	1	36476026	DSK 6,0-7°/6 D 126	-	
	26	12	12	6	50	D 64	1	36476012	DSK 6,0-12°/6 D 64	-
						D 126	1	36476120	DSK 6,0-12°/6 D 126	-
						D 64	1	36476015	DSK 6,0-15°/6 D 64	-
						D 126	1	36476150	DSK 6,0-15°/6 D 126	-
	11	30	30	6	50	D 64	1	36476006	DSK 6,0-30°/6 D 64	-
						D 126	1	36476030	DSK 6,0-30°/6 D 126	-
	5	60	60	6	50	D 64	1	36476060	DSK 6,0-60°/6 D 64	-
						D 126	1	36470126	DSK 6,0-60°/6 D 126	-
	10	9	60	6	50	D 64	1	36476104	DSK 10,0-60°/6 D 64	-
						D 126	1	36476106	DSK 10,0-60°/6 D 126	-
5		90	90	6	50	D 64	1	36476124	DSK 10,0-90°/6 D 64	-
						D 126	1	36476126	DSK 10,0-90°/6 D 126	-
15	13	60	6	50	D 64	1	36476144	DSK 15,0-60°/6 D 64	-	
					D 126	1	36476146	DSK 15,0-60°/6 D 126	-	
	7.5	90	90	6	50	D 64	1	36476164	DSK 15,0-90°/6 D 64	-
					D 126	1	36476166	DSK 15,0-90°/6 D 126	-	



# Diamond and CBN tools – electroplated bond

## Diamond grinding points



### Diamond grinding point set

The set contains 10 diamond grinding points with grit size D 126 in the most common shapes and dimensions. The sturdy plastic box protects the tools from dirt and damage.

#### Contents:

Contains one each of the following diamond grinding points:  
 DZY-A 1.0-4/3 D 126,  
 DZY-A 2.0-4/3 D 126, DZY-N 4.0-5/3 D 126,  
 DZY-N 5.0-5/3 D 126, DZY-N 14.0-1.1/3 D 126,  
 DKU-A 2.0/3 D 126, DKU-A 4.0/3 D 126,  
 DKU-N 6.0/3 D 126, DSPG 3.0-7/3 D 126 and  
 DKT 3.0-8°/3 D 126.

#### Special features:

- Ideal for work on tungsten carbide.
- No chemical wear thanks to the low working temperatures.
- Longer tool life due to harder diamond grain.

$S_d$ [mm]	Grit size		Item no.	Designation	Price/unit EUR
3	D 126	1	36476067	D-Set/3 D126	-

## Diamond grinding discs

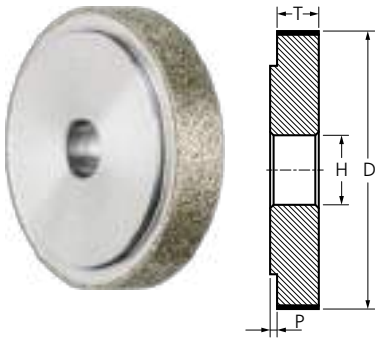

### Grinding discs 1A1

Diamond grinding discs are intended for use on stationary machines. As from an outer diameter of 18 mm: with additional centring shoulder which allows them to be mounted and aligned on the machine spindle. Combined with a stable mandrel, these tools are ideal for work in deep-set or long bores.



#### Special features:

- Ideal for work on tungsten carbide.
- No chemical wear thanks to the low working temperatures.
- Longer tool life due to harder diamond grain.

D [mm]	T [mm]	H [mm]	P [mm]	Grit size		Item no.	Designation	Price/unit EUR
18	10	8	2	D 151	1	36618015	D1A1 18-10-8 D 151	-
20	10	8	2	D 151	1	36622015	D1A1 20-10-8 D 151	-
30	10	10	2	D 151	1	36623015	D1A1 30-10-10 D 151	-
40	10	10	2	D 151	1	36624015	D1A1 40-10-10 D 151	-
50	10	10	2	D 151	1	36625015	D1A1 50-10-10 D 151	-

5



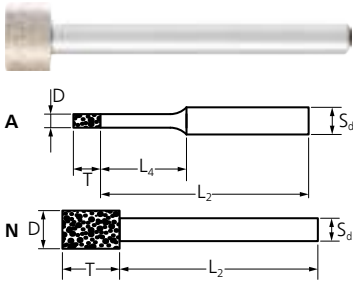

### Cylindrical shape ZY

The cylindrical shape ZY is suitable for grinding bores, radii and contours in stationary or manual applications. Grinding points with a diameter of 8 mm or more have a recess on the front surface.



#### Special features:

- Ideal for work on hardened steel.
- No chemical wear thanks to the low working temperatures.

D [mm]	T [mm]	S <sub>d</sub> [mm]	L <sub>2</sub> [mm]	L <sub>4</sub> [mm]	Grit size		Item no.	Designation	Price/unit EUR
<b>Shank diameter 3 mm</b>									
0.5	2	3	38	5	B 64	5	36100506	BZY-A 0,5-2/3 B 64	-
0.8	2	3	38	5	B 64	5	36100806	BZY-A 0,8-2/3 B 64	-
1	4	3	36	9	B 64	5	36101006	BZY-A 1,0-4/3 B 64	-
					B 126	5	36101010	BZY-A 1,0-4/3 B 126	-
1.2	4	3	36	9	B 64	5	36101206	BZY-A 1,2-4/3 B 64	-
					B 126	5	36101210	BZY-A 1,2-4/3 B 126	-
1.4	4	3	36	9	B 126	5	36101410	BZY-A 1,4-4/3 B 126	-
1.6	4	3	36	10	B 64	5	36101606	BZY-A 1,6-4/3 B 64	-
					B 126	5	36101610	BZY-A 1,6-4/3 B 126	-
1.8	4	3	36	10	B 126	5	36101810	BZY-A 1,8-4/3 B 126	-
2	4	3	36	10	B 64	5	36102006	BZY-A 2,0-4/3 B 64	-
					B 126	5	36102010	BZY-A 2,0-4/3 B 126	-
2.2	4	3	36	14	B 126	5	36102210	BZY-A 2,2-4/3 B 126	-
2.4	4	3	36	14	B 64	5	36102406	BZY-A 2,4-4/3 B 64	-
					B 126	5	36102410	BZY-A 2,4-4/3 B 126	-
2.6	4	3	36	14	B 64	5	36102606	BZY-A 2,6-4/3 B 64	-
					B 126	5	36102610	BZY-A 2,6-4/3 B 126	-
2.8	4	3	36	14	B 126	5	36102810	BZY-A 2,8-4/3 B 126	-
3	4	3	36	19	B 64	5	36103006	BZY-A 3,0-4/3 B 64	-
					B 126	5	36103010	BZY-A 3,0-4/3 B 126	-
3.5	5	3	45	-	B 64	5	36103506	BZY-N 3,5-5/3 B 64	-
					B 126	5	36103510	BZY-N 3,5-5/3 B 126	-
4	5	3	45	-	B 64	5	36104006	BZY-N 4,0-5/3 B 64	-
					B 126	5	36104010	BZY-N 4,0-5/3 B 126	-
4.5	5	3	45	-	B 126	5	36104510	BZY-N 4,5-5/3 B 126	-
5	5	3	45	-	B 64	5	36105006	BZY-N 5,0-5/3 B 64	-
					B 126	5	36105010	BZY-N 5,0-5/3 B 126	-
5.5	6	3	44	-	B 126	5	36105510	BZY-N 5,5-6/3 B 126	-
<b>Shank diameter 6 mm</b>									
6	6	6	54	19	B 126	1	36106010	BZY-A 6,0-6/6 B 126	-
7	8	6	52	-	B 126	1	36107010	BZY-N 7,0-8/6 B 126	-
8	8	6	52	-	B 126	1	36108010	BZY-N 8,0-8/6 B 126	-
9	8	6	52	-	B 126	1	36109010	BZY-N 9,0-8/6 B 126	-
10	8	6	52	-	B 126	1	36110010	BZY-N 10,0-8/6 B 126	-
12	8	6	52	-	B 126	1	36112010	BZY-N 12,0-8/6 B 126	-
13	10	6	50	-	B 126	1	36113010	BZY-N 13,0-10/6 B 126	-
14	10	6	50	-	B 126	1	36114010	BZY-N 14,0-10/6 B 126	-
15	10	6	50	-	B 126	1	36115010	BZY-N 15,0-10/6 B 126	-
18	10	6	50	-	B 126	1	36118010	BZY-N 18,0-10/6 B 126	-

Continued on next page



# Diamond and CBN tools – electroplated bond

## CBN grinding points



D [mm]	T [mm]	S <sub>d</sub> [mm]	L <sub>2</sub> [mm]	L <sub>4</sub> [mm]	Grit size		Item no.	Designation	Price/unit EUR
20	10	6	50	-	B 126	1	36120010	BZY-N 20,0-10/6 B 126	-
<b>Shank diameter 10 mm</b>									
15	10	10	110	-	B 126	1	36115110	BZY-N 15,0-10/10 B 126	-

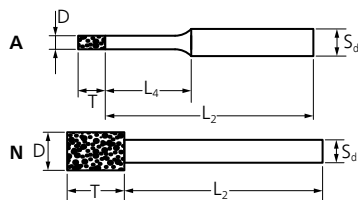

### Cylindrical points with tungsten carbide shank

Cylindrical mounted points with tungsten carbide shanks are used for internal grinding on stationary machines. In internal grinding applications, tools with a tungsten carbide shank offer higher stock removal rates, superior surfaces and more precise shape and position tolerances.

#### Special features:

- Ideal for work on hardened steel.
- No chemical wear thanks to the low working temperatures.

D [mm]	T [mm]	S <sub>d</sub> [mm]	L <sub>2</sub> [mm]	L <sub>4</sub> [mm]	Grit size		Item no.	Designation	Price/unit EUR
<b>Shank diameter 3 mm</b>									
4	5	3	43	-	B 151	1	36154515	BZY-N 4,0-5/3 HM B 151	-
<b>Shank diameter 6 mm</b>									
6	6	6	98	19	B 151	1	36136615	BZY-A 6,0-6/6 HM B 151	-
8	8	6	98	-	B 151	1	36158815	BZY-N 8,0-8/6 HM B 151	-
12	8	6	98	-	B 151	1	36161151	BZY-N 12,0-8/6 HM B 151	-

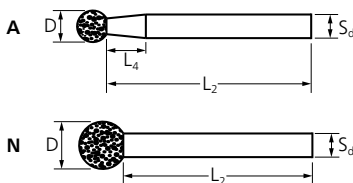

### Ball shape KU

Spherical shape CBN grinding points are often used for engraving, contours and deburring work.

#### Special features:

- Ideal for work on hardened steel.
- No chemical wear thanks to the low working temperatures.

D [mm]	S <sub>d</sub> [mm]	L <sub>2</sub> [mm]	L <sub>4</sub> [mm]	Grit size		Item no.	Designation	Price/unit EUR
<b>Shank diameter 3 mm</b>								
1	3	44	10	B 64	5	36301006	BKU-A 1,0/3 B 64	-
				B 126	5	36301010	BKU-A 1,0/3 B 126	-
2	3	43	8	B 126	5	36302010	BKU-A 2,0/3 B 126	-
3	3	42	6	B 64	5	36303006	BKU-A 3,0/3 B 64	-
				B 126	5	36303010	BKU-A 3,0/3 B 126	-
4	3	41	5	B 126	5	36304010	BKU-A 4,0/3 B 126	-
5	3	40	2	B 126	5	36305010	BKU-A 5,0/3 B 126	-
6	3	39	-	B 126	1	36306010	BKU-N 6,0/3 B 126	-
<b>Shank diameter 6 mm</b>								
8	6	52	10	B 126	1	36308010	BKU-A 8,0/6 B 126	-
10	6	50	5	B 126	1	36310010	BKU-A 10,0/6 B 126	-
12	6	48	-	B 126	1	36312010	BKU-N 12,0/6 B 126	-

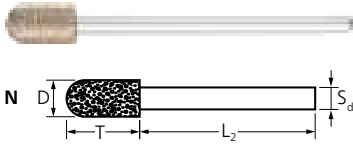

### Cylindrical shape with radius end WR

The cylindrical shape with radius end WR is best suited to manual applications and can be used for a wide variety of deburring and grinding tasks.

**Special features:**

- Ideal for work on hardened steel.
- No chemical wear thanks to the low working temperatures.

D [mm]	T [mm]	S <sub>d</sub> [mm]	L <sub>2</sub> [mm]	Grit size		Item no.	Designation	Price/unit EUR
<b>Shank diameter 3 mm</b>								
5	10	3	40	B 126	1	36525010	BWR-N 5,0-10/3 B 126	-
6	10	3	40	B 126	1	36526010	BWR-N 6,0-10/3 B 126	-

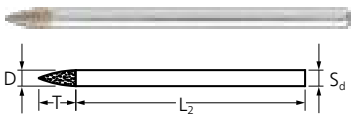

### Pointed tree shape SPG

The pointed tree shape SPG is exceptionally well-suited to machining small holes or bores as well as for engraving work.

**Special features:**

- Ideal for work on hardened steel.
- No chemical wear thanks to the low working temperatures.

D [mm]	T [mm]	S <sub>d</sub> [mm]	L <sub>2</sub> [mm]	Grit size		Item no.	Designation	Price/unit EUR
<b>Shank diameter 3 mm</b>								
3	7	3	43	B 126	1	36543010	BSPG 3,0-7/3 B 126	-
<b>Shank diameter 6 mm</b>								
6	18	6	50	B 126	1	36546010	BSPG 6,0-18/6 B 126	-

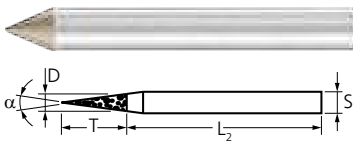

### Conical pointed shape SK

The conical pointed shape SK is exceptionally well-suited to deburring bores, regrinding centring holes and chamfering.

**Special features:**

- Ideal for work on hardened steel.
- No chemical wear thanks to the low working temperatures.

D [mm]	T [mm]	α [°]	S <sub>d</sub> [mm]	L <sub>2</sub> [mm]	Grit size		Item no.	Designation	Price/unit EUR
<b>Shank diameter 6 mm</b>									
6	7	45	6	50	B 64	1	36576045	BSK 6,0-45°/6 B 64	-
	5	60	6	50	B 64	1	36576060	BSK 6,0-60°/6 B 64	-



# Diamond and CBN tools – electroplated bond

## CBN grinding discs

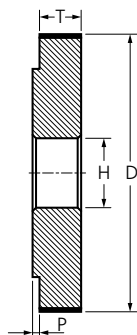

### Grinding discs 1A1

CBN grinding discs are intended for use on stationary machines. They have an additional centring shoulder which allows them to be accurately mounted and aligned on the machine spindle. Combined with a stable mandrel, these tools are ideal for work in deep-set or long bores.



#### Special features:

- Ideal for work on hardened steel.
- No chemical wear thanks to the low working temperatures.

D [mm]	T [mm]	H [mm]	P [mm]	Grit size		Item no.	Designation	Price/unit EUR
20	10	8	2	B 151	1	36722015	B1A1 20-10-8 B 151	-
30	10	10	2	B 151	1	36723015	B1A1 30-10-10 B 151	-
40	10	10	2	B 151	1	36724015	B1A1 40-10-10 B 151	-
50	10	10	2	B 151	1	36725015	B1A1 50-10-10 B 151	-





### Shape D (continuous coating)

The continuous coating is particularly suitable for very fine separating cuts.



### Shape G (with protective segments)

The continuous coating with protective segments facilitates optimum free-cutting.



### Shape S 2 (segmented)

The segmentation allows particularly good chip removal.



### Diamond cut-off wheels

Electroplated diamond cut-off wheels are used with grit sizes from D 64 to D 427 for cutting hard materials such as tungsten carbide or ceramics and fibre-reinforced plastics (GRP/CRP).



#### Special features:

- Ideal for work on hardened steel.
- No chemical wear thanks to the low working temperatures.
- Longer tool life due to harder diamond grain.

D [mm]	T [mm]	E [mm]	H [mm]	Shape	Protective seg. per side	Grit size		Item no.	Designation	Price/unit EUR
<b>Hard materials, e.g. glass, ceramic or tungsten carbide</b>										
22	0.5	0.3	1.7	D	no	D 64	1	68402206	D1A1R 22-0,5-1,7 D 64 GAD	-
30	1	0.6	10	D	no	D 151	1	68403015	D1A1R 30-1-10 D 151 GAD	-
40	1	0.6	10	D	no	D 151	1	68404015	D1A1R 40-1-10 D 151 GAD	-
50	1.4	1	10	D	no	D 151	1	68405025	D1A1R 50-1,4-10 D 151 GAD	-
			6	D	no	D 151	1	68405015	D1A1R 50-1,4-6 D 151 GAD	-
125	1.4	1	20	D	no	D 151	1	68412115	D1A1R 125-1,4-20 D 151 GAD	-
<b>Fibre-reinforced plastics (GRP and CRP) as well as pre-sintered and green ceramic</b>										
50	2	1	10	D	no	D 357	1	68405164	D1A1R 50-2-10 D 357 GAD	-
				G	3	D 357	1	68405163	D1A1R 50-2-10 D 357 GAG	-
			6	D	no	D 357	1	68405064	D1A1R 50-2-6 D 357 GAD	-
				G	3	D 357	1	68405063	D1A1R 50-2-6 D 357 GAG	-
75	2	1	10	D	no	D 357	1	68407503	D1A1R 75-2-10 D 357 GAD	-
				G	3	D 357	1	68407103	D1A1R 75-2-10 D 357 GAG	-
100	2	1	22.23	D	no	D 427	1	68410237	D1A1R 100-2-22,23 D 427 GAD	-
				G	3	D 427	1	68410238	D1A1R 100-2-22,23 D 427 GAG	-
115	2	1	22.23	D	no	D 427	1	68411237	D1A1R 115-2-22,23 D 427 GAD	-
				G	3	D 427	1	68411238	D1A1R 115-2-22,23 D 427 GAG	-
125	2	1	22.23	D	no	D 427	1	68412237	D1A1R 125-2-22,23 D 427 GAD	-
				G	3	D 427	1	68412238	D1A1R 125-2-22,23 D 427 GAG	-
178	2	1	22.23	D	no	D 427	1	68417838	D1A1R 178-2-22,23 D 427 GAD	-
230	2.5	1.5	22.23	S2	no	D 427	1	68423227	D1A1RSS 230-2,5-22,23 D 427 GAS2	-
250	2.5	1.5	22.23	S2	no	D 427	1	68425037	D1A1RSS 250-2,5-22,23 D 427 GAS2	-
300	2.5	1.5	30	S2	no	D 427	1	68430037	D1A1RSS 300-2,5-30,0 D 427 GAS2	-
350	2.8	1.8	30	S2	no	D 427	1	68435037	D1A1RSS 350-2,8-30,0 D 427 GAS2	-
400	3.8	2.8	30	S2	no	D 427	1	68440137	D1A1RSS 400-3,8-30,0 D 427 GAS2	-



# Diamond and CBN tools – electroplated bond

## Diamond cut-off wheels

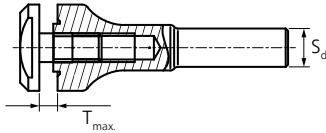

### Arbor for diamond cut-off wheels

Accessory for mounting diamond cut-off wheels up to and including a diameter of 75 mm.

$S_d$ [mm]	Suitable for hole diameter [mm]	$T_{max}$ [mm]	Max. RPM [mm]		Item no.	Designation	Price/unit EUR
3	1.7	1	28,000	1	68400317	BO 3/1,7 1	-
6	10	3	30,000	1	33512040	BO 6/10 3	-
8	10	3	30,000	1	33513900	BO 8/10 3	-

## Diamond cut-off wheels and grinding points for foundries

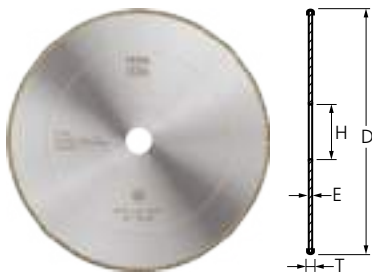

### Diamond cut-off wheels for grey and nodular cast iron

Electroplated diamond cut-off wheels with grit size D 852 are exceptionally well-suited to machining grey cast iron and nodular cast iron (GG and GGG or GJL and GJS) as well as for use in robots. They have a very long tool life.



#### Special features:

- Ideal for work on deep areas because of the constant tool diameter.
- Easy and quick elimination of metal contamination.
- Minimized dust formation due to the monolayer coating and coarse chips.

D [mm]	T [mm]	E [mm]	H [mm]	Shape	Protective seg. per side	Grit size		Item no.	Designation	Price/ unit EUR
<b>Grey and nodular cast iron (GG and GGG or GJL and GJS)</b>										
230	3.8	1.8	22.23	D	no	D 852	1	68423228	D1A1R 230-3,8-22,23 D 852 GAD	-
400	4.5	2.5	40	D	no	D 852	1	68440037	D1A1R 400-4,5-40,0 D 852 GAD	-





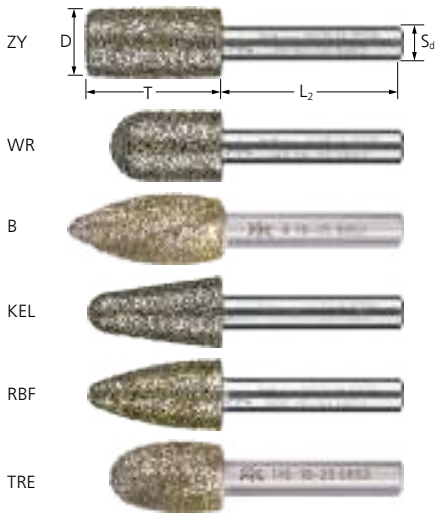

### Diamond grinding points for grey and nodular cast iron

Diamond grinding points with grit size D 852 are exceptionally well-suited to machining grey cast iron and nodular cast iron (GG and GGG or GJL and GJS). They have an outstanding tool life.



#### Special features:

- Fast, aggressive grinding with maximum stock removal rate.
- Easy and quick elimination of metal contamination thanks to diamond as a super-hard abrasive.
- Lower dust load due to the dimensional stability of the grinding tool (no tool wear).

D [mm]	T [mm]	S <sub>d</sub> [mm]	L <sub>2</sub> [mm]	Grit size		Item no.	Designation	Price/unit EUR
<b>Cylindrical shape ZY</b>								
16	30	8	40	D 852	1	36015019	DZY-N 16-30/8 D 852	-
20	30	8	40	D 852	1	36015020	DZY-N 20-30/8 D 852	-
24	30	8	40	D 852	1	36015022	DZY-N 24-30/8 D 852	-
45	6.5	8	40	D 852	1	36803965	DZY-N 45-6,5/8 D 852	-
<b>Cylindrical shape with radius end WR</b>								
10	20	6	40	D 852	1	36476061	DWR-N 10-20/6 D 852	-
12	25	6	40	D 852	1	36476062	DWR-N 12-25/6 D 852	-
16	25	8	40	D 852	1	36476063	DWR-N 16-25/8 D 852	-
20	30	8	40	D 852	1	36476068	DWR-N 20-30/8 D 852	-
24	30	8	40	D 852	1	36476069	DWR-N 24-30/8 D 852	-
<b>Flame-shaped B</b>								
16	35	8	40	D 852	1	36803966	DB-N 16-35/8 D 852	-
<b>Conical shape KEL</b>								
12	25	6	40	D 852	1	36476071	DKEL-N 12-25/6 D 852	-
16	30	8	40	D 852	1	36476064	DKEL-N 16-30/8 D 852	-
20	30	8	40	D 852	1	36476070	DKEL-N 20-30/8 D 852	-
24	30	8	40	D 852	1	36476072	DKEL-N 24-30/8 D 852	-
<b>Tree shape with radius end RBF</b>								
12	25	6	40	D 852	1	36476065	DRBF-N 12-25/6 D 852	-
16	30	8	40	D 852	1	36476066	DRBF-N 16-30/8 D 852	-
20	30	8	40	D 852	1	36476073	DRBF-N 20-30/8 D 852	-
<b>Oval shape TRE</b>								
16	25	8	40	D 852	1	36803967	DTRE-N 16-25/8 D852	-



# Diamond and CBN tools – electroplated bond

## Diamond grinding discs CC-GRIND SOLID DIAMOND

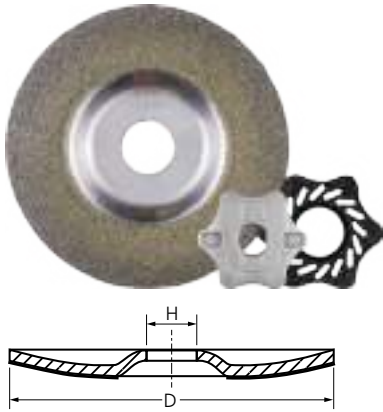

### CC-GRIND SOLID DIAMOND

The CC-GRIND SOLID DIAMOND has been specially developed for applications on hard materials which cannot be machined with conventional tools made of aluminium oxide or silicon carbide.



#### Special features:

- Fast, aggressive grinding with maximum stock removal rate.
- Easy and quick elimination of metal contamination thanks to diamond as a super-hard abrasive.
- Lower dust load due to the dimensional stability of the grinding tool (no tool wear).

D [mm]	H [mm]	Grit size	Max. RPM		Item no.	Designation	Price/unit EUR
<b>Integrated clamping flange set SFS CC-GRIND SOLID 100 M10</b>							
100	16	D 427	15,300	1	36610042	CC-GRIND SOLID DIAMOND 100-16.0 D 427	-
		D 852	15,300	1	36610085	CC-GRIND SOLID DIAMOND 100-16.0 D 852	-
<b>Integrated clamping flange set SFS CC-GRIND SOLID/FLEX 115/125 M14</b>							
115	22.23	D 427	13,300	1	36611542	CC-GRIND SOLID DIAMOND 115-22.23 D 427	-
		D 852	13,300	1	36611585	CC-GRIND SOLID DIAMOND 115-22.23 D 852	-
125	22.23	D 427	12,200	1	36612542	CC-GRIND SOLID DIAMOND 125-22.23 D 427	-
		D 852	12,200	1	36612585	CC-GRIND SOLID DIAMOND 125-22.23 D 852	-

5

## Diamond sabre saw blades



### Diamond sabre saw blades

Diamond sabre saw blades are suitable for work on fibre-reinforced plastics (GRP/CRP). Flexible cutting line for producing a wide range of geometries, plus a long tool life. Suitable for cutting out holes and for cutting.

Total length [mm]	Total width [mm]	Coating length [mm]	Grit size		Item no.	Designation	Price/unit EUR
75	2	50	D 357	1	15600571	DIA-SSB 50/75 D 357	-
100	2	75	D 357	1	15600791	DIA-SSB 75/100 D 357	-

In addition to the standard resinoid-bonded diamond and CBN grinding tools available from stock, customer-specific tool solutions are also possible. In your request, please specify the material to be worked, the application and the tool drive.

In the following tables, all the available shapes and dimensions are shown. For dimensions separated by slashes, please select the desired dimension.

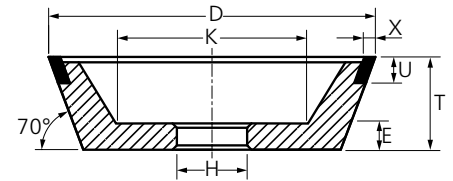

## Explanation of the abbreviations

- $\alpha$  = Mount angle
- D [mm] = Outer diameter
- E [mm] = Bottom thickness
- H [mm] = Bore diameter
- J [mm] = Smaller diameter
- K [mm] = Internal diameter
- L<sub>2</sub> [mm] = Shank length
- L<sub>4</sub> [mm] = Reduced diameter length
- R [mm] = Radius
- S<sub>1</sub> [mm] = Reduced diameter
- S<sub>d</sub> [mm] = Shank diameter
- T [mm] = Total width
- U [mm] = Coating width
- W [mm] = Mounted point width
- X [mm] = Usable abrasive coating thickness



# Diamond and CBN tools – resinoid bond

## Customer-specific tool solutions



### Shape 1A1

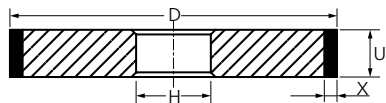

D [mm]	U [mm]	X [mm]	H [mm]
50	4 / 6 / 8 / 10 / 12	3 / 4 / 5 / 6	Please specify
75	6 / 8 / 10 / 12	3 / 4 / 5 / 6	
100	6 / 8 / 10 / 12	3 / 4 / 5 / 6	
125	8 / 10 / 12 / 15	3 / 4 / 5 / 6	
150	8 / 10 / 12 / 15 / 20	3 / 4 / 5 / 6	
175	10 / 12 / 15 / 20	3 / 4 / 5	
200	12 / 15 / 20 / 25 / 30	3 / 4 / 5 / 6	
225	12 / 15 / 20	3 / 4 / 5	
250	15 / 20 / 25 / 30 / 40 / 50	3 / 4 / 5	
300	15 / 20 / 25 / 30 / 40 / 50	3 / 4 / 5 / 6	
350	20 / 25 / 30 / 40 / 50	3 / 4 / 5 / 6	
400	25 / 30 / 40 / 50	3 / 4 / 5 / 6	
450	25 / 30 / 40 / 50	3 / 4 / 5 / 6	
500	30 / 40 / 50	3 / 4 / 5 / 6	
600	35 / 40	3 / 5	

Ordering example: 1A1 200-20-4-127 D 126 PHN C 75

### Shape 1FF1

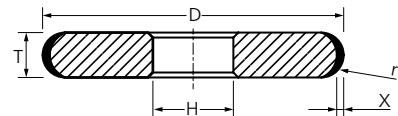

D [mm]	T [mm]	X [mm]	R [mm]	H [mm]
50	6	2	3	Please specify
	8		4	
	10		5	
75	6		3	
	8		4	
	10		5	
100	6		3	
	8		4	
	10		5	
	12		6	
125	6		3	
	8		4	
	10	5		
	12	6		
150	6	3		
	8	4		
	10	5		
	12	6		

Ordering example: 1FF1 150-8/4R-2-32 D 126 PHN C 75

5

### Shape 4A2

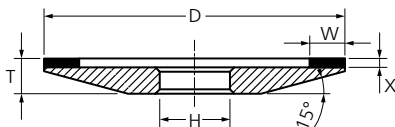

D [mm]	W [mm]	X [mm]	H [mm]	T - X [mm]
50	3 / 5	2 / 3 / 4	Please specify	5
75				5
100	3 / 4 / 5 / 6 / 8 / 10			6
125	3 / 4 / 5 / 6 / 8 / 10			7
150	3 / 4 / 5 / 6 / 8 / 10 / 12.5			9

Ordering example: 4A2 100-4-2-20 D 64 PHT C 50

### Shape 4BT9

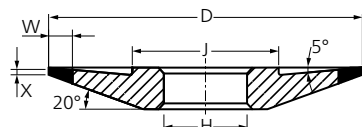

D [mm]	W [mm]	X [mm]	H [mm]	T [mm]	J [mm]
75	6	1	Please specify	8	36
100				10	50
125				12	65
150				15	80

Ordering example: 4BT9 100-6-1-20 D 126 PHN C 75

Other dimensions on request!

## Shape 1A1W

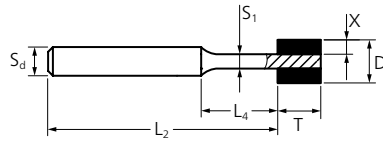

D [mm]	T [mm]	X [mm]	S <sub>d</sub> [mm]	L <sub>2</sub> [mm]	S <sub>1</sub> [mm]	L <sub>4</sub> [mm]
3	6	0.75	3	60	1.5	8
4	6	1	3	60	2	8
5	6	1.5	3	60	2	8
6	6	1.5	6	60	3	8
6	8	1.5	6	60	3	10
7	6	2	6	60	3	8
8	6	2	6	60	4	8
8	10	2	6	60	4	12
9	6	2	6	60	5	8

Ordering example: 1A1W 8-6-2-6-60-4-8 D 91 PHNT C 100

## Shape 1A1W

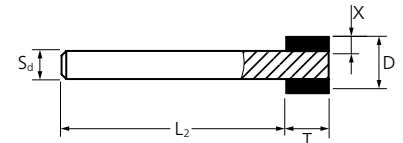

D [mm]	T [mm]	X [mm]	S <sub>d</sub> [mm]	L <sub>2</sub> [mm]
10	6	2	6	60
	10	2	6	60
12	6	2	6	60
	10	2	6	60
15	6	2	6	60
	10	2	6	60
18	6	2	6	60
	10	2	6	60
20	6	2	6	60
	10	2	6	60

Ordering example: 1A1W 15-10-2-6-60 D 91 PHNT C 100

## Shape 1A1R

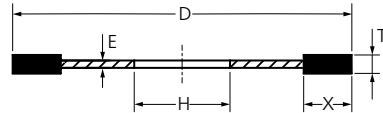

D [mm]	T [mm]	X [mm]	H [mm]	E [mm]
75	1	5	H ≥ 20 mm	0.8
100	1	5	Please specify	0.8
125	1	5		0.8
150	1	7		0.8
175	1.2	7		0.9
200	1.2	7		0.9

Ordering example: 1A1R 150-1-7-20 D 151 PHT C 75

## Shape 6A2

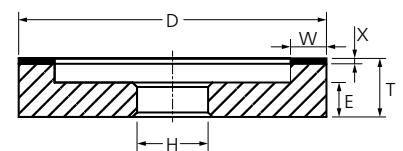

D [mm]	W [mm]	X [mm]	H [mm]	T - X [mm]	E [mm]
50	3 / 5	2 / 3 / 4	Please specify	20	10
75	3 / 5 / 10			20	10
100	5 / 8 / 10 / 12.5 / 15	20		10	
125	4 / 6 / 8 / 10 / 12.5 / 15 / 20 / 25	23		10	
150	6 / 8 / 10 / 12.5 / 15 / 20 / 25	23		10	

Ordering example: 6A2 125-10-2-20 D 126 PHT C 50

## Shape 1V1

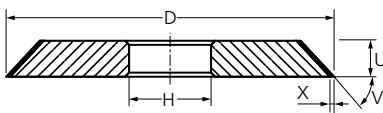

D [mm]	U [mm]	X [mm]	V	H [mm]
50	6 / 8	3 / 4	20° to 89°	Please specify
75	6 / 8 / 10			
100	8 / 10	Please specify		
125	8 / 10			
150	8 / 10			
175	10			
200	12 / 15			
250	15 / 20			
300	15 / 20			

Ordering example: 1V1 150-8-3/60°-32 B 126 PHN C 75

## Shape 6A9

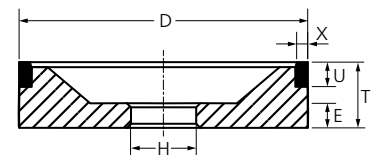

D [mm]	X [mm]	U [mm]	H [mm]	T [mm]	E [mm]
75	1.5	6 / 10	Please specify	25	10
	2	6 / 10		25	10
	3	6 / 10		25	10
100	1.5	6 / 10		30	10
	2	6 / 10		30	10
	3	6 / 10		30	10
125	1.5	6 / 10		30	10
	2	6 / 10		30	10
	3	6 / 10		30	10
150	1.5	6 / 10		35	10
	2	6 / 10		35	10
	3	6 / 10		35	10

Ordering example: 6A9 100-2-10-20 D 126 PHN C 100

Other dimensions on request!



## Shape 9A3

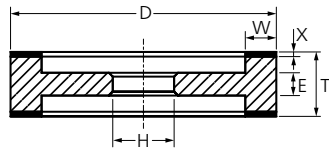

D [mm]	W [mm]	X [mm]	T [mm]	H [mm]	E [mm]
100	6 / 8 / 10	2 / 3	22	Please specify	10
125	6 / 8 / 10		22		10
150	4 / 6 / 8 / 10 / 15		25 / 35		14
			25 / 35		14
200	8 / 10 / 15		30		18

Ordering example: 9A3 150-8-2-25-20 D 64 PHN C 75

## Shape 12A2/20°

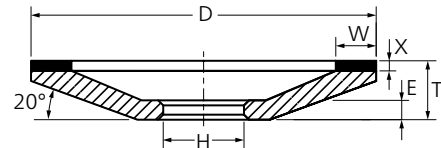

D [mm]	W [mm]	X [mm]	H [mm]	T - X [mm]	E [mm]
75	3 / 5 / 6 / 8 / 10	2 / 3 / 4	Please specify	8	5
100	3 / 5 / 6 / 8 / 10			10	6
125	5 / 6 / 8 / 10			14	8
150	5 / 6 / 8 / 10			16	9
175	6 / 10			18	10
200	6 / 10			20	11
250	6 / 10			23	13

Ordering example: 12A2/20° 125-10-2-20 D 126 PHT C 50

## Shape 11A2

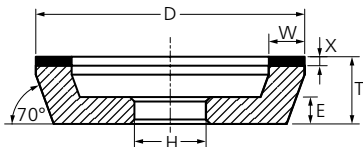

D [mm]	W [mm]	X [mm]	H [mm]	T - X [mm]	E [mm]
50	3 / 6	2 / 3 / 4	Please specify	20	8
75	3 / 6 / 10			20	10
100	4 / 6 / 8 / 10			20	10
125	5 / 6 / 8 / 10 / 12.5 / 15			23	10
150	6 / 8 / 10 / 12.5 / 15			23	10
175	6 / 10 / 12.5 / 15			25	12

Ordering example: 11A2 125-10-2-20 D 126 PHT C 50

## Shape 12A2/45°

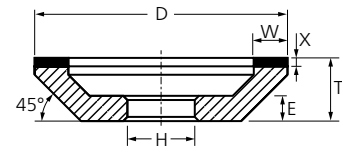

D [mm]	W [mm]	X [mm]	H [mm]	T - X [mm]	E [mm]
50	3 / 6	2 / 3 / 4	Please specify	15	8
75	3 / 6 / 10			20	9
100	4 / 6 / 8 / 10			23	10
125	5 / 6 / 8 / 10 / 12.5 / 15			23	10
150	6 / 8 / 10 / 12.5 / 15			23	10
175	6 / 10 / 12.5 / 15			25	12

Ordering example: 12A2/45° 125-10-2-20 D 126 PHT C 50

## Shape 11V9

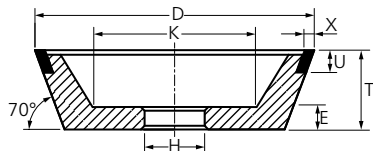

D [mm]	X [mm]	U [mm]	H [mm]	T [mm]	E [mm]	K [mm]
50	2	10	Please specify	30	10	22
75	1.5 / 2 / 3	10		30	10	41
100	1.5 / 2 / 3	10		35	10	60
125	1.5 / 2 / 3	10		40	10	75
150	1.5 / 2 / 3	10		50	10	89

Ordering example: 11V9 100-2-10-20 D 126 PHT C 75

## Shape 12C9

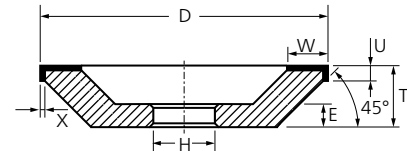

D [mm]	W [mm]	U [mm]	X [mm]	H [mm]	T [mm]	E [mm]
100	6 / 10	4	2	Please specify	26	10
	10	4	3		27	10
125	6 / 10	4	2		26	10
	10	4	3		27	10
	12.5	5	2		26	10
150	10	4	2		26	10
	10	4	3		27	10
	12.5 / 15	5	2		26	10

Ordering example: 12C9 100-10-4-2-20 D 64 PHN C 75

## Shape 12V9

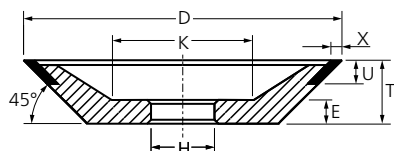

D [mm]	X [mm]	U [mm]	H [mm]	T [mm]	E [mm]	K [mm]
50	2	6	Please specify	20	10	24
75	2 / 3	10		20	10	41
100	1.5 / 2 / 3	10		20	10	62
125	1.5 / 2 / 3	10		25	10	76
150	2 / 3	10		25	10	97

Ordering example: 12V9 100-2-10-20 D 126 PHT C 75

Other dimensions on request!

## Shape 14A1

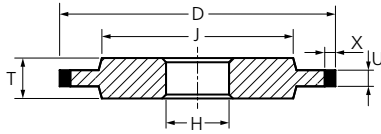

## Shape 3A1

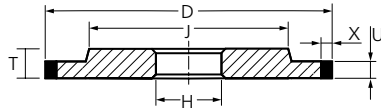

## Shape 14F1

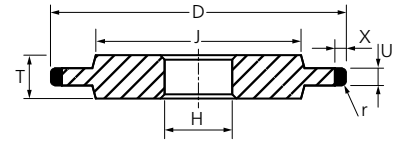

D [mm]	U [mm]	X [mm]	H [mm]	T [mm]	J [mm]
75	1 / 2	3 / 6	Please specify	6	50
	3 / 4 / 5	3 / 4 / 6		6	50
100	1 / 2	3 / 6	Please specify	6	80
	3 / 4 / 5	3 / 4 / 6		6	70
125	1 / 2	3 / 6	Please specify	7	105
	3 / 4 / 5 / 6	3 / 4 / 6		7	100
150	1 / 2	3 / 6	Please specify	8	130
	3 / 4 / 5 / 6	3 / 4 / 6		8	120
175	1 / 2	3 / 6	Please specify	10	150
	3 / 4 / 5 / 6 / 8	3 / 4 / 6		10	140
200	1 / 2	6	Please specify	12	175
	3 / 4 / 5 / 6 / 8 / 10	3 / 4 / 5 / 6		12	160
225	6 / 8 / 10	3 / 4 / 5	12	180	180
250	6 / 8 / 10 / 12	3 / 4 / 5	15	200	200
300	8 / 10 / 12	3 / 4 / 5 / 6	15	250	250
350	10 / 12 / 15	3 / 4 / 5 / 6	20	300	300
400	10 / 12 / 15 / 20	3 / 4 / 5 / 6	25	350	350
450	10 / 12 / 15 / 20	3 / 4 / 5 / 6	25	400	400
500	15 / 20 / 25	3 / 4 / 5 / 6	30	450	450
600	15 / 20 / 25 / 30	3 / 5	35	550	550

Ordering example: 14A1 150-6-3-32 D 107 PHN C 100

D [mm]	U [mm]	X [mm]	R [mm]	H [mm]	T [mm]	J [mm]
40	2	3 / 4 / 5 / 6	1	Please specify	6	25
	3		1.5		6	25
	4		2		6	25
50	2	3 / 4 / 5 / 6	1	Please specify	6	30
	3		1.5		6	30
	4		2		6	30
75	2	3 / 4 / 5 / 6	1	Please specify	6	50
	3		1.5		6	50
	4		2		6	50
100	2	3 / 4 / 5 / 6	1	Please specify	6	70
	3		1.5		6	70
	4		2		6	70
125	2	3 / 4 / 5 / 6	1	Please specify	8	100
	3		1.5		8	100
	4		2		8	100
150	2	3 / 4 / 5 / 6	1	Please specify	8	120
	3		1.5		8	120
	4		2		8	120

Ordering example: 14F1 150-2/1R-6-32 D 107 PHN C 125

## Shape 14V1

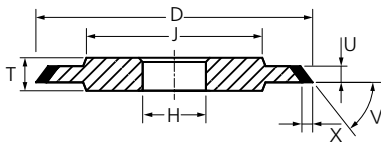

D [mm]	U [mm]	X [mm]	V	C [mm]	T [mm]	J [mm]
50	3 / 4 / 5	2 / 3 / 4	20° to 89°	Please specify	6	30
75	3 / 4 / 5				6	45
100	4 / 6	Please specify	Please specify	Please specify	8	70
125	4 / 6				8	100
150	4 / 6	Please specify	Please specify	Please specify	8	120
175	4 / 6 / 8				10	140
200	4 / 6 / 8 / 10	Please specify	Please specify	Please specify	12	160
250	4 / 6 / 8 / 10 / 12				15	200
300	4 / 6 / 8 / 10 / 12	Please specify	Please specify	Please specify	15	250

Ordering example: 14V1 150-6-3/60°-32 B 126 PHN C 75

## Shape 14E9

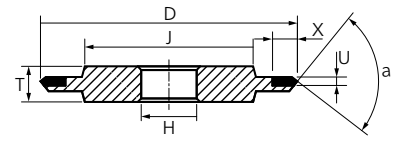

D [mm]	U [mm]	X [mm]	alpha	H [mm]	T [mm]	J [mm]
50	1 / 2	6	35° / 45° / 60° / 90°	Please specify	6	32
75	1 / 2				6	50
100	1 / 2	6	35° / 45° / 60° / 90°	Please specify	6	70
125	1 / 2				6	100
150	1 / 2	6	35° / 45° / 60° / 90°	Please specify	8	100
150	1 / 2				8	120

Ordering example: 14E9 150-2-6-60°-32 D 107 PHN C 125

Other dimensions on request!



# Diamond and CBN tools – resinoid bond

## Diamond grinding tools

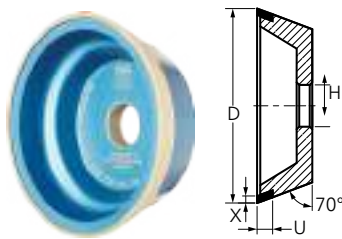

### Shape 11V9

Phenolic resin bond for dry grinding. The PHT bond allows cool grinding, even without coolant. The PHST bond can withstand higher loads, i.e. it allows a higher infeed per stroke, but has a slightly shorter grinding time and tool life.

#### Special features:

- The characteristics of the resinoid bond can be optimally adjusted to the application.

- Easy to dress.

Shape	D [mm]	X [mm]	U [mm]	H [mm]	Bond	Grit size		Item no.	Designation	Price/unit EUR
11V9	100	2	10	20	PHT	D 126	1	68611021	11V9 100-2-10-20 D 126 PHT C75	-
		3	10	20	PHST	D 126	1	68611032	11V9 100-3-10-20 D 126 PHST C75	-

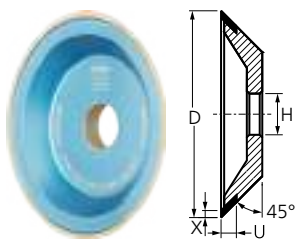

### Shape 12V9

Phenolic resin bond for high-performance dry grinding. The PHT bond is designed for dry grinding and allows cool grinding, even without coolant.

#### Special features:

- The characteristics of the resinoid bond can be optimally adjusted to the application.
- Easy to dress.



Shape	D [mm]	X [mm]	U [mm]	H [mm]	Bond	Grit size		Item no.	Designation	Price/unit EUR
12V9	100	2	10	20	PHT	D 126	1	68612021	12V9 100-2-10-20 D 126 PHT C75	-

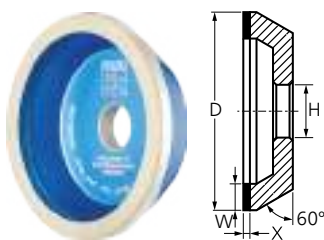

### Shape 11A2/60°

Phenolic resin bond for high-performance dry grinding. The PHT bond is designed for dry grinding and allows cool grinding, even without coolant.

#### Special features:

- The characteristics of the resinoid bond can be optimally adjusted to the application.
- Easy to dress.

Shape	D [mm]	W [mm]	X [mm]	H [mm]	Bond	Grit size		Item no.	Designation	Price/unit EUR
11A2/60°	100	8	2	20	PHT	D 126	1	68613081	11A2/60° 100-8-2-20 D 126 PHT C75	-
						D 64	1	68613086	11A2/60° 100-8-2-20 D 64 PHT C75	-



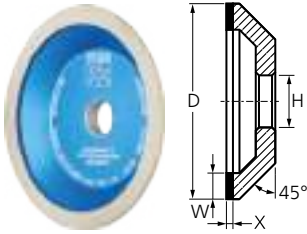

### Shape 12A2/45°

Phenolic resin bond for high-performance dry grinding. The PHT bond is designed for dry grinding and allows cool grinding, even without coolant.

**Special features:**

- The characteristics of the resinoid bond can be optimally adjusted to the application.
- Easy to dress.

Shape	D [mm]	W [mm]	X [mm]	H [mm]	Bond	Grit size		Item no.	Designation	Price/unit EUR
12A2/45°	125	10	2	20	PHT	D 126	1	68612101	12A2/45° 125-10-2-20 D 126 PHT C75	-
						D 64	1	68612106	12A2/45° 125-10-2-20 D 64 PHT C50	-

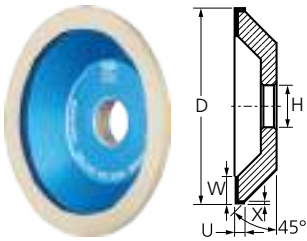

### Shape 12C9

Phenolic resin bond for high-performance dry grinding. The PHT bond is designed for dry grinding and allows cool grinding, even without coolant.

**Special features:**

- The characteristics of the resinoid bond can be optimally adjusted to the application.
- Easy to dress.

Shape	D [mm]	W [mm]	X [mm]	U [mm]	H [mm]	Bond	Grit size		Item no.	Designation	Price/unit EUR
12C9	100	10	3	4	20	PHT	D 126	1	68612023	12C9 100-10-4-3-20 D 126 PHT C75	-

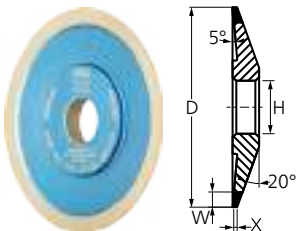

### Shape 4BT9

Phenolic resin bond for high-performance dry grinding. The PHT bond is designed for dry grinding and allows cool grinding, even without coolant.

**Special features:**

- The characteristics of the resinoid bond can be optimally adjusted to the application.

- Easy to dress.

Shape	D [mm]	W [mm]	X [mm]	H [mm]	Bond	Grit size		Item no.	Designation	Price/unit EUR
4BT9	100	6	1	20	PHT	D 126	1	68615101	4BT9 100-6-1-20 D 126 PHT C75	-



### Shape 1A1R

Phenolic resin bond for high-performance dry grinding. The PHT bond is designed for dry grinding and allows cool grinding, even without coolant.

**Special features:**

- The characteristics of the resinoid bond can be optimally adjusted to the application.

- Easy to dress.

Shape	D [mm]	T [mm]	X [mm]	H [mm]	Bond	Grit size		Item no.	Designation	Price/unit EUR
1A1R	100	1	5	20	PHT	D 151	1	68620102	1A1R 100-1-5-20 D 151 PHT C75	-
	150	1	7	20	PHT	D 151	1	68620152	1A1R 150-1-7-20 D 151 PHT C75	-

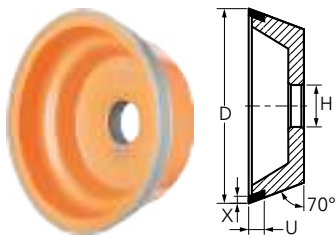

### Shape 11V9

PH 4.1 is a phenolic resin bond for maximum stock removal rates. Very long tool life and suitable for dry and wet grinding. PH 4.2 is a high-performance bond for cool dry grinding at low infeed rates. Only for 11V9 and 12V9 up to dia. 150 mm.

**Special features:**

- The characteristics of the resinoid bond can be optimally adjusted to the application.
- Easy to dress.

Shape	D [mm]	X [mm]	U [mm]	H [mm]	Bond	Grit size		Item no.	Designation	Price/unit EUR
11V9	100	2	10	20	PH 4.1	B 126	1	68664101	11V9 100-2-10-20 B 126 PH 4.1 C75	-
					PH 4.2	B 151	1	68661032	11V9 100-2-10-20 B 151 PH 4.2	-

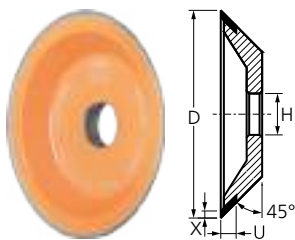

### Shape 12V9

Phenolic resin bond for high-performance dry grinding. The PHT bond is designed for dry grinding and allows cool grinding, even without coolant.

**Special features:**

- The characteristics of the resinoid bond can be optimally adjusted to the application.
- Easy to dress.

Shape	D [mm]	X [mm]	U [mm]	H [mm]	Bond	Grit size		Item no.	Designation	Price/unit EUR
12V9	100	2	10	20	PHT	B 126	1	68662022	12V9 100-2-10-20 B 126 PHT C75	-

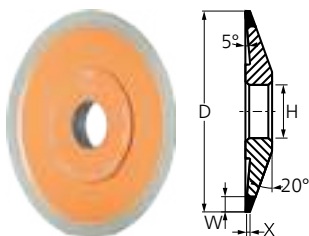

### Shape 4BT9

Phenolic resin bond for high-performance dry grinding. The PHT bond is designed for dry grinding and allows cool grinding, even without coolant.

**Special features:**

- The characteristics of the resinoid bond can be optimally adjusted to the application.
- Easy to dress.



Shape	D [mm]	W [mm]	X [mm]	H [mm]	Bond	Grit size		Item no.	Designation	Price/unit EUR
4BT9	100	6	1	20	PHT	B 126	1	68665101	4BT9 100-6-1-20 B 126 PHT C75	-



### Shape 1A1R

Phenolic resin bond for high-performance dry grinding. The PHT bond is designed for dry grinding and allows cool grinding, even without coolant.

**Special features:**

- The characteristics of the resinoid bond can be optimally adjusted to the application.

- Easy to dress.

Shape	D [mm]	T [mm]	X [mm]	H [mm]	Bond	Grit size		Item no.	Designation	Price/unit EUR
1A1R	100	1	5	20	PHT	B 151	1	68670102	1A1R 100-1-5-20 B 151 PHT C100	-

## Sharpening block for diamond and CBN tools

### Sharpening block for diamond and CBN tools

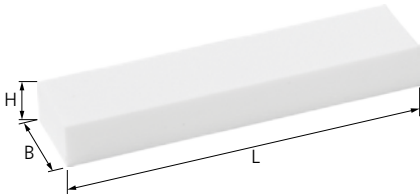

Used to restore the sharpness of resinoid-bonded diamond and CBN grinding discs. The sharpening block is first soaked in coolant and then fed in. The grinding process restores the sharpness very quickly.

L [mm]	B [mm]	H [mm]		Item no.	Designation	Price/unit EUR
100	24	13	5	68402413	SBL 1002413	-



# Diamond cut-off wheels for the construction industry

General information

**PFERD**



## Shape DS

Segmented type for fast cutting



## Shape DG

Type with continuous rim for easy cutting (TURBO)



## Shape DG FL

Type with continuous rim for very fine cutting, e.g. tiles and glazed tiles

## The quick way to find the perfect tool

Application	Material	Tools	
<b>Aggressive, fast cutting</b>	<ul style="list-style-type: none"> <li>■ Concrete (medium-hard, reinforced, hard)</li> <li>■ Aerated concrete</li> <li>■ Pumice</li> <li>■ Brick</li> <li>■ Soft clinker brick</li> <li>■ Sand-lime brick</li> </ul>	Cut-off wheels of the type DS <ul style="list-style-type: none"> <li>■ Universal Line PSF</li> <li>■ Performance Line SG</li> </ul>	
<b>Easy cutting with high cutting quality</b>	<ul style="list-style-type: none"> <li>■ Fresh concrete</li> <li>■ Screed</li> <li>■ Firebrick</li> </ul>	Cut-off wheels of the type DG <ul style="list-style-type: none"> <li>■ Performance Line SG</li> </ul>	
	<ul style="list-style-type: none"> <li>■ Sandstone</li> <li>■ Clay brick</li> <li>■ Slate</li> <li>■ Granite</li> <li>■ Marble</li> </ul>	Cut-off wheels of the type DG <ul style="list-style-type: none"> <li>■ Universal Line PSF</li> <li>■ Performance Line SG</li> </ul>	
	<ul style="list-style-type: none"> <li>■ Glazed tiles</li> <li>■ Ceramic tiles</li> <li>■ Porcelain stoneware</li> <li>■ Slate</li> <li>■ Marble</li> </ul>	Cut-off wheels of the type DG FL <ul style="list-style-type: none"> <li>■ Universal Line PSF</li> <li>■ Performance Line SG</li> </ul>	

5

## Segmented type for fast cutting

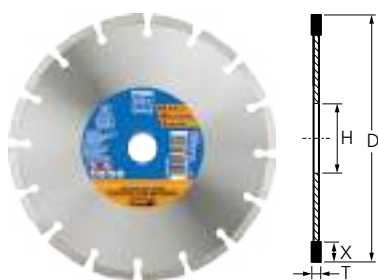

### DS PSF type

General-purpose segmented-rim tool for aggressive, fast cutting with high cutting performance and a good tool life.

#### Special features:

- High diamond qualities.
- Excellent cutting characteristics and short cutting times.
- High ease of cutting and economic efficiency.

D [mm]	T [mm]	H [mm]	X [mm]	Max. RPM		Item no.	Designation	Price/unit EUR
115	2.2	22.23	7	13,300	1	68011221	DS 115 x 2,2 x 22,23 PSF	-
125	2.2	22.23	7	12,200	1	68012221	DS 125 x 2,2 x 22,23 PSF	-
178	2.4	22.23	7	8,600	1	68017221	DS 178 x 2,4 x 22,23 PSF	-
230	2.4	22.23	7	6,600	1	68023223	DS 230 x 2,4 x 22,23 PSF	-

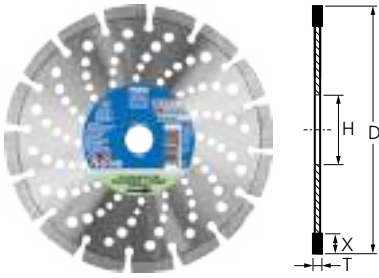

### DS SG type

High-performance segmented-edge tool for aggressive, fast cutting of hard materials with high cutting performance and very good tool life.



#### Contents:

All diamond cut-off wheels with a centre hole diameter of 25.4 mm are supplied with a reducing ring to 22.23 mm for use on angle grinders.

#### Special features:

- High diamond qualities.
- Excellent cutting characteristics and short cutting times.
- High ease of cutting and economic efficiency.

D [mm]	T [mm]	H [mm]	X [mm]	Max. RPM		Item no.	Designation	Price/unit EUR
115	2.4	22.23	10	13,300	1	68000041	DS 115 x 2,4 x 22,23 SG	-
125	2.4	22.23	10	12,200	1	68000042	DS 125 x 2,4 x 22,23 SG	-
178	2.6	22.23	10	8,600	1	68000043	DS 178 x 2,6 x 22,23 SG	-
230	2.8	22.23	10	6,600	1	68000044	DS 230 x 2,8 x 22,23 SG	-
300	2.8	20	10	6,400	1	68000045	DS 300 x 2,8 x 20,0 SG	-
		25.4	10	6,400	1	68000046	DS 300 x 2,8 x 25,4 SG	-
350	2.8	20	10	5,400	1	68000047	DS 350 x 2,8 x 20,0 SG	-
		25.4	10	5,400	1	68000048	DS 350 x 2,8 x 25,4 SG	-
400	3.2	25.4	10	4,800	1	68000049	DS 400 x 3,2 x 25,4 SG	-

## Type with continuous rim for easy cutting (TURBO)

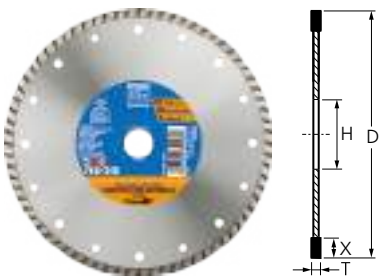

### DG PSF type

General-purpose continuous-rim tool for easy cutting (TURBO) with high cutting performance and a good tool life.



#### Special features:

- High diamond qualities.
- Excellent cutting characteristics and short cutting times.
- High ease of cutting and economic efficiency.

D [mm]	T [mm]	H [mm]	X [mm]	Max. RPM		Item no.	Designation	Price/unit EUR
115	2.1	22.23	7	13,300	1	68011222	DG 115 x 2,1 x 22,23 PSF	-
125	2.1	22.23	7	12,200	1	68012222	DG 125 x 2,1 x 22,23 PSF	-
178	2.4	22.23	7	8,600	1	68017222	DG 178 x 2,4 x 22,23 PSF	-
230	2.6	22.23	7	6,600	1	68023222	DG 230 x 2,6 x 22,23 PSF	-



# Diamond cut-off wheels for the construction industry

Type with continuous rim for easy cutting (TURBO)



## DG SG type

High-performance continuous-edge tool for easy cutting (TURBO) with high cutting performance and very good tool life.

### Special features:

- High diamond qualities.
- Excellent cutting characteristics and short cutting times.
- High ease of cutting and economic efficiency.

D [mm]	T [mm]	H [mm]	X [mm]	Max. RPM		Item no.	Designation	Price/unit EUR
115	2.2	22.23	8	13,300	1	68000021	DG 115 x 2,2 x 22,23 SG	-
125	2.2	22.23	8	12,200	1	68000022	DG 125 x 2,2 x 22,23 SG	-
178	2.5	22.23	8	8,600	1	68000023	DG 178 x 2,5 x 22,23 SG	-
230	2.8	22.23	8	6,600	1	68000024	DG 230 x 2,8 x 22,23 SG	-

## Type with continuous rim for very fine cutting



## DG FL PSF type

General-purpose continuous-rim tool for cutting without edge breakages on workpieces with high-quality surfaces. High cutting performance and good tool life.

### Special features:

- High diamond qualities.
- Excellent cutting characteristics and short cutting times.
- High ease of cutting and economic efficiency.

D [mm]	T [mm]	H [mm]	X [mm]	Max. RPM		Item no.	Designation	Price/unit EUR
115	1.6	22.23	7	13,300	1	68000011	DG 115 x 1,6 x 22,23 FL PSF	-
125	1.6	22.23	7	12,200	1	68000012	DG 125 x 1,6 x 22,23 FL PSF	-



## DG FL SG type

High-performance continuous-rim tool for cutting without edge breakages on workpieces with high-quality surfaces. High cutting performance and very good tool life.



### Special features:

- High diamond qualities.
- Excellent cutting characteristics and short cutting times.
- High ease of cutting and economic efficiency.

D [mm]	T [mm]	H [mm]	X [mm]	Max. RPM		Item no.	Designation	Price/unit EUR
115	1.4	22.23	8	13,300	1	68000031	DG 115 x 1,4 x 22,23 FL SG	-
125	1.4	22.23	8	12,200	1	68000032	DG 125 x 1,4 x 22,23 FL SG	-



### Sharpening block DSB

The sharpening block is used to resharpen metal-bonded diamond cut-off wheels (e.g. after cutting lubricating materials).

L [mm]	B [mm]	H [mm]	Grit size		Item no.	Designation	Price/unit EUR
200	50	25	80	1	68075025	DSB 2005025	-





Files



Milling, drilling and countersinking tools



Mounted points



Fine grinding and polishing tools



Diamond and CBN tools



Cut-off wheels, flap discs and grinding wheels



Cut-off wheels for stationary applications



Industrial power brushes



Tool drives



Cutting tools for stationary applications

5

## New additions to the PFERD product range



Stay up to date and discover our new products digitally and online. Our new products have **blue** item numbers in the Tool Manual.