

Fine grinding and polishing tools

Fine grinding and polishing tools

■ Highlights from the PFERD range	4
■ General information	5
■ The quick way to find the perfect tool	7
■ Coated abrasives	9



COMBICLICK

■ Fibre discs CC-FS	13
■ Non-woven discs	18
■ Felt discs CC-FR	20
■ Backing pad	21
■ COMBICLICK set	22

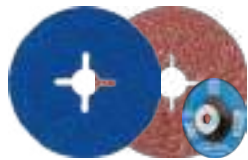

Fibre discs

■ Fibre discs FS	24
■ Backing pad	30
■ Stand	31



Self-adhesive discs

■ Self-adhesive discs KR	32
■ Self-adhesive disc holders KRH	33



Self-adhesive abrasive discs

■ Self-adhesive abrasive discs PSA	34
■ Abrasive disc holder PSA-H	35

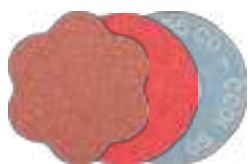

COMBIDISC

■ Mini-POLIFAN CD, CDR	37
■ Mini-POLIFAN arbor	38
■ Abrasive discs CD, CDR	39
■ POLICLEAN discs CD, CDR	51
■ Non-woven discs CD, CDR	52
■ TX discs CD	54
■ Felt discs CD, CDR	55
■ Abrasive disc holder	55
■ COMBIDISC set	56
■ DUST REMOVER	57



Flexible abrasives

■ Short belts BA	59
■ Short belts VB	65
■ Short belts P-BA	67
■ Belts for pneumatic drums	67
■ Pneumatic drum	69
■ Long belts BA	69
■ Cloth-backed abrasive sheets BG	74
■ Paper-backed abrasive sheets BP	75
■ Hand pads	76
■ Shop rolls SBR	77
■ Shop rolls SBR-P	78
■ Shop roll holder SRH	79
■ POLINOX non-woven shop rolls VBR	79
■ Abrasive cord	80
■ Velcro-backed abrasive discs KSS	80
■ Velcro-backed abrasive discs KSS-NET	81
■ Velcro-backed abrasive disc holder	82



Abrasive spiral bands

■ Small pack KSB	84
■ Bulk pack GSB	85
■ Rubber drum holder GK	91



POLIROLL, POLICO

■ POLIROLL cartridge rolls PR and PRK, POLICO abrasive cones PCO	93
■ Arbor and set	95



POLICAP

■ POLICAP (PC), shape ZYA	97
■ POLICAP abrasive cap holder (PCT), shape ZYA	97
■ POLICAP set (PCS), shape ZYA	98
■ POLICAP (PC), shape WRC	98
■ POLICAP abrasive cap holder (PCT), shape WRC	99
■ POLICAP set (PCS), shape WRC	100
■ POLICAP (PC), shape WKG	100
■ POLICAP abrasive cap holder (PCT), shape WKG	101
■ POLICAP set (PCS), shape WKG	101
■ POLICAP (PC), shape KEL	102
■ POLICAP abrasive cap holder (PCT), shape KEL	103
■ POLICAP set (PCS)	103
■ POLICAP abrasive spiral bands (PCH), conical shape	104
■ POLICAP rubber drum holder (PCT), shape KEL	104
■ Rubber drum holder GK, conical shape	104



Flap tools

■ Mounted flap wheels F	106
■ Mounted flap wheel set	113
■ Unmounted flap wheels FR	114
■ Arbor FR/VR	115
■ Unmounted flap wheels for angle grinders	116
■ Flap drums	118
■ Drums, set FR-W	118
■ POLIFLAP tools	119
■ Overlap slotted discs KS	120
■ Arbor for overlap slotted discs BO KS	120
■ POLISTAR	121
■ POLISTAR-TUBE	123
■ Arbor for POLISTAR and POLISTAR-TUBE	124



Sanding sticks

■ Flexible sanding sticks	125
■ Ceramic fibre files	126



Non-woven tools

■ POLINOX unitized wheels PNER	131
■ Arbor for POLINOX unitized/convolute wheels	132
■ POLINOX unitized discs PNER	133
■ POLINOX convolute wheels PNK	135
■ Clamping flanges for POLINOX convolute wheels PNK	136
■ POLINOX mounted grinding wheels	136
■ POLINOX cross buffs	140
■ POLINOX unmounted grinding wheels	141
■ Arbor for POLINOX grinding wheels	143
■ Reducing flanges for POLINOX grinding wheels RF	143
■ Threaded POLINOX grinding wheels	144
■ POLINOX grinding discs	145
■ POLINOX grinding drums	146
■ POLINOX discs	148
■ Arbor for POLINOX discs	148
■ Accessories	149
■ POLINOX marbling tools	149
■ POLIVLIES grinding discs	150
■ Self-adhesive disc holders PVKRH	152
■ POLICLEAN tools	152

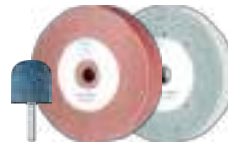

Poliflex tools

■ PUR bond	157
■ PU-STRUC bond	160
■ GR bond	161
■ GHR bond	162
■ Arbor BO	163
■ LR bond	164
■ LHR bond	165
■ TX bond	166



Polishing tools

■ Felt points FK	169
■ Mounted felt flap wheels	173
■ Felt wheels and lenses FK SC/LI	173
■ Felt flap discs FFS	174
■ Felt sheets FK P	175
■ Cloth rings	175
■ Arbor	176



Grinding oils and polishing pastes

■ Grinding and polishing pastes	177
■ Diamond polishing pastes	178
■ Grinding oils	179
■ Cleaner	179



Fine grinding and polishing tools

Highlights from the PFERD range



COMBICLICK

The COMBICLICK system consists of a specially developed backing pad and a rugged mounting system at the back of the tool.



The backing pad enables COMBICLICK tools to be used on conventional angle grinders for the use of fibre discs and non-woven and felt tools.

The unique geometry of the cooling slots in the backing pad ensures high air throughput, which in turn considerably reduces the thermal load on the abrasive material and the workpiece.

Compared with conventional tools, the quick-mounting system, robust holder, secure tool-locking feature and integrated cooling system together achieve a workpiece temperature that is up to 30% lower, a 25% higher stock removal rate, a 30% longer tool life and better utilization of the abrasive material.

Scan the QR code to find out more about the COMBICLICK range.



VICTOGRAIN

VICTOGRAIN products are some of the most effective grinding tools in the world. The triangular, precision-formed abrasive grain from PFERD helps provide a uniquely high level of abrasive performance. The **VICTOGRAIN** abrasive grit triangles are identical in shape and size and their cutting edges are applied to the workpiece at the optimum angle, meaning the grit needs very little energy to penetrate the workpiece. The user thus benefits from an efficient machining process with fast work progress, a long tool life, a reduced influx of heat into the workpiece and a lower power output required for the tool drive.



By combining all these properties together, users benefit from the ultimate, constant performance during cool grinding and an extremely long tool life together with consistent workpiece surface roughness.

Scan the QR code to find out more about the **VICTOGRAIN** products.

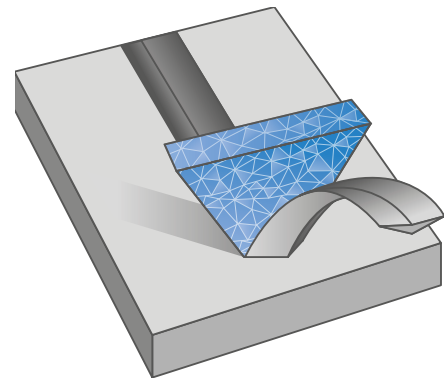

Non-woven tools

Non-woven abrasives come into their own where other grinding tools reach their limits and are unable to produce the desired results. The elastic properties of the polyamide fibres and the positive effect of the non-woven abrasive give rise to outstanding, gentle finishing tools.



Non-woven abrasives consist of polyamide fibres, synthetic resins and abrasive grain. The even distribution of the abrasive grain within the non-woven mixture guarantees a continuous supply of fresh, sharp abrasive grain during the entire grinding operation. Non-woven abrasives do not clog up, do not leave rust on surfaces and are not conductive.

Non-woven abrasive material is excellent when used for deburring, cleaning or working on the surface of many metals, including aluminium, brass, copper, nickel, stainless steel (INOX) and titanium. It is also suitable for working on other hard-to-grind materials, such as ceramic, glass and plastic.

Scan the QR code to find out more about PFERD's wide range of non-woven tools.



Custom-made products

If you cannot find the solution for your particular application in our extensive catalogue range, we can produce fine grinding and polishing tools in premium PFERD quality specifically for your application on request.

We can take into account your specifications and needs, drawings, information on dimensions and shapes, grit sizes and grain types, grain mixtures, shank diameters and shank lengths. Please speak to our sales representatives. We will be happy to advise you.



Factors that influence the surface roughness:

The abrasive material, the material you will be working on and the machining parameters all affect the surface roughness. As a general rule:

- The larger the grain, the rougher the surface produced.
- The softer the material that is being machined, the coarser the surface produced when using the same grit size.
- The increase in cutting speed leads to a slightly better surface quality.
- Reducing the feed rate produces a slightly finer surface quality.



A distinction is made between the following roughness depths:

- **Individual roughness depth R_{z_i}**
The sum of the height of the largest profile peak and the depth of the largest profile trough within an individual measuring section.
- **Roughness depth R_z**
The mean value of the individual roughness depths (R_{z_i}) of consecutive individual measuring sections.
- **Roughness depth R_{max}**
The largest individual roughness depth within the overall measuring section.
- **Average roughness value R_a**
The arithmetic average of the amounts of all values of the roughness profile.

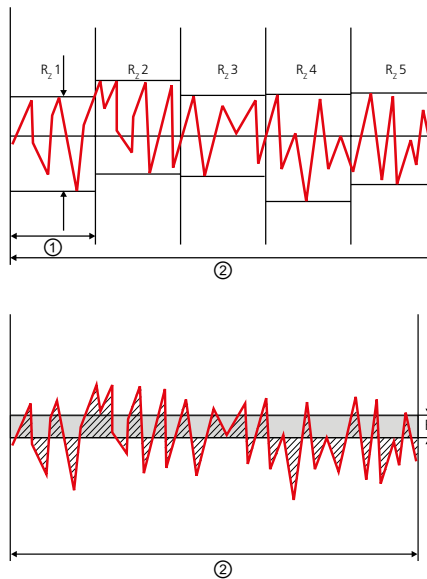

① Individual measuring section
② Overall measuring section

Application	Roughness depth
Coarse grinding: grit sizes 24 to 150	$R_a = 0.70$ to $12 \mu\text{m}$
Fine grinding: grit sizes 180 to 400	$R_a = 0.20$ to $0.70 \mu\text{m}$
Very fine grinding: grit sizes 500 to 1200	$R_a = 0.05$ to $0.20 \mu\text{m}$
Structuring: surfaces ground	$R_a = 0.20$ to $0.70 \mu\text{m}$
Satin finishing/ matt finishing: with non-woven abrasive	$R_a = 0.10$ to $0.70 \mu\text{m}$
Polishing: Step 1: Step 2: Step 3:	$R_a = 0.10$ to $0.20 \mu\text{m}$ $R_a = 0.04$ to $0.10 \mu\text{m}$ $R_a < 0.01 \mu\text{m}$

Reference values for roughness depths in the case of different applications.



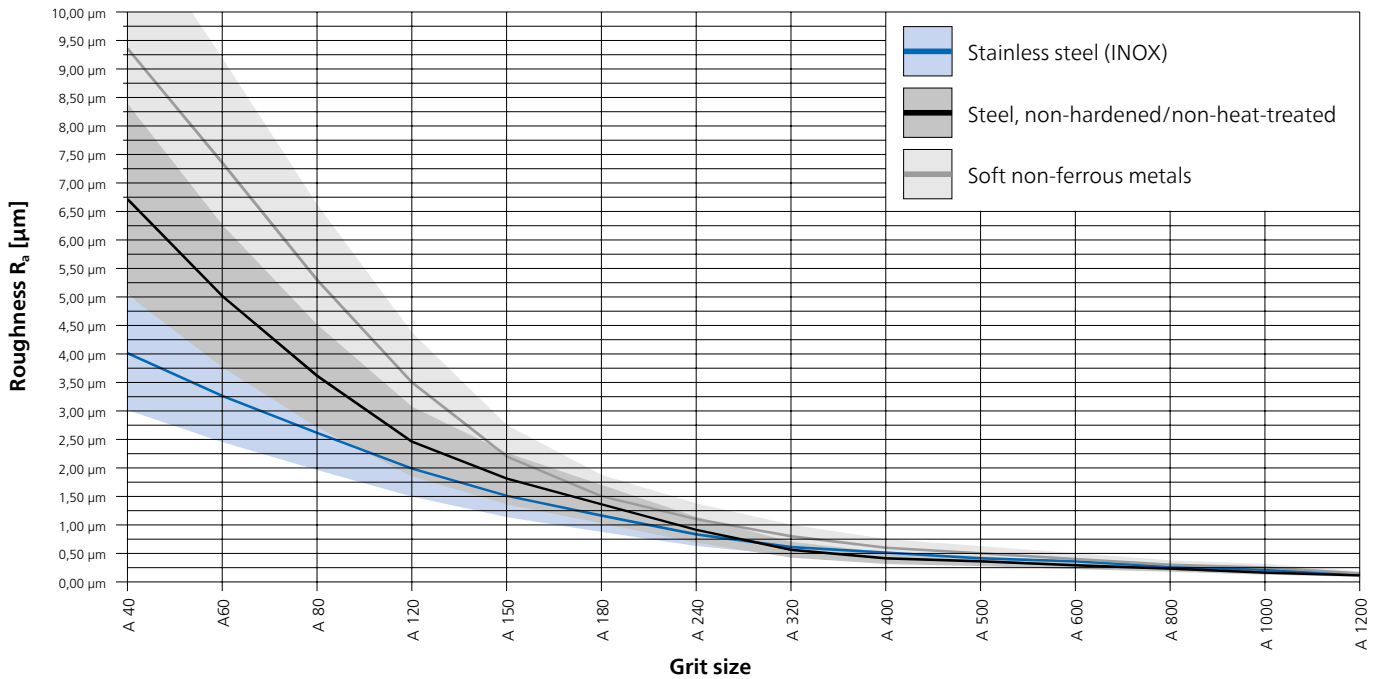

Fine grinding and polishing tools

General information



Surface roughness of different materials after machining with tools using coated abrasives.































































<p>Work type ▶</p> <p>Work steps ▼</p>	<p>Face-down grinding Tools with backing pad</p> 	<p>Belt grinding Tools for belt sanders</p> 	
<p>Changing geometrical profiles</p> 	<p>COMBIDISC</p> <ul style="list-style-type: none"> Abrasive discs Diamond abrasive discs <p>COMBIDISC midget fibre discs</p> <p>COMBIDISC Mini-POLIFAN</p>	<p>Self-adhesive discs</p> <p>Fibre discs</p> <p>COMBICLICK fibre discs</p>	<p>Short belts</p> <p>Long belts</p>
<p>Step-by-step fine grinding Reducing roughness depths</p> 	<p>COMBIDISC</p> <ul style="list-style-type: none"> Abrasive discs Non-woven discs <p>Poliflex discs</p> <p>COMBICLICK non-woven discs</p> <p>POLINOX unitized discs</p> <p>POLINOX discs</p> <ul style="list-style-type: none"> PNL PNZ 	<p>Self-adhesive discs</p> <p>PSA discs</p> <p>Velcro-backed abrasive discs</p> <p>Fibre discs</p> <p>COMBICLICK fibre discs</p>	<p>Short belts</p> <p>Long belts</p>
<p>Fine grinding Very fine grinding</p> 	<p>Grinding oils</p> <p>COMBIDISC</p> <ul style="list-style-type: none"> Abrasive discs Non-woven discs <p>Poliflex discs</p> <p>POLINOX unitized discs</p>	<p>Fibre discs</p> <p>PSA discs</p> <p>COMBICLICK fibre discs</p>	<p>Grinding oils</p> <p>Short belts</p> <p>Long belts</p> <p>Short belts, non-woven</p>
<p>Cleaning</p> 	<p>COMBIDISC non-woven discs</p> <p>COMBIDISC POLICLEAN discs</p> <p>COMBICLICK non-woven discs</p>	<p>POLIVLIES self-adhesive discs</p> <p>POLICLEAN discs</p>	<p>Short belts, non-woven</p>
<p>Creating visual effects</p> 	<p>COMBIDISC non-woven discs</p> <p>COMBIDISC TX discs</p> <p>POLIVLIES flap discs</p> <p>POLINOX discs</p> <ul style="list-style-type: none"> PNL PNZ 	<p>POLIVLIES self-adhesive discs</p> <p>Marbling tools</p> <p>Poliflex structuring tools</p> <p>COMBICLICK non-woven discs</p>	<p>Short belts, non-woven</p>
<p>Polishing</p> 	<p>COMBIDISC felt discs</p> <p>COMBICLICK felt discs</p>	<p>Felt flap discs</p>	<p>Short belts, felt</p>



Fine grinding and polishing tools

The quick way to find the perfect tool



<p>Work type ▶</p> <p>Work steps ▼</p>	<p>Peripheral grinding Mounted tools, tools with arbor holes</p> 		<p>Manual grinding</p> 
<p>Changing geometrical profiles</p> 	 Abrasive spiral bands	 POLICAP	
<p>Step-by-step fine grinding Reducing roughness depths</p> 	 Abrasive spiral bands	 Unmounted flap wheels for angle grinders	 Poliflex blocks
	 POLIROLL, POLICO	 Overlap slotted discs	 Ceramic fibre files
	 POLICAP	 POLISTAR	 Abrasive sheets Cloth/paper
	 Mounted flap wheels	 Overlap slotted discs	 Shop rolls Cloth/paper
	 Unmounted flap wheels		 Flexible sanding sticks
<p>Fine grinding Very fine grinding</p> 	 POLIROLL, POLICO	 Poliflex fine grinding points	 Poliflex blocks
	 Grinding oils	 POLINOX unitized/convolute wheels	 Abrasive sheets Cloth/paper
	 Poliflex fine grinding discs		 Shop rolls Cloth/paper
			 Diamond hand pads
<p>Cleaning</p> 	 POLINOX mounted grinding wheels	 POLINOX grinding drums	 Abrasive sheets Cloth/paper
	 POLINOX unmounted grinding wheels	 POLICLEAN wheels	 POLINOX hand pads
	 POLINOX cross buffs	 POLICLEAN mounted tools	 Shop rolls Cloth/paper
			 Non-woven shop rolls
<p>Creating visual effects</p> 	 POLINOX mounted grinding wheels	 POLIFLAP grinding wheel	 POLINOX hand pads
	 POLINOX unmounted grinding wheels	 Poliflex structuring tools	 Non-woven shop rolls
	 POLINOX discs	 Flap drums	 Masking tape
	 POLINOX grinding drums		
<p>Polishing</p> 	 Felt points	 Mounted felt flap wheels	 Diamond polishing pastes
	 Felt wheels and lenses	 Cloth rings	 Polishing paste bars
			 Grinding pastes

Structure of coated abrasives

PFERD offers a wide selection of coated abrasive tools for working on different workpiece geometries and materials.

- ① Backing material
- ② Base bond
- ③ Coating bond
- ④ Abrasive grain
- ⑤ Active grinding layer

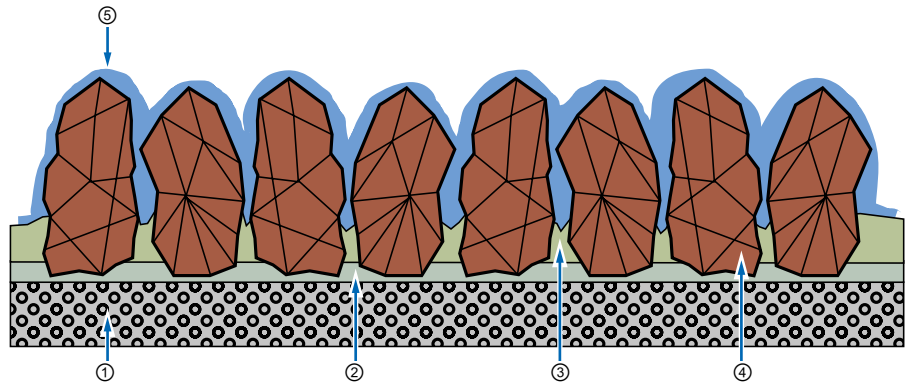

① Backing material

Paper

The main areas of application for coated abrasives with a paper base are in the wood-working industry and in trade, e.g. among carpenters, painters and decorators.

Cloth

Coated abrasives with a cloth base are predominantly used for metalworking.

Vulcanized fibre

When adapted to the corresponding applications, vulcanized fibre in various thicknesses is predominantly used for making fibre grinding discs. Vulcanized fibre is a very sturdy, robust backing material, and also very wear-resistant.

② + ③ bond

When manufacturing coated abrasives, different resin bonds are used to fix the abrasive grain to the backing material. First, the backing material is coated with the base bond ②. After this, the abrasive grain is evenly scattered over the surface and aligned to achieve higher aggressiveness with the help of special procedures. The coating bond ③ ensures that the abrasive grain is fixed in place and protects the grain against the forces and loads resulting from the grinding process.

④ Abrasive grain

Selecting the right abrasive grain has a great influence on the surface quality and efficiency. The most common abrasive grain materials are:



Aluminium oxide A

Numerous types of aluminium oxide are used as abrasives. These may be present in molten or sintered form. The hardness and toughness can be influenced by special manufacturing procedures or additives. Standard types of aluminium oxide and a "sharp-edged" grain shape are predominantly used for coated abrasives.



Silicon carbide SiC

Silicon carbide is synthetically manufactured abrasive grain which is very sharp-edged, with low toughness and very high hardness. It is particularly suitable for work on titanium, aluminium, bronze, stone and plastics. Ideally suited for use in the aeronautical industry, especially where SiC is the only approved abrasive, e.g. for use on engine components.



Zirconia alumina Z

Zirconia alumina is a fused mixture of aluminium oxide and zirconium oxide. In comparison to aluminium oxides, zirconia alumina exhibits lower hardness but greater toughness. The high proportion of zirconium oxide results in an extremely powerful self-sharpening effect and contributes to outstanding stock removal rates with cool grinding and a long tool life.



Diamond grain D

Diamond grain is the hardest abrasive. It consists of pure carbon in a crystalline structure. For grinding tools, the diamonds used are generally produced synthetically at very high temperatures and under high pressure. The properties of diamond grain can be adapted for use in grinding tools through various synthesis conditions.



Fine grinding and polishing tools

Coated abrasives

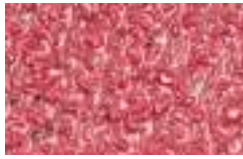

Ceramic oxide grain CO

For sintered aluminium oxides, a differentiation is made between sintered bauxite aluminium oxides and sol-gel aluminium oxides. Sol-gel aluminium oxides are predominantly used for coated abrasives in the form of abrasive ceramic grain. This state-of-the-art abrasive is used for numerous applications thanks to its high toughness and good self-sharpening qualities.



VICTOGRAIN

The triangular, precision-formed VICTOGRAIN abrasive grain achieves uniquely high abrasive performance. The VICTOGRAIN abrasive grain triangles are fixed to the substrate on one of their sides. This means they are securely fixed in place and, together with their slim design, offer an extremely large chip space in order to further improve machining efficiency. The structure of the triangular VICTOGRAIN has also been specially adapted to maximize results. The very small crystals inside the triangles ensure optimal wear characteristics as sharp cutting edges are always exposed, but only the minimum amount of abrasive grain/ the triangle breaks off. By combining all these properties together, users benefit from the ultimate, constant performance during cool grinding and an extremely long tool life together with consistent workpiece surface roughness.



Compact grain CK

In the case of compact grain, individual grains are built up as granulate with a bond system. Each individual grain of granulate is one solid unit, in which numerous abrasive grains made from aluminium oxide or silicon carbide (SiC) are joined together. Used abrasive grains are torn out of this compound structure by the forces resulting from the grinding, and expose sharp abrasive points in doing so. This guarantees a long tool life with a constant surface quality.

4

Grit sizes

The various grit sizes for coated abrasives are set out in ISO 6344 and have been adopted in FEPA standards.



Coarse

P 12 – 16 – 20 – 24 – 36 – 40 – 50 – 60 – 80



Medium

P 100 – 120 – 150 – 180 – 220 – 240 – 280



Fine

P 320 – 360 – 400 – 500 – 600



Ultra-fine

P 800 – 1,000 – 1,200 – 1,500

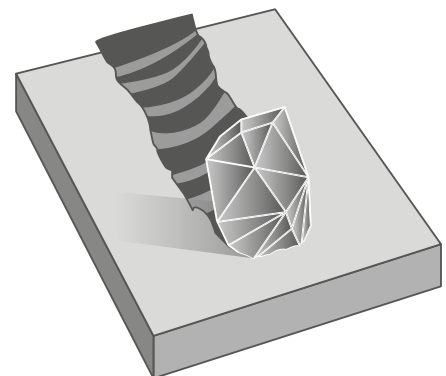

⑤ Active grinding layer

The use of an active grinding layer significantly increases the stock removal rate and reduces the workpiece temperature. This is particularly advantageous for materials which conduct heat poorly, such as stainless steel (INOX). PFERD tools with an active grinding layer have the suffix "COOL" in the item designation.





System

Very easy and convenient to use.



Clamping

Extremely quick and easy tool changes, which reduces process costs.



Cooling effect

Excellent cooling of the tool and workpiece.



Flexible grinding

Particularly soft and flexible grinding performance during face-down grinding with fibre disc dia. 125 mm.



COMBICLICK can be used at extremely low angles

Using COMBICLICK helps to avoid scratches caused by protruding clamping pieces, and exploits the abrasive material that is available.



By way of comparison, the contact angle for fibre discs is much steeper.



The quick way to find the perfect tool

			Abrasive ▶								
Material group ▼			Aluminium oxide A	Zircon Z	Ceramic oxide grain CO	VICTOGRAIN	Silicon carbide SiC	Aluminium oxide A-COOL	Ceramic oxide grain CO-COOL	Ceramic oxide grain CO-ALU	VICTOGRAIN-COOL
Steel, cast steel	Non-hardened, non-heat-treated steels	Construction steels, carbon steels, tool steels, non-alloyed steels, cast steel	•	○	•	•					○
	Hardened, heat-treated steels	Tool steels, tempering steels, alloyed steels, cast steel	○	•	•	•					○
Stainless steel (INOX)	Rust and acid-resistant steels	Austenitic and ferritic stainless steels		○		○		•	•		•
Non-ferrous metals	Soft non-ferrous metals, non-ferrous metals	Soft aluminium alloys	○					•	○	○	
		Brass, copper, zinc	•	○	○					○	
	Hard non-ferrous metals	Hard aluminium alloys	•	○	○		○			○	
		Bronze, titanium		○	○	○	•		•		•
	High-temperature-resistant materials	Nickel-based and cobalt-based alloys		○	○	○		•	○	•	
Cast iron	Grey cast iron, white cast iron	Cast iron with flake graphite EN-GJL (GG), with nodular graphite/nodular cast iron EN-GJS (GGG), white annealed cast iron EN-GJMW (GTW), black annealed cast iron EN-GJMB (GTS)	•	○	•						
Plastics, other materials		Fibre-reinforced plastics, thermoplastics, wood, chipboard, paint	•				•				

• = highly suitable ○ = suitable

Safety notes

- The maximum permitted peripheral speed is 80 m/s.
- For safety reasons, the maximum permitted rotational speed indicated must never be exceeded.



Wear eye protection!



Wear hearing protection!



Wear gloves!



Wear a dust mask!



Use backing pad!



Follow the safety instructions!



Not permitted for wet grinding!





Aluminium oxide A version

For general grinding work from coarse to fine grinding in industry and professional trades.

Special features:

- The innovative quick-mounting system ensures convenient handling and cool grinding.
- High economic efficiency thanks to long tool life and very high stock removal rate. Consistent surface finish thanks to high-quality abrasives.
- Please order necessary backing pad separately.

D [mm]	Abrasive	Grit size	Max. RPM		Item no.	Designation	Price/unit EUR
100	A	36	15,300	25	64189001	CC-FS 100 A 36	-
		50	15,300	25	64189002	CC-FS 100 A 50	-
		60	15,300	25	64189003	CC-FS 100 A 60	-
		80	15,300	25	64189004	CC-FS 100 A 80	-
		120	15,300	25	64189005	CC-FS 100 A 120	-
115	A	24	13,300	25	64190002	CC-FS 115 A 24	-
		36	13,300	25	64190003	CC-FS 115 A 36	-
		50	13,300	25	64190005	CC-FS 115 A 50	-
		60	13,300	25	64190006	CC-FS 115 A 60	-
		80	13,300	25	64190008	CC-FS 115 A 80	-
		120	13,300	25	64190012	CC-FS 115 A 120	-
125	A	24	12,200	25	64190102	CC-FS 125 A 24	-
		36	12,200	25	64190103	CC-FS 125 A 36	-
		50	12,200	25	64190105	CC-FS 125 A 50	-
		60	12,200	25	64190106	CC-FS 125 A 60	-
		80	12,200	25	64190108	CC-FS 125 A 80	-
		120	12,200	25	64190112	CC-FS 125 A 120	-



Zirconia alumina Z version

For coarse grinding work with a high stock removal rate and a long tool life.

Special features:

- The innovative quick-mounting system ensures convenient handling and cool grinding.
- High economic efficiency thanks to long tool life and very high stock removal rate. Consistent surface finish thanks to high-quality abrasives.
- Please order necessary backing pad separately.

D [mm]	Abrasive	Grit size	Max. RPM		Item no.	Designation	Price/unit EUR
115	Z	36	13,300	25	64290003	CC-FS 115 Z 36	-
		50	13,300	25	64290005	CC-FS 115 Z 50	-
		60	13,300	25	64290006	CC-FS 115 Z 60	-
		80	13,300	25	64290008	CC-FS 115 Z 80	-
		120	13,300	25	64290012	CC-FS 115 Z 120	-
125	Z	24	12,200	25	64290102	CC-FS 125 Z 24	-
		36	12,200	25	64290103	CC-FS 125 Z 36	-
		50	12,200	25	64290105	CC-FS 125 Z 50	-
		60	12,200	25	64290106	CC-FS 125 Z 60	-
		80	12,200	25	64290108	CC-FS 125 Z 80	-
		120	12,200	25	64290112	CC-FS 125 Z 120	-



Ceramic oxide grain CO version

For aggressive grinding with maximum stock removal rate and very long tool life. Consistently high performance due to self-sharpening ceramic oxide grain. The ceramic oxide grain is specifically designed for work on hard materials and layers.



Special features:

- The innovative quick-mounting system ensures convenient handling and cool grinding.
- High economic efficiency thanks to long tool life and very high stock removal rate. Consistent surface finish thanks to high-quality abrasives.
- Please order necessary backing pad separately.

D [mm]	Abrasive	Grit size	Max. RPM		Item no.	Designation	Price/unit EUR
115	CO	24	13,300	25	64192002	CC-FS 115 CO 24	-
		36	13,300	25	64192003	CC-FS 115 CO 36	-
		50	13,300	25	64192005	CC-FS 115 CO 50	-
		60	13,300	25	64192006	CC-FS 115 CO 60	-
		80	13,300	25	64192008	CC-FS 115 CO 80	-
		120	13,300	25	64192012	CC-FS 115 CO 120	-
125	CO	24	12,200	25	64192102	CC-FS 125 CO 24	-
		36	12,200	25	64192103	CC-FS 125 CO 36	-
		50	12,200	25	64192105	CC-FS 125 CO 50	-
		60	12,200	25	64192106	CC-FS 125 CO 60	-
		80	12,200	25	64192108	CC-FS 125 CO 80	-
		120	12,200	25	64192112	CC-FS 125 CO 120	-



VICTOGRAIN version

For maximum aggressive grinding with an extremely long tool life and the ultimate stock removal rate on steel and hard materials. The ultimate, consistently high performance.



Special features:

- The innovative quick-mounting system ensures convenient handling and cool grinding.
- High economic efficiency thanks to long tool life and very high stock removal rate. Consistent surface finish thanks to high-quality abrasives.
- Please order necessary backing pad separately.

D [mm]	Abrasive	Grit size	Max. RPM		Item no.	Designation	Price/unit EUR
100	VICTOGRAIN	36	15,300	25	64110136	CC-FS 100 VICTOGRAIN 36	-
		60	15,300	25	64110160	CC-FS 100 VICTOGRAIN 60	-
		80	15,300	25	64110180	CC-FS 100 VICTOGRAIN 80	-
115	VICTOGRAIN	36	13,300	25	64111636	CC-FS 115 VICTOGRAIN 36	-
		60	13,300	25	64111660	CC-FS 115 VICTOGRAIN 60	-
		80	13,300	25	64111680	CC-FS 115 VICTOGRAIN 80	-
125	VICTOGRAIN	36	12,200	25	64112636	CC-FS 125 VICTOGRAIN 36	-
		60	12,200	25	64112660	CC-FS 125 VICTOGRAIN 60	-
		80	12,200	25	64112680	CC-FS 125 VICTOGRAIN 80	-
180	VICTOGRAIN	36	8,500	25	64118136	CC-FS 180 VICTOGRAIN 36	-
		60	8,500	25	64118160	CC-FS 180 VICTOGRAIN 60	-
		80	8,500	25	64118180	CC-FS 180 VICTOGRAIN 80	-



Silicon carbide SiC version

For general grinding work on components made of aluminium, copper, bronze, titanium and fibre-reinforced plastics. Particularly recommended for use on titanium alloys. Ideally suited for use in the aircraft industry, particularly when SiC is the only abrasive approved for use.

Special features:

- The innovative quick-mounting system ensures convenient handling and cool grinding.
- High economic efficiency thanks to long tool life and very high stock removal rate. Consistent surface finish thanks to high-quality abrasives.
- Please order necessary backing pad separately.

D [mm]	Abrasive	Grit size	Max. RPM		Item no.	Designation	Price/unit EUR
115	SiC	36	13,300	25	64294003	CC-FS 115 SiC 36	-
		60	13,300	25	64294006	CC-FS 115 SiC 60	-
		80	13,300	25	64294008	CC-FS 115 SiC 80	-
		120	13,300	25	64294012	CC-FS 115 SiC 120	-
125	SiC	36	12,200	25	64294103	CC-FS 125 SiC 36	-
		60	12,200	25	64294106	CC-FS 125 SiC 60	-
		80	12,200	25	64294108	CC-FS 125 SiC 80	-
		120	12,200	25	64294112	CC-FS 125 SiC 120	-



Aluminium oxide A-COOL version

For general grinding work from fine to very fine grinding on materials which do not conduct heat well, e.g. stainless steel (INOX) and aluminium. Active grinding additives substantially improve the stock removal rate, prevent clogging and result in cooler grinding.

Special features:

- The innovative quick-mounting system ensures convenient handling and cool grinding.
- High economic efficiency thanks to long tool life and very high stock removal rate. Consistent surface finish thanks to high-quality abrasives.
- Please order necessary backing pad separately.

D [mm]	Abrasive	Grit size	Max. RPM		Item no.	Designation	Price/unit EUR
115	A-COOL	60	13,300	25	64191006	CC-FS 115 A-COOL 60	-
		80	13,300	25	64191008	CC-FS 115 A-COOL 80	-
		120	13,300	25	64191012	CC-FS 115 A-COOL 120	-
		150	13,300	25	64191015	CC-FS 115 A-COOL 150	-
		220	13,300	25	64191022	CC-FS 115 A-COOL 220	-
125	A-COOL	50	12,200	25	64191105	CC-FS 125 A-COOL 50	-
		60	12,200	25	64191106	CC-FS 125 A-COOL 60	-
		80	12,200	25	64191108	CC-FS 125 A-COOL 80	-
		120	12,200	25	64191112	CC-FS 125 A-COOL 120	-
		150	12,200	25	64191115	CC-FS 125 A-COOL 150	-
		180	12,200	25	64191118	CC-FS 125 A-COOL 180	-
		220	12,200	25	64191122	CC-FS 125 A-COOL 220	-





Ceramic oxide grain CO-COOL version

Consistently high performance and aggressive grinding due to self-sharpening ceramic oxide grain. Active grinding additives improve the stock removal rate, prevent clogging and result in cooler grinding on hard materials which do not conduct heat well.



Special features:

- The innovative quick-mounting system ensures convenient handling and cool grinding.
- High economic efficiency thanks to long tool life and very high stock removal rate. Consistent surface finish thanks to high-quality abrasives.
- Please order necessary backing pad separately.

D [mm]	Abrasive	Grit size	Max. RPM		Item no.	Designation	Price/unit EUR
100	CO-COOL	36	15,300	25	64189101	CC-FS 100 CO-COOL 36	-
		50	15,300	25	64189102	CC-FS 100 CO-COOL 50	-
		60	15,300	25	64189103	CC-FS 100 CO-COOL 60	-
		80	15,300	25	64189104	CC-FS 100 CO-COOL 80	-
		120	15,300	25	69401582	CC-FS 100 CO-COOL 120	-
115	CO-COOL	24	13,300	25	64193002	CC-FS 115 CO-COOL 24	-
		36	13,300	25	64193003	CC-FS 115 CO-COOL 36	-
		50	13,300	25	64193005	CC-FS 115 CO-COOL 50	-
		60	13,300	25	64193006	CC-FS 115 CO-COOL 60	-
		80	13,300	25	64193008	CC-FS 115 CO-COOL 80	-
125	CO-COOL	120	13,300	25	64193012	CC-FS 115 CO-COOL 120	-
		24	12,200	25	64193102	CC-FS 125 CO-COOL 24	-
		36	12,200	25	64193103	CC-FS 125 CO-COOL 36	-
		50	12,200	25	64193105	CC-FS 125 CO-COOL 50	-
		60	12,200	25	64193106	CC-FS 125 CO-COOL 60	-
180	CO-COOL	80	12,200	25	64193108	CC-FS 125 CO-COOL 80	-
		120	12,200	25	64193112	CC-FS 125 CO-COOL 120	-
		24	8,500	25	64193302	CC-FS 180 CO-COOL 24	-
		36	8,500	25	64193303	CC-FS 180 CO-COOL 36	-
		50	8,500	25	64193305	CC-FS 180 CO-COOL 50	-
		60	8,500	25	64193306	CC-FS 180 CO-COOL 60	-
		80	8,500	25	64193308	CC-FS 180 CO-COOL 80	-



Ceramic oxide grain CO-COOL-CONTOUR version

Very flexible and adaptable outer contour that does not cut into the workpiece. Consistently high performance and aggressive grinding due to self-sharpening ceramic oxide grain. Active grinding additives improve the stock removal rate, prevent clogging and result in cooler grinding.



Special features:

- The innovative quick-mounting system ensures convenient handling and cool grinding.
- High economic efficiency thanks to long tool life and very high stock removal rate. Consistent surface finish thanks to high-quality abrasives.
- Use only the CC-GT 115-125 backing pad with M14 or 5/8" thread to maintain the flexibility at the edge of the fibre discs.

D [mm]	Abrasive	Grit size	Max. RPM		Item no.	Designation	Price/unit EUR
125	CO-COOL	60 CONTOUR	12,200	25	64112560	CC-FS 125 CO-COOL 60 CONTOUR	-
		80 CONTOUR	12,200	25	64112580	CC-FS 125 CO-COOL 80 CONTOUR	-
		120 CONTOUR	12,200	25	64112512	CC-FS 125 CO-COOL 120 CONTOUR	-



Ceramic oxide grain CO-ALU version

For aggressive grinding with maximum stock removal rate for machining non-ferrous metals. Consistently high performance due to self-sharpening ceramic oxide grain. Adhesion-reducing additives significantly reduce the chip adhesion and therefore reduce clogging of the fibre discs.

Special features:

- The innovative quick-mounting system ensures convenient handling and cool grinding.
- High economic efficiency thanks to long tool life and very high stock removal rate. Consistent surface finish thanks to high-quality abrasives.
- Please order necessary backing pad separately.

D [mm]	Abrasive	Grit size	Max. RPM		Item no.	Designation	Price/unit EUR
115	CO-ALU	36	13,300	25	64194003	CC-FS 115 CO-ALU 36	-
		60	13,300	25	64194006	CC-FS 115 CO-ALU 60	-
		80	13,300	25	64194008	CC-FS 115 CO-ALU 80	-
125	CO-ALU	36	12,200	25	64194103	CC-FS 125 CO-ALU 36	-
		60	12,200	25	64194106	CC-FS 125 CO-ALU 60	-
		80	12,200	25	64194108	CC-FS 125 CO-ALU 80	-





VICTOGRAIN-COOL version

For maximum aggressive grinding with an extremely long tool life, the ultimate stock removal rate and consistently high performance on steel and hard materials which do not conduct heat well. Active grinding additives in the coating prevent clogging and result in cooler grinding.



Special features:

- The innovative quick-mounting system ensures convenient handling and cool grinding.
- High economic efficiency thanks to long tool life and very high stock removal rate. Consistent surface finish thanks to high-quality abrasives.
- Please order necessary backing pad separately.

D [mm]	Abrasive	Grit size	Max. RPM		Item no.	Designation	Price/unit EUR
100	VICTOGRAIN-COOL	36	15,300	25	64110036	CC-FS 100 VICTOGRAIN-COOL 36	-
		60	15,300	25	64110060	CC-FS 100 VICTOGRAIN-COOL 60	-
		80	15,300	25	64110080	CC-FS 100 VICTOGRAIN-COOL 80	-
115	VICTOGRAIN-COOL	36	13,300	25	64111536	CC-FS 115 VICTOGRAIN-COOL 36	-
		60	13,300	25	64111560	CC-FS 115 VICTOGRAIN-COOL 60	-
		80	13,300	25	64111580	CC-FS 115 VICTOGRAIN-COOL 80	-
125	VICTOGRAIN-COOL	36	12,200	25	64112536	CC-FS 125 VICTOGRAIN-COOL 36	-
		60	12,200	25	64112506	CC-FS 125 VICTOGRAIN-COOL 60	-
		80	12,200	25	64112508	CC-FS 125 VICTOGRAIN-COOL 80	-
180	VICTOGRAIN-COOL	36	8,500	25	64118036	CC-FS 180 VICTOGRAIN-COOL 36	-
		60	8,500	25	64118060	CC-FS 180 VICTOGRAIN-COOL 60	-
		80	8,500	25	64118080	CC-FS 180 VICTOGRAIN-COOL 80	-

Non-woven discs

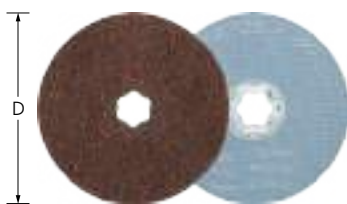

Soft type CC-VRW

Suitable for very fine grinding on medium-sized and large surfaces and contours, and for cleaning metal and painted surfaces. Achieve matt and satin-finished surfaces. Highly open structure.



Special features:

- Ideal for face-down grinding on medium-sized and large surfaces.
- The open structure and high flexibility of the non-woven material prevents tool clogging.
- The innovative quick-mounting system ensures convenient handling and cool grinding. Order necessary backing pad separately.

D [mm]	Abrasive	Grit size	Version	Opt. RPM	Max. RPM		Item no.	Designation	Price/unit EUR
100	A	100	medium	3,800	12,000	10	42001032	CC-VRW 100 A 100	-
		180	fine	3,800	12,000	10	42001031	CC-VRW 100 A 180	-
		280	very fine	3,800	12,000	10	42001030	CC-VRW 100 A 280	-
115	A	100	medium	3,300	10,500	10	42001052	CC-VRW 115 A 100	-
		180	fine	3,300	10,500	10	42001051	CC-VRW 115 A 180	-
		280	very fine	3,300	10,500	10	42001050	CC-VRW 115 A 280	-
125	A	100	medium	3,100	9,650	10	42001062	CC-VRW 125 A 100	-

Continued on next page



D [mm]	Abrasive	Grit size	Version	Opt. RPM	Max. RPM		Item no.	Designation	Price/unit EUR
125	A	180	fine	3,100	9,650	10	42001061	CC-VRW 125 A 180	-
		280	very fine	3,100	9,650	10	42001060	CC-VRW 125 A 280	-



Hard type CC-VRH

Suitable for general work on medium-sized and large metal surfaces, e.g. removing rough grinding traces, removing oxidation and light deburring work. Achieve matt and satin-finished surfaces.



Special features:

- Ideal for face-down grinding on medium-sized and large surfaces.
- Little wear due to high tear strength. The open structure of the non-woven material prevents tool clogging.
- The innovative quick-mounting system ensures convenient handling and cool grinding. Order necessary backing pad separately.

D [mm]	Abrasive	Grit size	Version	Opt. RPM	Max. RPM		Item no.	Designation	Price/unit EUR
100	A	100 G	coarse, yellow-brown	3,800	12,000	10	42000032	CC-VRH 100 A 100 G	-
		180 M	medium, red-brown	3,800	12,000	10	42000031	CC-VRH 100 A 180 M	-
		240 F	fine, blue	3,800	12,000	10	42000030	CC-VRH 100 A 240 F	-
115	A	100 G	coarse, yellow-brown	3,300	10,500	10	42000052	CC-VRH 115 A 100 G	-
		180 M	medium, red-brown	3,300	10,500	10	42000051	CC-VRH 115 A 180 M	-
		240 F	fine, blue	3,300	10,500	10	42000050	CC-VRH 115 A 240 F	-
125	A	100 G	coarse, yellow-brown	3,100	9,650	10	42000062	CC-VRH 125 A 100 G	-
		180 M	medium, red-brown	3,100	9,650	10	42000061	CC-VRH 125 A 180 M	-
		240 F	fine, blue	3,100	9,650	10	42000060	CC-VRH 125 A 240 F	-





CC-PNER type

For achieving a very fine, uniform surface finish which, depending on requirements, is a sufficient preparation for high-gloss polishing. Especially suitable for work on larger surfaces on components made of stainless steel (INOX). Available in the aluminium oxide A and silicon carbide SiC types.



Special features:

- Ideal for face-down grinding on medium-sized and large surfaces.
- High edge strength thanks to extreme durability.
- The innovative quick-mounting system ensures convenient handling and cool grinding. Order necessary backing pad separately.

D [mm]	Abrasive	Version	Grit size	Opt. RPM	Max. RPM		Item no.	Designation	Price/unit EUR
100	SiC	W (soft)	fine	5,700	9,550	5	42002036	CC-PNER W 100 SiC F	-
		MW (medium-soft)	fine	5,700	9,550	5	42002076	CC-PNER MW 100 SiC F	-
		MH (medium-hard)	fine	5,700	9,550	5	42002136	CC-PNER MH 100 SiC F	-
	A	H (hard)	fine	5,700	9,550	5	42002172	CC-PNER H 100 A F	-
115	SiC	W (soft)	fine	5,000	8,350	5	42002046	CC-PNER W 115 SiC F	-
		MW (medium-soft)	fine	5,000	8,350	5	42002086	CC-PNER MW 115 SiC F	-
		MH (medium-hard)	fine	5,000	8,350	5	42002146	CC-PNER MH 115 SiC F	-
	A	H (hard)	fine	5,000	8,350	5	42002182	CC-PNER H 115 A F	-
125	SiC	W (soft)	fine	4,500	7,650	5	42002056	CC-PNER W 125 SiC F	-
		MW (medium-soft)	fine	4,500	7,650	5	42002096	CC-PNER MW 125 SiC F	-
		MH (medium-hard)	fine	4,500	7,650	5	42002156	CC-PNER MH 125 SiC F	-
	A	H (hard)	fine	4,500	7,650	5	42002192	CC-PNER H 125 A F	-

Felt discs CC-FR



CC-FR type

Suitable for polishing with polishing paste bars, grinding pastes or diamond polishing pastes in face-down grinding on medium-sized and large surfaces.



Special features:

- Ideal for face-down grinding on medium-sized and large surfaces.
- High economic efficiency due to very long tool life. Focused working over the entire lifespan thanks to high dimensional stability.
- The innovative quick-mounting system ensures convenient handling and cool grinding. Order necessary backing pad separately.

D [mm]	Opt. RPM	Max. RPM		Item no.	Designation	Price/unit EUR
100	1,900	12,000	5	42003005	CC-FR 100	-
115	1,650	10,500	5	42003015	CC-FR 115	-
125	1,500	9,650	5	42003025	CC-FR 125	-



CC-GT (medium), CC-H-GT (hard) and CC-S-GT (soft) types

With this backing pad, COMBICLICK tools can be used on commercially available angle grinders. Various hardness levels for different applications and results.



Special features:

- The innovative quick-mounting system ensures convenient handling and rapid tool changing.
- The geometry of the cooling slots significantly reduces the thermal load. High economic efficiency due to minimal tool change times.
- The different hardnesses are colour-coded: CC-GT (medium) = black; CC-H-GT (hard) = blue; CC-S-GT (soft) = grey.

Suitable for tool diameter [mm]	Thread	Hardness	Suitable for machine types	Max. RPM		Item no.	Designation	Price/unit EUR
100	M10	medium	Angle grinders 100, spindle M10	15,300	1	44890190	CC-GT 100 M10	-
115, 125	M14	soft	Angle grinders 115 / 125, spindle M14	13,300	1	44890153	CC-S-GT 115-125 M14	-
	5/8	soft	Angle grinders 115 / 125, spindle 5/8"	13,300	1	44890163	CC-S-GT 115-125 5/8-11	-
	M14	medium	Angle grinders 115 / 125, spindle M14	13,300	1	44890150	CC-GT 115-125 M14	-
	5/8	medium	Angle grinders 115 / 125, spindle 5/8"	13,300	1	44890160	CC-GT 115-125 5/8	-
	M14	hard	Angle grinders 115 / 125, spindle M14	13,300	1	64199002	CC-H-GT 115-125 M14	-
	5/8	hard	Angle grinders 115 / 125, spindle 5/8"	13,300	1	64199012	CC-H-GT 115-125 5/8	-
125	M14	medium	Angle grinder 125, spindle M14	12,200	1	44890151	CC-GT 125 M14	-
	5/8	medium	Angle grinders 125, spindle 5/8"	12,200	1	44890161	CC-GT 125 5/8"	-
	M14	hard	Angle grinder 125, spindle M14	12,200	1	44890152	CC-H-GT 125 M14	-
	5/8	hard	Angle grinders 125, spindle 5/8"	12,200	1	44890162	CC-H-GT 125 5/8"	-
180	M14	medium	Angle grinders 180, spindle M14	8,500	1	44890170	CC-GT 180 M14	-
	5/8	medium	Angle grinders 180, spindle 5/8"	8,500	1	44890180	CC-GT 180 5/8	-





CC-SET

Set for work on surfaces, from coarse to mirror-polished. The sets with a diameter of 125 mm are especially flexible around the edge.

Contents:

Three each of the following COMBICLICK fibre discs (CC-FS CO-COOL 36, CC-FS CO-COOL 120, CC-FS A-COOL 220), one each of the following COMBICLICK non-woven discs (CC-VRH A 240 F, CC-VRH A 180 M, CC-VRH A 100 G, CC-VRW A 280, CC-VRW A 180, CC-VRW A 100, CC-PNER W SiC F), one each of universal polishing paste, COMBICLICK felt disc CC-FR and COMBICLICK backing pad.

Special features:

- The innovative quick-mounting system ensures convenient handling and rapid tool changing.
- Getting to know and testing the comprehensive system.
- Coordinated selection of the most common versions.

D [mm]	Thread [mm]		Item no.	Designation	Price/unit EUR
115	5/8-11	1	49350073	CC-SET 115 5/8-11	-
	M14	1	49350071	CC-SET 115 M14	-
125	5/8-11	1	49350074	CC-SET 125 5/8-11	-
	M14	1	49350072	CC-SET 125 M14	-



The quick way to find the perfect tool

			Abrasive ▶								
Material group ▼			Aluminium oxide A	Zircon Z	Ceramic oxide grain CO	VICTOGRAIN	Aluminium oxide A-COOL	Zircon Z-COOL	Ceramic oxide grain CO-COOL	Ceramic oxide grain CO-ALU	VICTOGRAIN-COOL
Steel, cast steel	Non-hardened, non-heat-treated steels	Construction steels, carbon steels, tool steels, non-alloyed steels, cast steel	•	○	•	•					○
	Hardened, heat-treated steels	Tool steels, tempering steels, alloyed steels, cast steel	○	•	•	•					○
Stainless steel (INOX)	Rust and acid-resistant steels	Austenitic and ferritic stainless steels		○		○	•	•	•		•
Non-ferrous metals	Soft non-ferrous metals, non-ferrous metals	Soft aluminium alloys	○				•	○	○	○	
		Brass, copper, zinc	•	○	○					○	
	Hard non-ferrous metals	Hard aluminium alloys	•	○	○					○	
		Bronze, titanium		○	○	○		•	•		•
	High-temperature-resistant materials	Nickel-based and cobalt-based alloys		○	○	○		•	•	○	•
Cast iron	Grey cast iron, white cast iron	Cast iron with flake graphite EN-GJL (GG), with nodular graphite/nodular cast iron EN-GJS (GGG), white annealed cast iron EN-GJMW (GTW), black annealed cast iron EN-GJMB (GTS)	•	○	•						
Plastics, other materials		Fibre-reinforced plastics, thermoplastics, wood, chipboard, paint	•								

• = highly suitable ○ = suitable

Safety notes

- The maximum permitted peripheral speed is 80 m/s.
- For safety reasons, the maximum permitted rotational speed indicated must never be exceeded.



Wear eye protection!



Wear hearing protection!



Wear gloves!



Wear a dust mask!



Use backing pad!



Follow the safety instructions!



Not permitted for wet grinding!



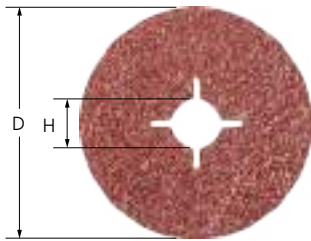

Aluminium oxide A version

For general grinding work from coarse to fine grinding in industry and professional trades.



Special features:

- High economic efficiency thanks to long tool life and very high stock removal rate.
- Consistent surface finish thanks to high-quality abrasives. Highly flexible, enabling optimal adjustment to the contour.
- Please order necessary backing pad separately.

D [mm]	H [mm]	Abrasive	Grit size	Max. RPM		Item no.	Designation	Price/unit EUR
100	16	A	16	15,300	25	69401127	FS 100-16 A 16	-
			24	15,300	25	69401016	FS 100-16 A 24	-
			36	15,300	25	69401015	FS 100-16 A 36	-
			50	15,300	25	69401065	FS 100-16 A 50	-
			60	15,300	25	69401023	FS 100-16 A 60	-
			80	15,300	25	69401024	FS 100-16 A 80	-
			100	15,300	25	69401019	FS 100-16 A 100	-
			120	15,300	25	69401067	FS 100-16 A 120	-
115	22	A	16	13,300	25	64101111	FS 115-22 A 16	-
			24	13,300	25	64102111	FS 115-22 A 24	-
			36	13,300	25	64103111	FS 115-22 A 36	-
			50	13,300	25	64105111	FS 115-22 A 50	-
			60	13,300	25	64106111	FS 115-22 A 60	-
			80	13,300	25	64108111	FS 115-22 A 80	-
			100	13,300	25	64110111	FS 115-22 A 100	-
			120	13,300	25	64112111	FS 115-22 A 120	-
125	22	A	16	12,200	25	64101125	FS 125-22 A 16	-
			24	12,200	25	64102125	FS 125-22 A 24	-
			36	12,200	25	64103125	FS 125-22 A 36	-
			50	12,200	25	64105125	FS 125-22 A 50	-
			60	12,200	25	64106125	FS 125-22 A 60	-
			80	12,200	25	64108125	FS 125-22 A 80	-
			100	12,200	25	64110125	FS 125-22 A 100	-
			120	12,200	25	64112125	FS 125-22 A 120	-
150	22	A	36	10,200	25	64103155	FS 150-22 A 36	-
			60	10,200	25	64106155	FS 150-22 A 60	-
			80	10,200	25	64108155	FS 150-22 A 80	-
180	22	A	16	8,500	25	64101175	FS 180-22 A 16	-
			24	8,500	25	64102175	FS 180-22 A 24	-
			36	8,500	25	64103175	FS 180-22 A 36	-
			50	8,500	25	64105175	FS 180-22 A 50	-
			60	8,500	25	64106175	FS 180-22 A 60	-
			80	8,500	25	64108175	FS 180-22 A 80	-
			100	8,500	25	64110175	FS 180-22 A 100	-
			120	8,500	25	64112175	FS 180-22 A 120	-

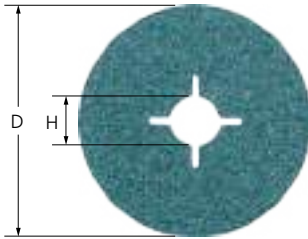

Zirconia alumina Z version

For coarse grinding work with a high stock removal rate and a long tool life.

Special features:

- High economic efficiency thanks to long tool life and very high stock removal rate.
- Consistent surface finish thanks to high-quality abrasives. Highly flexible, enabling optimal adjustment to the contour.

- Please order necessary backing pad separately.

D [mm]	H [mm]	Abrasive	Grit size	Max. RPM		Item no.	Designation	Price/unit EUR
100	16	Z	24	15,300	25	69401548	FS 100-16 Z 24	-
			36	15,300	25	69401549	FS 100-16 Z 36	-
			50	15,300	25	69401550	FS 100-16 Z 50	-
			60	15,300	25	69401495	FS 100-16 Z 60	-
			80	15,300	25	69401551	FS 100-16 Z 80	-
			100	15,300	25	69401496	FS 100-16 Z 100	-
			120	15,300	25	69401552	FS 100-16 Z 120	-
115	22	Z	24	13,300	25	64202111	FS 115-22 Z 24	-
			36	13,300	25	64203111	FS 115-22 Z 36	-
			50	13,300	25	64205111	FS 115-22 Z 50	-
			60	13,300	25	64206111	FS 115-22 Z 60	-
			80	13,300	25	64208111	FS 115-22 Z 80	-
			100	13,300	25	64210111	FS 115-22 Z 100	-
			120	13,300	25	64212111	FS 115-22 Z 120	-
125	22	Z	24	12,200	25	64202125	FS 125-22 Z 24	-
			36	12,200	25	64203125	FS 125-22 Z 36	-
			50	12,200	25	64205125	FS 125-22 Z 50	-
			60	12,200	25	64206125	FS 125-22 Z 60	-
			80	12,200	25	64208125	FS 125-22 Z 80	-
			100	12,200	25	64210125	FS 125-22 Z 100	-
			120	12,200	25	64212125	FS 125-22 Z 120	-
180	22	Z	24	8,500	25	64202175	FS 180-22 Z 24	-
			36	8,500	25	64203175	FS 180-22 Z 36	-
			50	8,500	25	64205175	FS 180-22 Z 50	-
			60	8,500	25	64206175	FS 180-22 Z 60	-
			80	8,500	25	64208175	FS 180-22 Z 80	-
			100	8,500	25	64210175	FS 180-22 Z 100	-
			120	8,500	25	64212175	FS 180-22 Z 120	-

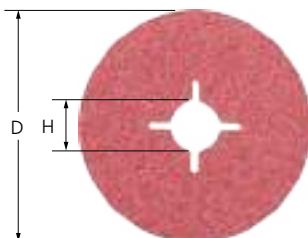

Ceramic oxide grain CO version

For aggressive grinding with maximum stock removal rate and very long tool life. Consistently high performance due to self-sharpening ceramic oxide grain. The ceramic oxide grain is specifically designed for work on hard materials and layers.

Special features:

- High economic efficiency thanks to long tool life and very high stock removal rate.

- Consistent surface finish thanks to high-quality abrasives. Highly flexible, enabling optimal adjustment to the contour.
- Please order necessary backing pad separately.

D [mm]	H [mm]	Abrasive	Grit size	Max. RPM		Item no.	Designation	Price/unit EUR
115	22	CO	24	13,300	25	64152111	FS 115-22 CO 24	-
			36	13,300	25	64153111	FS 115-22 CO 36	-
			50	13,300	25	64155111	FS 115-22 CO 50	-
			60	13,300	25	64156111	FS 115-22 CO 60	-
			80	13,300	25	64158111	FS 115-22 CO 80	-
			120	13,300	25	64162111	FS 115-22 CO 120	-

Continued on next page



D [mm]	H [mm]	Abrasive	Grit size	Max. RPM		Item no.	Designation	Price/unit EUR
125	22	CO	24	12,200	25	64152125	FS 125-22 CO 24	-
			36	12,200	25	64153125	FS 125-22 CO 36	-
			50	12,200	25	64155125	FS 125-22 CO 50	-
			60	12,200	25	64156125	FS 125-22 CO 60	-
			80	12,200	25	64158125	FS 125-22 CO 80	-
			120	12,200	25	64162125	FS 125-22 CO 120	-
180	22	CO	24	8,500	25	64152175	FS 180-22 CO 24	-
			36	8,500	25	64153175	FS 180-22 CO 36	-
			60	8,500	25	64156175	FS 180-22 CO 60	-
			80	8,500	25	64158175	FS 180-22 CO 80	-
			120	8,500	25	64162175	FS 180-22 CO 120	-

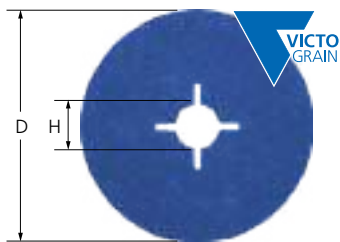

VICTOGRAIN version

For maximum aggressive grinding with an extremely long tool life and the ultimate stock removal rate on steel and hard materials. The ultimate, consistently high performance.



Special features:

- High economic efficiency thanks to long tool life and very high stock removal rate.
- Consistent surface finish thanks to high-quality abrasives. Highly flexible, enabling optimal adjustment to the contour.
- Please order necessary backing pad separately.

D [mm]	H [mm]	Abrasive	Grit size	Max. RPM		Item no.	Designation	Price/unit EUR
100	16	VICTOGRAIN	36	15,300	25	64279011	FS 100-16 VICTOGRAIN 36	-
			60	15,300	25	64279019	FS 100-16 VICTOGRAIN 60	-
			80	15,300	25	64279020	FS 100-16 VICTOGRAIN 80	-
115	22	VICTOGRAIN	36	13,300	25	64279012	FS 115-22 VICTOGRAIN 36	-
			60	13,300	25	64279021	FS 115-22 VICTOGRAIN 60	-
						64279022	FS 115-22 VICTOGRAIN 80	-
125	22	VICTOGRAIN	36	12,200	25	64279013	FS 125-22 VICTOGRAIN 36	-
			60	12,200	25	64279023	FS 125-22 VICTOGRAIN 60	-
			80	12,200	25	64279024	FS 125-22 VICTOGRAIN 80	-
150	22	VICTOGRAIN	36	10,200	25	64279018	FS 150-22 VICTOGRAIN 36	-
			60	10,200	25	64279025	FS 150-22 VICTOGRAIN 60	-
			80	10,200	25	64279026	FS 150-22 VICTOGRAIN 80	-
180	22	VICTOGRAIN	36	8,500	25	64279014	FS 180-22 VICTOGRAIN 36	-
			60	8,500	25	64279027	FS 180-22 VICTOGRAIN 60	-
			80	8,500	25	64279028	FS 180-22 VICTOGRAIN 80	-

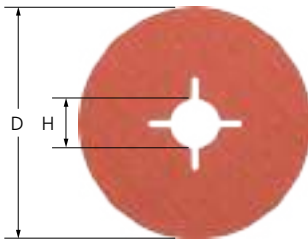

Aluminium oxide A-COOL version

For general grinding work from fine to very fine grinding on materials which do not conduct heat well, e.g. stainless steel (INOX). Active grinding additives substantially improve the stock removal rate, prevent clogging and result in cooler grinding.



Special features:

- High economic efficiency thanks to long tool life and very high stock removal rate.
- Consistent surface finish thanks to high-quality abrasives. Highly flexible, enabling optimal adjustment to the contour.
- Please order necessary backing pad separately.

D [mm]	H [mm]	Abrasive	Grit size	Max. RPM		Item no.	Designation	Price/unit EUR
115	22	A-COOL	50	13,300	25	64125111	FS 115-22 A-COOL 50	-
			60	13,300	25	64126111	FS 115-22 A-COOL 60	-
			80	13,300	25	64128111	FS 115-22 A-COOL 80	-
			100	13,300	25	64130111	FS 115-22 A-COOL 100	-
			120	13,300	25	64132111	FS 115-22 A-COOL 120	-
			150	13,300	25	64135111	FS 115-22 A-COOL 150	-
			180	13,300	25	64138111	FS 115-22 A-COOL 180	-
			220	13,300	25	64142111	FS 115-22 A-COOL 220	-
125	22	A-COOL	60	12,200	25	64126125	FS 125-22 A-COOL 60	-
			80	12,200	25	64128125	FS 125-22 A-COOL 80	-
			100	12,200	25	64130125	FS 125-22 A-COOL 100	-
			120	12,200	25	64132125	FS 125-22 A-COOL 120	-
			150	12,200	25	64135125	FS 125-22 A-COOL 150	-
			180	12,200	25	64138125	FS 125-22 A-COOL 180	-
			220	12,200	25	64142125	FS 125-22 A-COOL 220	-
180	22	A-COOL	50	8,500	25	64125175	FS 180-22 A-COOL 50	-
			60	8,500	25	64126175	FS 180-22 A-COOL 60	-
			80	8,500	25	64128175	FS 180-22 A-COOL 80	-
			100	8,500	25	64130175	FS 180-22 A-COOL 100	-
			120	8,500	25	64132175	FS 180-22 A-COOL 120	-
			150	8,500	25	64135175	FS 180-22 A-COOL 150	-
			180	8,500	25	64138175	FS 180-22 A-COOL 180	-
			220	8,500	25	64142175	FS 180-22 A-COOL 220	-

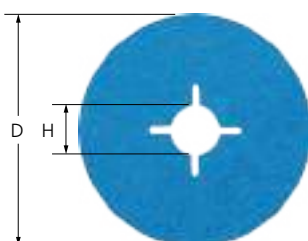

Zirconia alumina Z-COOL version

For coarse grinding work with a high stock removal rate and cool grinding. Active grinding additives substantially improve the stock removal rate, prevent clogging and result in cooler grinding.

Special features:

- High economic efficiency thanks to long tool life and very high stock removal rate.
- Consistent surface finish thanks to high-quality abrasives. Highly flexible, enabling optimal adjustment to the contour.
- Please order necessary backing pad separately.

D [mm]	H [mm]	Abrasive	Grit size	Max. RPM		Item no.	Designation	Price/unit EUR
115	22	Z-COOL	36	13,300	25	64273111	FS 115-22 Z-COOL 36	-
			60	13,300	25	64276111	FS 115-22 Z-COOL 60	-
125	22	Z-COOL	36	12,200	25	64273125	FS 125-22 Z-COOL 36	-
			60	12,200	25	64276125	FS 125-22 Z-COOL 60	-
			80	12,200	25	64278125	FS 125-22 Z-COOL 80	-



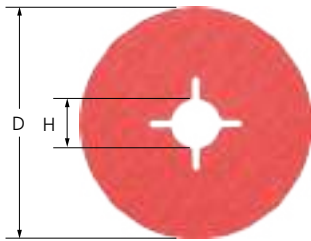

Ceramic oxide grain CO-COOL version

Consistently high performance and aggressive grinding due to self-sharpening ceramic oxide grain. Active grinding additives improve the stock removal rate, prevent clogging and result in cooler grinding on hard materials which do not conduct heat well.



Special features:

- High economic efficiency thanks to long tool life and very high stock removal rate.
- Consistent surface finish thanks to high-quality abrasives. Highly flexible, enabling optimal adjustment to the contour.
- Please order necessary backing pad separately.

D [mm]	H [mm]	Abrasive	Grit size	Max. RPM		Item no.	Designation	Price/unit EUR
100	16	CO-COOL	24	15,300	25	69401583	FS 100-16 CO-COOL 24	-
			36	15,300	25	69401553	FS 100-16 CO-COOL 36	-
			50	15,300	25	69401554	FS 100-16 CO-COOL 50	-
			60	15,300	25	69401555	FS 100-16 CO-COOL 60	-
			80	15,300	25	69401556	FS 100-16 CO-COOL 80	-
			120	15,300	25	69401584	FS 100-16 CO-COOL 120	-
115	22	CO-COOL	24	13,300	25	64172111	FS 115-22 CO-COOL 24	-
			36	13,300	25	64173111	FS 115-22 CO-COOL 36	-
			50	13,300	25	64175111	FS 115-22 CO-COOL 50	-
			60	13,300	25	64176111	FS 115-22 CO-COOL 60	-
			80	13,300	25	64178111	FS 115-22 CO-COOL 80	-
			100	13,300	25	64180111	FS 115-22 CO-COOL 100	-
125	22	CO-COOL	24	12,200	25	64182111	FS 115-22 CO-COOL 120	-
			24	12,200	25	64172125	FS 125-22 CO-COOL 24	-
			36	12,200	25	64173125	FS 125-22 CO-COOL 36	-
			50	12,200	25	64175125	FS 125-22 CO-COOL 50	-
			60	12,200	25	64176125	FS 125-22 CO-COOL 60	-
			80	12,200	25	64178125	FS 125-22 CO-COOL 80	-
180	22	CO-COOL	100	12,200	25	64180125	FS 125-22 CO-COOL 100	-
			120	12,200	25	64182125	FS 125-22 CO-COOL 120	-
			24	8,500	25	64172175	FS 180-22 CO-COOL 24	-
			36	8,500	25	64173175	FS 180-22 CO-COOL 36	-
			50	8,500	25	64175175	FS 180-22 CO-COOL 50	-
			60	8,500	25	64176175	FS 180-22 CO-COOL 60	-
			80	8,500	25	64178175	FS 180-22 CO-COOL 80	-
			100	8,500	25	64180175	FS 180-22 CO-COOL 100	-
			120	8,500	25	64182175	FS 180-22 CO-COOL 120	-

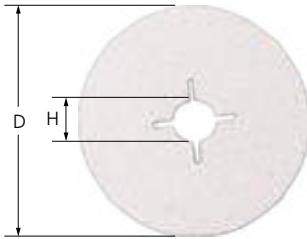

Ceramic oxide grain CO-ALU version

For aggressive grinding with maximum stock removal rate for machining non-ferrous metals. Consistently high performance due to self-sharpening ceramic oxide grain. Adhesion-reducing additives in the coating significantly reduce the chip adhesion and therefore reduce clogging of the fibre discs.



Special features:

- High economic efficiency thanks to long tool life and very high stock removal rate.
- Consistent surface finish thanks to high-quality abrasives. Highly flexible, enabling optimal adjustment to the contour.
- Please order necessary backing pad separately.

D [mm]	H [mm]	Abrasive	Grit size	Max. RPM		Item no.	Designation	Price/unit EUR
100	16	CO-ALU	36	15,300	25	64281036	FS 100-16 CO-ALU 36	-
			60	15,300	25	64281060	FS 100-16 CO-ALU 60	-
			80	15,300	25	64281080	FS 100-16 CO-ALU 80	-
115	22	CO-ALU	36	13,300	25	64281136	FS 115-22 CO-ALU 36	-
			60	13,300	25	64281160	FS 115-22 CO-ALU 60	-
			80	13,300	25	64281180	FS 115-22 CO-ALU 80	-
125	22	CO-ALU	36	12,200	25	64281236	FS 125-22 CO-ALU 36	-
			60	12,200	25	64281260	FS 125-22 CO-ALU 60	-
			80	12,200	25	64281280	FS 125-22 CO-ALU 80	-
180	22	CO-ALU	36	8,500	25	64281836	FS 180-22 CO-ALU 36	-
			60	8,500	25	64281860	FS 180-22 CO-ALU 60	-
			80	8,500	25	64281880	FS 180-22 CO-ALU 80	-

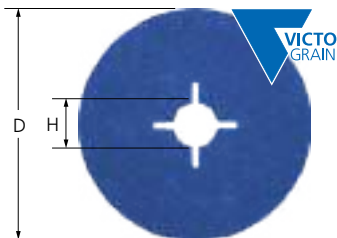

VICTOGRAIN-COOL version

For maximum aggressive grinding with an extremely long tool life, the ultimate stock removal rate and consistently high performance on steel and hard materials which do not conduct heat well. Active grinding additives in the coating prevent clogging and result in cooler grinding.

Special features:

- High economic efficiency thanks to long tool life and very high stock removal rate.
- Consistent surface finish thanks to high-quality abrasives. Highly flexible, enabling optimal adjustment to the contour.
- Please order necessary backing pad separately.

D [mm]	H [mm]	Abrasive	Grit size	Max. RPM		Item no.	Designation	Price/unit EUR
100	16	VICTOGRAIN-COOL	36	15,300	25	64279001	FS 100-16 VICTOGRAIN-COOL 36	-
			60	15,300	25	64279029	FS 100-16 VICTOGRAIN-COOL 60	-
			80	15,300	25	64279030	FS 100-16 VICTOGRAIN-COOL 80	-
115	22	VICTOGRAIN-COOL	36	13,300	25	64279002	FS 115-22 VICTOGRAIN-COOL 36	-
			60	13,300	25	64279031	FS 115-22 VICTOGRAIN-COOL 60	-
			80	13,300	25	64279032	FS 115-22 VICTOGRAIN-COOL 80	-
125	22	VICTOGRAIN-COOL	36	12,200	25	64279003	FS 125-22 VICTOGRAIN-COOL 36	-
			60	12,200	25	64279033	FS 125-22 VICTOGRAIN-COOL 60	-
			80	12,200	25	64279034	FS 125-22 VICTOGRAIN-COOL 80	-
150	22	VICTOGRAIN-COOL	36	10,200	25	69401655	FS 150-22 VICTOGRAIN-COOL 36	-
			60	10,200	25	64279035	FS 150-22 VICTOGRAIN-COOL 60	-
			80	10,200	25	64279036	FS 150-22 VICTOGRAIN-COOL 80	-
180	22	VICTOGRAIN-COOL	36	8,500	25	64279004	FS 180-22 VICTOGRAIN-COOL 36	-
			60	8,500	25	64279037	FS 180-22 VICTOGRAIN-COOL 60	-
			80	8,500	25	64279038	FS 180-22 VICTOGRAIN-COOL 80	-





GT type

Backing pad for fibre discs for optimum adaptation to contours thanks to high flexibility. Complies with ISO 15636.

Special features:

- For use with fibre discs on commercially available angle grinders.

- Contains clamping nuts.

Suitable for tool diameter [mm]	Thread	Suitable for machine types	Max. RPM		Item no.	Designation	Price/unit EUR
100	M10	Angle grinders 100, spindle M10	15,300	1	44890015	GT 100 MF M10	-
115	M10	Angle grinders 115, spindle M10	13,300	1	44890020	GT 115 MF M10	-
	M14	Angle grinders 115, spindle M14	13,300	1	44890030	GT 115 MF M14	-
125	M14	Angle grinder 125, spindle M14	12,200	1	44890040	GT 125 MF M14	-
150	M14	Angle grinders 150, spindle M14	10,200	1	44890050	GT 150 MF M14	-
180	M14	Angle grinders 180, spindle M14	8,500	1	44890060	GT 180 MF M14	-



H-GT type

High-performance backing pad for fibre discs with a long tool life thanks to abrasion-resistant, glass-fibre-reinforced plastic. Impresses with particularly cool grinding due to radially arranged cooling fins, and high fibre-disc stock removal rate due to sturdy, rigid design.

Special features:

- For use with fibre discs on commercially available angle grinders.

- Contains clamping nuts.

Suitable for tool diameter [mm]	Thread	Suitable for machine types	Max. RPM		Item no.	Designation	Price/unit EUR
115	M14	Angle grinders 115, spindle M14	13,300	1	44890080	H-GT 115 MF M14	-
125	M14	Angle grinder 125, spindle M14	12,200	1	44890090	H-GT 125 MF M14	-
180	M14	Angle grinders 180, spindle M14	8,500	1	44890100	H-GT 180 MF M14	-



HT-GT type

Flexible and extremely temperature-resistant backing pad for fibre discs with a long tool life due to the highly temperature-resistant material. Enables high-precision work thanks to high flexibility. Complies with ISO 15636.

Special features:

- For use with fibre discs on commercially available angle grinders.

- Contains clamping nuts.

Suitable for tool diameter [mm]	Thread	Suitable for machine types	Max. RPM		Item no.	Designation	Price/unit EUR
115	M14	Angle grinders 115, spindle M14	13,300	1	44890200	HT-GT 115 MF M14	-
125	M14	Angle grinder 125, spindle M14	12,200	1	44890210	HT-GT 125 MF M14	-
180	M14	Angle grinders 180, spindle M14	8,500	1	44890220	HT-GT 180 MF M14	-



FL-GT, clamping nuts for backing pads GT

Accessories for GT-variant backing pads.

Special features:

- Matching centre hole distances for standard commercial face pin spanners.

Thread	Suitable for machine types [mm]		Item no.	Designation	Price/unit EUR
M10	Angle grinders 100, spindle M10	1	44890110	FL-GT 100 M10	-
M14	Angle grinder 80-115, spindle M14	1	44890120	FL-GT 80-115 M14	-
	Angle grinder 125, spindle M14	1	44890130	FL-GT 125 M14	-
	Angle grinder 150-230, v M14	1	44890140	FL-GT 150-230 M14	-

Stand

Stand for fibre discs

Stand made from impact-resistant plastic for the secure storage of fibre discs exactly in line with their shape. The holder can be stood upright, as well as bolted to walls.

Special features:

- Perfect storage of fibre grinding discs.
- With quick adjustment device and attachment holes on the base.
- Suitable for fibre disc diameters 100 mm to 230 mm.



	Item no.	Designation	Price/unit EUR
1	44858015	STORAGE FS-S 100-230	-



Self-adhesive discs

General information



Safety notes

- The maximum permitted peripheral speed is 32 m/s.
- For safety reasons, the maximum permitted rotational speed indicated must never be exceeded.
- Place the self-adhesive discs centrally on the holder.



Wear eye protection!



Wear hearing protection!



Wear gloves!



Wear a dust mask!



Use backing pad!



Follow the safety instructions!



Not permitted for wet grinding!



4

Self-adhesive discs KR



Aluminium oxide A version

These self-adhesive discs are suitable for general coarse to fine grinding work on larger surfaces in industry and professional trades.



Special features:

- Quick tool changes thanks to self-adhesive system.
- Highly flexible, enabling optimal adjustment to the contour.
- With the self-adhesive disc holder, can be used on commercially available speed-adjustable or slow-running angle grinders with M14 mounting.

D ₁ [mm]	Abrasive	Grit size	Opt. RPM	Max. RPM		Item no.	Designation	Price/unit EUR
115	A	40	5,000	5,300	50	42871104	KR 115 A 40	-
		60	5,000	5,300	50	42871106	KR 115 A 60	-
		80	5,000	5,300	50	42871108	KR 115 A 80	-
		120	5,000	5,300	50	42871112	KR 115 A 120	-
		150	5,000	5,300	50	42871115	KR 115 A 150	-
		180	5,000	5,300	50	42871118	KR 115 A 180	-
125	A	40	4,600	4,850	50	42871204	KR 125 A 40	-
		60	4,600	4,850	50	42871206	KR 125 A 60	-
		80	4,600	4,850	50	42871208	KR 125 A 80	-
		120	4,600	4,850	50	42871212	KR 125 A 120	-
		150	4,600	4,850	50	42871215	KR 125 A 150	-
		180	4,600	4,850	50	42871218	KR 125 A 180	-



Aluminium oxide A compact grain version

The wide range of different grains makes this range exceptionally well-suited to fine and very fine grinding, and for step-by-step preparations for polishing larger surfaces.



Special features:

- Quick tool changes thanks to self-adhesive system. Highly flexible, enabling optimal adjustment to the contour.
- Very long tool life and consistent surface roughness over the entire lifespan thanks to self-sharpening compact grain.

D ₁ [mm]	Abrasive	Grit size	Opt. RPM	Max. RPM		Item no.	Designation	Price/unit EUR
115	A-CK	120	5,000	5,300	50	42870004	KR 115 A 120 CK	-
		180	5,000	5,300	50	42870006	KR 115 A 180 CK	-
		240	5,000	5,300	50	42870008	KR 115 A 240 CK	-
		320	5,000	5,300	50	42870010	KR 115 A 320 CK	-
		400	5,000	5,300	50	42870012	KR 115 A 400 CK	-
		600	5,000	5,300	50	42870014	KR 115 A 600 CK	-
		800	5,000	5,300	50	42870016	KR 115 A 800 CK	-
		1000	5,000	5,300	50	42870018	KR 115 A 1000 CK	-
125	A-CK	1200	5,000	5,300	50	42870020	KR 115 A 1200 CK	-
		120	4,600	4,850	50	42870104	KR 125 A 120 CK	-
		180	4,600	4,850	50	42870106	KR 125 A 180 CK	-
		240	4,600	4,850	50	42870108	KR 125 A 240 CK	-
		320	4,600	4,850	50	42870110	KR 125 A 320 CK	-
		400	4,600	4,850	50	42870112	KR 125 A 400 CK	-
		600	4,600	4,850	50	42870114	KR 125 A 600 CK	-
		800	4,600	4,850	50	42870116	KR 125 A 800 CK	-
		1000	4,600	4,850	50	42870118	KR 125 A 1000 CK	-
		1200	4,600	4,850	50	42870120	KR 125 A 1200 CK	-



Self-adhesive disc holders KRH



KRH type

Flexible arbor for using self-adhesive discs on speed-adjustable or slow-running angle grinders with M14 mounting.

Special features:

- Quick tool changes thanks to self-adhesive system.

D [mm]	Thread	Hardness	Max. RPM		Item no.	Designation	Price/unit EUR
115	M14	soft	5,300	1	42710155	KRH-S 115 M14	-
125	M14	soft	4,850	1	42710255	KRH-S 125 M14	-
115	M14	medium	5,300	1	42710154	KRH 115 M14	-
125	M14	medium	4,850	1	42710254	KRH 125 M14	-

Self-adhesive abrasive discs

General information



Safety notes

- The maximum permitted peripheral speed is 20 m/s.
- For safety reasons, the maximum permitted rotational speed indicated must never be exceeded.



Wear eye protection!



Wear hearing protection!



Wear gloves!



Wear a dust mask!



Follow the safety instructions!



Self-adhesive abrasive discs PSA

4



Aluminium oxide A version

Self-adhesive abrasive discs specifically for tool and mould-making. For heavily contoured, delicate components. Different surface quality levels from coarse to very fine can be successfully achieved.



Special features:

- Highly flexible, enabling optimal adjustment to the contour.
- Quick and easy tool change. Disc securely held on the holder thanks to high-quality adhesive connections.
- Please order abrasive disc holder separately.

D ₁ [mm]	Abrasive	Grit size	Opt. RPM	Max. RPM		Item no.	Designation	Price/unit EUR
12	A	60	16,000	31,800	100	42832006	PSA 12 A 60	-
		80	16,000	31,800	100	42832008	PSA 12 A 80	-
		120	16,000	31,800	100	42832012	PSA 12 A 120	-
		180	16,000	31,800	100	42832018	PSA 12 A 180	-
		240	16,000	31,800	100	42832024	PSA 12 A 240	-
		320	16,000	31,800	100	42832032	PSA 12 A 320	-
		400	16,000	31,800	100	42832040	PSA 12 A 400	-
20	A	60	10,000	19,100	100	42832106	PSA 20 A 60	-
		80	10,000	19,100	100	42832108	PSA 20 A 80	-
		120	10,000	19,100	100	42832112	PSA 20 A 120	-
		180	10,000	19,100	100	42832118	PSA 20 A 180	-
		240	10,000	19,100	100	42832124	PSA 20 A 240	-
		320	10,000	19,100	100	42832132	PSA 20 A 320	-
		400	10,000	19,100	100	42832140	PSA 20 A 400	-
30	A	60	6,500	12,700	100	42832206	PSA 30 A 60	-
		80	6,500	12,700	100	42832208	PSA 30 A 80	-
		120	6,500	12,700	100	42832212	PSA 30 A 120	-
		180	6,500	12,700	100	42832218	PSA 30 A 180	-
		240	6,500	12,700	100	42832224	PSA 30 A 240	-
		320	6,500	12,700	100	42832232	PSA 30 A 320	-
		400	6,500	12,700	100	42832240	PSA 30 A 400	-

Continued on next page

D ₁ [mm]	Abrasive	Grit size	Opt. RPM	Max. RPM		Item no.	Designation	Price/unit EUR
30	A	600	6,500	12,700	100	42832260	PSA 30 A 600	-
50	A	60	4,000	7,650	100	42832306	PSA 50 A 60	-
		80	4,000	7,650	100	42832308	PSA 50 A 80	-
		120	4,000	7,650	100	42832312	PSA 50 A 120	-
		180	4,000	7,650	100	42832318	PSA 50 A 180	-
		240	4,000	7,650	100	42832324	PSA 50 A 240	-
		320	4,000	7,650	100	42832332	PSA 50 A 320	-
		400	4,000	7,650	100	42832340	PSA 50 A 400	-
		600	4,000	7,650	100	42832360	PSA 50 A 600	-

Abrasive disc holder PSA-H



PSA-H version

Flexible abrasive disc holder for using self-adhesive abrasive discs, specifically for tool and mould construction.

Special features:

- Highly flexible, enabling optimal adjustment to the contour.
- Quick and easy tool change.
- Secure hold of the disc on the holder thanks to high-quality adhesive connections.

D [mm]	S [mm]	L [mm]	Max. RPM	Suitable for		Item no.	Designation	Price/unit EUR
Shank diameter of 2.35 mm								
10	2.35	35	31,800	PSA 12	5	42160000	PSA-H 12-2,35	-
18	2.35	35	19,100	PSA 20	5	42160002	PSA-H 20-2,35	-
25	2.35	35	12,700	PSA 30	5	42160004	PSA-H 30-2,35	-
Shank diameter 3 mm								
10	3	35	31,800	PSA 12	5	42160001	PSA-H 12-3	-
18	3	35	19,100	PSA 20	5	42160003	PSA-H 20-3	-
25	3	35	12,700	PSA 30	5	42160005	PSA-H 30-3	-
50	3	35	7,650	PSA 50	5	42160007	PSA-H 50-3	-
Shank diameter 6 mm								
50	6	35	7,650	PSA 50	5	42160006	PSA-H 50-6	-



COMBIDISC clamping system CD and CDR



CD system

Tool side: threaded connection with female thread (metal/plastic).



CDR system

Tool side: threaded connection with male thread (plastic).



The quick way to find the perfect tool

4

Material group ▼			Abrasive ▶	Aluminium oxide A, A-PLUS, A-FLEX, A-CONTOUR, A-FORTE	Aluminium oxide A, compact grain	Zirconia alumina Z	Silicon carbide SiC	Aluminium oxide A-COOL	Ceramic oxide grain CO-COOL	VICTOGRAIN-COOL	Abrasive discs Diamond	POLICLEAN discs	Non-woven discs PNER, VRH, VRW
Steel, cast steel	Non-hardened, non-heat-treated steels	Construction steels, carbon steels, tool steels, non-alloyed steels, cast steel	•		○				•	•		•	•
	Hardened, heat-treated steels	Tool steels, tempering steels, alloyed steels, cast steel	○	•	•				•	•		○	○
Stainless steel (INOX)	Rust and acid-resistant steels	Austenitic and ferritic stainless steels		•	○			•	•	•		•	•
Non-ferrous metals	Soft non-ferrous metals, non-ferrous metals	Soft aluminium alloys	○					•	○			•	•
		Brass, copper, zinc	•		○							•	•
	Hard non-ferrous metals	Hard aluminium alloys	•		○	○						•	•
		Bronze, titanium			○	•			•	•	•	○	•
	High-temperature-resistant materials	Nickel-based and cobalt-based alloys			○			•	•	•	○	•	
Cast iron	Grey cast iron, white cast iron	Cast iron with flake graphite EN-GJL (GG), with nodular graphite/nodular cast iron EN-GJS (GGG), white annealed cast iron EN-GJMW (GTW), black annealed cast iron EN-GJMB (GTS)	•		○							•	•
Plastics, other materials		Fibre-reinforced plastics, thermoplastics, wood, chipboard, paint	•				•				•	•	•

• = highly suitable ○ = suitable

Safety notes

- The maximum permitted peripheral speed is 50 m/s.
- For safety reasons, the maximum permitted rotational speed indicated must never be exceeded.



Wear eye protection!



Wear hearing protection!



Wear gloves!



Wear a dust mask!



Follow the safety instructions!



Mini-POLIFAN CD, CDR

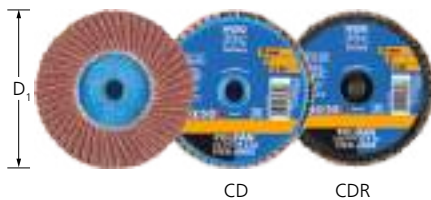

Aluminium oxide A version

For general coarse grinding work with high stock removal rates. Ideal for dressing weld seams in hard-to-reach places. Longer tool life and higher stock removal rate when compared to abrasive discs.



Special features:

- High economic efficiency as tool can be changed quickly. Very comfortable due to ease of use and low-vibration working.
- No disruptions in use due to adhesion, slipping or coming loose.
- Please order backing pad or arbor BO PFF separately.



D ₁ [mm]	Abrasive	Grit size	Suitable arbors	Opt. RPM		Item no.	Designation	Price/unit EUR
CD system								
50	A	40	SBH 20-50, BO PFF 50	12,000 – 14,000	10	42719104	CD PFF 50 A 40	-
		60	SBH 20-50, BO PFF 50	12,000 – 14,000	10	42719106	CD PFF 50 A 60	-
		80	SBH 20-50, BO PFF 50	12,000 – 14,000	10	42719108	CD PFF 50 A 80	-
		120	SBH 20-50, BO PFF 50	12,000 – 14,000	10	42719112	CD PFF 50 A 120	-
75	A	40	SBH 75, BO PFF 75	8,000 – 10,000	10	42719204	CD PFF 75 A 40	-
		60	SBH 75, BO PFF 75	8,000 – 10,000	10	42719206	CD PFF 75 A 60	-
		80	SBH 75, BO PFF 75	8,000 – 10,000	10	42719208	CD PFF 75 A 80	-
		120	SBH 75, BO PFF 75	8,000 – 10,000	10	42719212	CD PFF 75 A 120	-
CDR system								
50	A	40	SBHR 20-75	12,000 – 14,000	10	47202527	CDR PFF 50 A 40	-
		60	SBHR 20-75	12,000 – 14,000	10	47202528	CDR PFF 50 A 60	-
		80	SBHR 20-75	12,000 – 14,000	10	47202090	CDR PFF 50 A 80	-
		120	SBHR 20-75	12,000 – 14,000	10	47202529	CDR PFF 50 A 120	-
75	A	40	SBHR 20-75	8,000 – 10,000	10	47202530	CDR PFF 75 A 40	-
		60	SBHR 20-75	8,000 – 10,000	10	47202531	CDR PFF 75 A 60	-
		80	SBHR 20-75	8,000 – 10,000	10	47202091	CDR PFF 75 A 80	-
		120	SBHR 20-75	8,000 – 10,000	10	47202532	CDR PFF 75 A 120	-

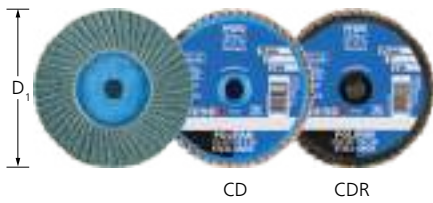



Zirconia alumina Z version

For coarse grinding work with a high stock removal rate and a long tool life.



Special features:

- High economic efficiency as tool can be changed quickly. Very comfortable due to ease of use and low-vibration working.
- No disruptions in use due to adhesion, slipping or coming loose.
- Please order backing pad or arbor BO PFF separately.

D ₁ [mm]	Abrasive	Grit size	Suitable arbors	Opt. RPM		Item no.	Designation	Price/unit EUR
CD system 								
50	Z	40	SBH 20-50, BO PFF 50	12,000 – 14,000	10	42719504	CD PFF 50 Z 40	-
		60	SBH 20-50, BO PFF 50	12,000 – 14,000	10	42719506	CD PFF 50 Z 60	-
		80	SBH 20-50, BO PFF 50	12,000 – 14,000	10	42719508	CD PFF 50 Z 80	-
		120	SBH 20-50, BO PFF 50	12,000 – 14,000	10	42719512	CD PFF 50 Z 120	-
75	Z	40	SBH 75, BO PFF 75	8,000 – 10,000	10	42719704	CD PFF 75 Z 40	-
		60	SBH 75, BO PFF 75	8,000 – 10,000	10	42719706	CD PFF 75 Z 60	-
		80	SBH 75, BO PFF 75	8,000 – 10,000	10	42719708	CD PFF 75 Z 80	-
		120	SBH 75, BO PFF 75	8,000 – 10,000	10	42719712	CD PFF 75 Z 120	-
CDR system 								
50	Z	40	SBHR 20-75	12,000 – 14,000	10	47202125	CDR PFF 50 Z 40	-
		60	SBHR 20-75	12,000 – 14,000	10	47202126	CDR PFF 50 Z 60	-
		80	SBHR 20-75	12,000 – 14,000	10	47202533	CDR PFF 50 Z 80	-
		120	SBHR 20-75	12,000 – 14,000	10	47202534	CDR PFF 50 Z 120	-
75	Z	40	SBHR 20-75	8,000 – 10,000	10	47202101	CDR PFF 75 Z 40	-
		60	SBHR 20-75	8,000 – 10,000	10	47202535	CDR PFF 75 Z 60	-
		80	SBHR 20-75	8,000 – 10,000	10	47202536	CDR PFF 75 Z 80	-
		120	SBHR 20-75	8,000 – 10,000	10	47202092	CDR PFF 75 Z 120	-

Mini-POLIFAN arbor

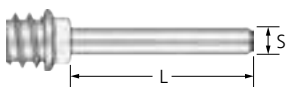

BO PFF

Matching arbors for COMBIDISC Mini-POLIFAN.

S [mm]	L [mm]	Matching tool		Item no.	Designation	Price/unit EUR
6	40	CD PFF 50	1	42700050	BO PFF 50	-
		CD PFF 75	1	42700075	BO PFF 75	-

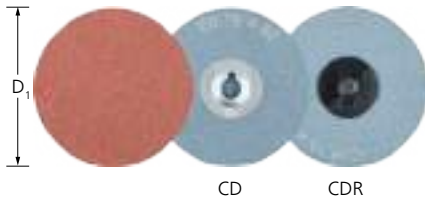



Aluminium oxide A version

For general coarse to fine grinding applications in industry and professional trades.



Special features:

- High economic efficiency as tool can be changed quickly. Very comfortable due to ease of use and low-vibration working.
- No disruptions in use due to adhesion, slipping or coming loose.
- Please order necessary backing pad separately.

D ₁ [mm]	Abrasive	Grit size	Opt. RPM		Item no.	Designation	Price/unit EUR
CD system 							
20	A	60	20,000 – 35,000	100	42750206	CD 20 A 60	-
		80	20,000 – 35,000	100	42750208	CD 20 A 80	-
		120	20,000 – 35,000	100	42750212	CD 20 A 120	-
		180	20,000 – 35,000	100	42750218	CD 20 A 180	-
		320	20,000 – 35,000	100	42750232	CD 20 A 320	-
25	A	60	15,000 – 26,000	100	42750306	CD 25 A 60	-
		80	15,000 – 26,000	100	42750308	CD 25 A 80	-
		120	15,000 – 26,000	100	42750312	CD 25 A 120	-
		180	15,000 – 26,000	100	42750318	CD 25 A 180	-
		320	15,000 – 26,000	100	42750332	CD 25 A 320	-
38	A	36	10,000 – 16,000	100	42750403	CD 38 A 36	-
		60	10,000 – 16,000	100	42750406	CD 38 A 60	-
		80	10,000 – 16,000	100	42750408	CD 38 A 80	-
		120	10,000 – 16,000	100	42750412	CD 38 A 120	-
		180	10,000 – 16,000	100	42750418	CD 38 A 180	-
		320	10,000 – 16,000	100	42750432	CD 38 A 320	-
50	A	36	8,000 – 13,000	100	42750503	CD 50 A 36	-
		60	8,000 – 13,000	100	42750506	CD 50 A 60	-
		80	8,000 – 13,000	100	42750508	CD 50 A 80	-
		120	8,000 – 13,000	100	42750512	CD 50 A 120	-
		180	8,000 – 13,000	100	42750518	CD 50 A 180	-
		320	8,000 – 13,000	100	42750532	CD 50 A 320	-
75	A	36	5,000 – 9,000	50	42750703	CD 75 A 36	-
		60	5,000 – 9,000	50	42750706	CD 75 A 60	-
		80	5,000 – 9,000	50	42750708	CD 75 A 80	-
		120	5,000 – 9,000	50	42750712	CD 75 A 120	-
		180	5,000 – 9,000	50	42750718	CD 75 A 180	-
		320	5,000 – 9,000	50	42750732	CD 75 A 320	-
CDR system 							
20	A	60	20,000 – 35,000	100	42770206	CDR 20 A 60	-
		80	20,000 – 35,000	100	42770208	CDR 20 A 80	-
		120	20,000 – 35,000	100	42770212	CDR 20 A 120	-
		180	20,000 – 35,000	100	42770218	CDR 20 A 180	-
		320	20,000 – 35,000	100	42770232	CDR 20 A 320	-
25	A	60	15,000 – 26,000	100	42770306	CDR 25 A 60	-
		80	15,000 – 26,000	100	42770308	CDR 25 A 80	-
		120	15,000 – 26,000	100	42770312	CDR 25 A 120	-
		180	15,000 – 26,000	100	42770318	CDR 25 A 180	-
		320	15,000 – 26,000	100	42770332	CDR 25 A 320	-
38	A	36	10,000 – 16,000	100	42770403	CDR 38 A 36	-

Continued on next page



D ₁ [mm]	Abrasive	Grit size	Opt. RPM		Item no.	Designation	Price/unit EUR
38	A	60	10,000 – 16,000	100	42770406	CDR 38 A 60	-
		80	10,000 – 16,000	100	42770408	CDR 38 A 80	-
		120	10,000 – 16,000	100	42770412	CDR 38 A 120	-
		180	10,000 – 16,000	100	42770418	CDR 38 A 180	-
		320	10,000 – 16,000	100	42770432	CDR 38 A 320	-
50	A	36	8,000 – 13,000	100	42770503	CDR 50 A 36	-
		60	8,000 – 13,000	100	42770506	CDR 50 A 60	-
		80	8,000 – 13,000	100	42770508	CDR 50 A 80	-
		120	8,000 – 13,000	100	42770512	CDR 50 A 120	-
		180	8,000 – 13,000	100	42770518	CDR 50 A 180	-
75	A	36	5,000 – 9,000	50	42770703	CDR 75 A 36	-
		60	5,000 – 9,000	50	42770706	CDR 75 A 60	-
		80	5,000 – 9,000	50	42770708	CDR 75 A 80	-
		120	5,000 – 9,000	50	42770712	CDR 75 A 120	-
		180	5,000 – 9,000	50	42770718	CDR 75 A 180	-
		320	5,000 – 9,000	50	42770732	CDR 75 A 320	-





Aluminium oxide A-PLUS version

For general applications from coarse to fine grinding. Higher stock removal rate due to sturdy backing material. Particularly for use in edge grinding due to high tear strength.

Special features:

- High economic efficiency as tool can be changed quickly. Very comfortable due to ease of use and low-vibration working.
- No disruptions in use due to adhesion, slipping or coming loose.
- Please order necessary backing pad separately.

D ₁ [mm]	Abrasive	Grit size	Opt. RPM		Item no.	Designation	Price/unit EUR
CD system 							
50	A-PLUS	36 PLUS	8,000 – 13,000	100	42755503	CD 50 A 36 PLUS	-
		60 PLUS	8,000 – 13,000	100	42755506	CD 50 A 60 PLUS	-
		80 PLUS	8,000 – 13,000	100	42755508	CD 50 A 80 PLUS	-
		120 PLUS	8,000 – 13,000	100	42755512	CD 50 A 120 PLUS	-
75	A-PLUS	36 PLUS	5,000 – 9,000	50	42755703	CD 75 A 36 PLUS	-
		60 PLUS	5,000 – 9,000	50	42755706	CD 75 A 60 PLUS	-
		80 PLUS	5,000 – 9,000	50	42755708	CD 75 A 80 PLUS	-
		120 PLUS	5,000 – 9,000	50	42755712	CD 75 A 120 PLUS	-
CDR system 							
50	A-PLUS	36 PLUS	8,000 – 13,000	100	42775503	CDR 50 A 36 PLUS	-
		60 PLUS	8,000 – 13,000	100	42775506	CDR 50 A 60 PLUS	-
		80 PLUS	8,000 – 13,000	100	42775508	CDR 50 A 80 PLUS	-
		120 PLUS	8,000 – 13,000	100	42775512	CDR 50 A 120 PLUS	-
75	A-PLUS	36 PLUS	5,000 – 9,000	50	42775703	CDR 75 A 36 PLUS	-
		60 PLUS	5,000 – 9,000	50	42775706	CDR 75 A 60 PLUS	-
		80 PLUS	5,000 – 9,000	50	42775708	CDR 75 A 80 PLUS	-
		120 PLUS	5,000 – 9,000	50	42775712	CDR 75 A 120 PLUS	-

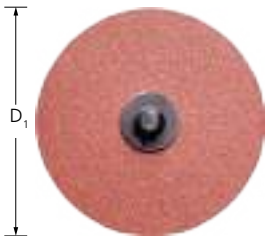



RS aluminium oxide A-PLUS version

Ideal for general applications from coarse to fine grinding on areas that are extremely difficult to access, with a high stock removal rate and long tool life.



Special features:

- Excellent for weld dressing of backwards repair welds, e.g. in cases, slots and grooves on engines.
- The abrasive coating is located on the underside of the tool. This enables convenient and safe backwards working in hard-to-reach areas.
- Ideal for work on welded-on combustor plates. Please order necessary backing pad separately.

D ₁ [mm]	Abrasive	Grit size	Opt. RPM		Item no.	Designation	Price/unit EUR
CDR system							
38	A-PLUS	60 PLUS	10,000 – 16,000	100	42799025	CDR 38 A 60 PLUS RS	-
		80 PLUS	10,000 – 16,000	100	42799026	CDR 38 A 80 PLUS RS	-
		120 PLUS	10,000 – 16,000	100	42799027	CDR 38 A 120 PLUS RS	-
50	A-PLUS	60 PLUS	8,000 – 13,000	100	42799028	CDR 50 A 60 PLUS RS	-
		80 PLUS	8,000 – 13,000	100	42799029	CDR 50 A 80 PLUS RS	-
		120 PLUS	8,000 – 13,000	100	42799030	CDR 50 A 120 PLUS RS	-
75	A-PLUS	60 PLUS	5,000 – 9,000	50	42799031	CDR 75 A 60 PLUS RS	-
		80 PLUS	5,000 – 9,000	50	42799032	CDR 75 A 80 PLUS RS	-
		120 PLUS	5,000 – 9,000	50	42799033	CDR 75 A 120 PLUS RS	-





Aluminium oxide A-FLEX version

Particularly flexible abrasive discs, which are especially suitable for work on contours and concave surfaces, e.g. in tool and mould-making. For achieving seamless transitions in the surface finish.

Special features:

- High economic efficiency as tool can be changed quickly. Very comfortable due to ease of use and low-vibration working.
- No disruptions in use due to adhesion, slipping or coming loose.
- Please order necessary backing pad separately.

D ₁ [mm]	Abrasive	Grit size	Opt. RPM		Item no.	Designation	Price/unit EUR
CD system							
38	A-FLEX	60 FLEX	10,000 – 16,000	100	42757406	CD 38 A 60 FLEX	-
		80 FLEX	10,000 – 16,000	100	42757408	CD 38 A 80 FLEX	-
		120 FLEX	10,000 – 16,000	100	42757412	CD 38 A 120 FLEX	-
50	A-FLEX	60 FLEX	8,000 – 13,000	100	42757506	CD 50 A 60 FLEX	-
		80 FLEX	8,000 – 13,000	100	42757508	CD 50 A 80 FLEX	-
		120 FLEX	8,000 – 13,000	100	42757512	CD 50 A 120 FLEX	-
75	A-FLEX	60 FLEX	5,000 – 9,000	50	42757706	CD 75 A 60 FLEX	-
		80 FLEX	5,000 – 9,000	50	42757708	CD 75 A 80 FLEX	-
		120 FLEX	5,000 – 9,000	50	42757712	CD 75 A 120 FLEX	-
CDR system							
38	A-FLEX	60 FLEX	10,000 – 16,000	100	42777406	CDR 38 A 60 FLEX	-
		120 FLEX	10,000 – 16,000	100	42777412	CDR 38 A 120 FLEX	-
75	A-FLEX	60 FLEX	5,000 – 9,000	50	42777706	CDR 75 A 60 FLEX	-
		80 FLEX	5,000 – 9,000	50	42777708	CDR 75 A 80 FLEX	-
		120 FLEX	5,000 – 9,000	50	42777712	CDR 75 A 120 FLEX	-



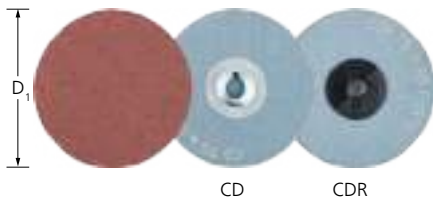



Aluminium oxide A-FORTE version

For general applications from coarse to fine grinding, with a high stock removal rate and long tool life.



Special features:

- High economic efficiency as tool can be changed quickly. Very comfortable due to ease of use and low-vibration working.
- No disruptions in use due to adhesion, slipping or coming loose.
- Please order necessary backing pad separately.

D ₁ [mm]	Abrasive	Grit size	Opt. RPM		Item no.	Designation	Price/unit EUR
CD system							
25	A-FORTE	60 FORTE	15,000 – 26,000	100	42751306	CD 25 A 60 FORTE	-
		80 FORTE	15,000 – 26,000	100	42751308	CD 25 A 80 FORTE	-
		120 FORTE	15,000 – 26,000	100	42751312	CD 25 A 120 FORTE	-
38	A-FORTE	36 FORTE	10,000 – 16,000	100	42751403	CD 38 A 36 FORTE	-
		60 FORTE	10,000 – 16,000	100	42751406	CD 38 A 60 FORTE	-
		80 FORTE	10,000 – 16,000	100	42751408	CD 38 A 80 FORTE	-
		120 FORTE	10,000 – 16,000	100	42751412	CD 38 A 120 FORTE	-
50	A-FORTE	36 FORTE	8,000 – 13,000	100	42751503	CD 50 A 36 FORTE	-
		60 FORTE	8,000 – 13,000	100	42751506	CD 50 A 60 FORTE	-
		80 FORTE	8,000 – 13,000	100	42751508	CD 50 A 80 FORTE	-
		120 FORTE	8,000 – 13,000	100	42751512	CD 50 A 120 FORTE	-
75	A-FORTE	36 FORTE	5,000 – 9,000	50	42751703	CD 75 A 36 FORTE	-
		60 FORTE	5,000 – 9,000	50	42751706	CD 75 A 60 FORTE	-
		80 FORTE	5,000 – 9,000	50	42751708	CD 75 A 80 FORTE	-
		120 FORTE	5,000 – 9,000	50	42751712	CD 75 A 120 FORTE	-
CDR system							
25	A-FORTE	60 FORTE	15,000 – 26,000	100	42771306	CDR 25 A 60 FORTE	-
		80 FORTE	15,000 – 26,000	100	42771308	CDR 25 A 80 FORTE	-
		120 FORTE	15,000 – 26,000	100	42771312	CDR 25 A 120 FORTE	-
38	A-FORTE	36 FORTE	10,000 – 16,000	100	42771403	CDR 38 A 36 FORTE	-
		60 FORTE	10,000 – 16,000	100	42771406	CDR 38 A 60 FORTE	-
		80 FORTE	10,000 – 16,000	100	42771408	CDR 38 A 80 FORTE	-
		120 FORTE	10,000 – 16,000	100	42771412	CDR 38 A 120 FORTE	-
50	A-FORTE	36 FORTE	8,000 – 13,000	100	42771503	CDR 50 A 36 FORTE	-
		60 FORTE	8,000 – 13,000	100	42771506	CDR 50 A 60 FORTE	-
		80 FORTE	8,000 – 13,000	100	42771508	CDR 50 A 80 FORTE	-
		120 FORTE	8,000 – 13,000	100	42771512	CDR 50 A 120 FORTE	-
75	A-FORTE	36 FORTE	5,000 – 9,000	50	42771703	CDR 75 A 36 FORTE	-
		60 FORTE	5,000 – 9,000	50	42771706	CDR 75 A 60 FORTE	-
		80 FORTE	5,000 – 9,000	50	42771708	CDR 75 A 80 FORTE	-
		120 FORTE	5,000 – 9,000	50	42771712	CDR 75 A 120 FORTE	-

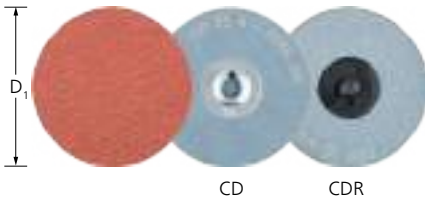



Aluminium oxide A-COOL version

For general applications from coarse to fine grinding on materials with challenging stock removal properties, e.g. stainless steel (INOX). Active grinding additives substantially improve the stock removal rate, prevent clogging and result in cooler grinding.



Special features:

- High economic efficiency as tool can be changed quickly. Very comfortable due to ease of use and low-vibration working.
- No disruptions in use due to adhesion, slipping or coming loose.
- Please order necessary backing pad separately.

D ₁ [mm]	Abrasive	Grit size	Opt. RPM		Item no.	Designation	Price/unit EUR
CD system 							
50	A-COOL	36	8,000 – 13,000	100	42752503	CD 50 A-COOL 36	-
		60	8,000 – 13,000	100	42752506	CD 50 A-COOL 60	-
		80	8,000 – 13,000	100	42752508	CD 50 A-COOL 80	-
75	A-COOL	36	5,000 – 9,000	50	42752703	CD 75 A-COOL 36	-
		60	5,000 – 9,000	50	42752706	CD 75 A-COOL 60	-
		80	5,000 – 9,000	50	42752708	CD 75 A-COOL 80	-
CDR system 							
50	A-COOL	36	8,000 – 13,000	100	42772503	CDR 50 A-COOL 36	-
		60	8,000 – 13,000	100	42772506	CDR 50 A-COOL 60	-
		80	8,000 – 13,000	100	42772508	CDR 50 A-COOL 80	-
75	A-COOL	36	5,000 – 9,000	50	42772703	CDR 75 A-COOL 36	-
		60	5,000 – 9,000	50	42772706	CDR 75 A-COOL 60	-
		80	5,000 – 9,000	50	42772708	CDR 75 A-COOL 80	-

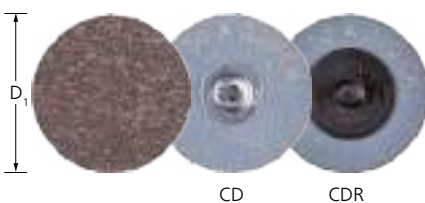



Aluminium oxide A compact grain version

Outstandingly suited to fine and very fine grinding, and for step-by-step preparations for polishing. The self-sharpening compact grain facilitates a very long tool life and achieves consistent surface quality levels throughout the entire tool life.



Special features:

- High economic efficiency as tool can be changed quickly. Very comfortable due to ease of use and low-vibration working.
- No disruptions in use due to adhesion, slipping or coming loose.
- Please order necessary backing pad separately. Only use backing pad with dia. 20–50 mm.

D ₁ [mm]	Abrasive	Grit size	Opt. RPM		Item no.	Designation	Price/unit EUR
CD system 							
50	A-CK	120	3,800 – 13,000	100	42755012	CD 50 A 120 CK	-
		180	3,800 – 13,000	100	42755018	CD 50 A 180 CK	-
		240	3,800 – 13,000	100	42755024	CD 50 A 240 CK	-
		320	3,800 – 13,000	100	42755032	CD 50 A 320 CK	-
		400	3,800 – 13,000	100	42755040	CD 50 A 400 CK	-
		600	3,800 – 13,000	100	42755060	CD 50 A 600 CK	-
		800	3,800 – 13,000	100	42755080	CD 50 A 800 CK	-
		1000	3,800 – 13,000	100	42755100	CD 50 A 1000 CK	-
75	A-CK	1200	3,800 – 13,000	100	42755120	CD 50 A 1200 CK	-
		120	2,500 – 9,000	50	42757012	CD 75 A 120 CK	-
		180	2,500 – 9,000	50	42757018	CD 75 A 180 CK	-
		400	2,500 – 9,000	50	42757040	CD 75 A 400 CK	-

Continued on next page



D ₁ [mm]	Abrasive	Grit size	Opt. RPM		Item no.	Designation	Price/unit EUR
75	A-CK	600	2,500 – 9,000	50	42757060	CD 75 A 600 CK	-
		800	2,500 – 9,000	50	42757080	CD 75 A 800 CK	-
		1000	2,500 – 9,000	50	42757100	CD 75 A 1000 CK	-
		1200	2,500 – 9,000	50	42757120	CD 75 A 1200 CK	-
CDR system							
50	A-CK	120	3,800 – 13,000	100	42795012	CDR 50 A 120 CK	-
		180	3,800 – 13,000	100	42795018	CDR 50 A 180 CK	-
		240	3,800 – 13,000	100	42795024	CDR 50 A 240 CK	-
		320	3,800 – 13,000	100	42795032	CDR 50 A 320 CK	-
		400	3,800 – 13,000	100	42795040	CDR 50 A 400 CK	-
		600	3,800 – 13,000	100	42795060	CDR 50 A 600 CK	-
		800	3,800 – 13,000	100	42795080	CDR 50 A 800 CK	-
		1000	3,800 – 13,000	100	42795100	CDR 50 A 1000 CK	-
		1200	3,800 – 13,000	100	42795120	CDR 50 A 1200 CK	-
75	A-CK	120	2,500 – 9,000	50	42797012	CDR 75 A 120 CK	-
		180	2,500 – 9,000	50	42797018	CDR 75 A 180 CK	-
		240	2,500 – 9,000	50	42797024	CDR 75 A 240 CK	-
		320	2,500 – 9,000	50	42797032	CDR 75 A 320 CK	-
		400	2,500 – 9,000	50	42797040	CDR 75 A 400 CK	-
		600	2,500 – 9,000	50	42797060	CDR 75 A 600 CK	-
		800	2,500 – 9,000	50	42797080	CDR 75 A 800 CK	-
		1000	2,500 – 9,000	50	42797100	CDR 75 A 1000 CK	-
		1200	2,500 – 9,000	50	42797120	CDR 75 A 1200 CK	-

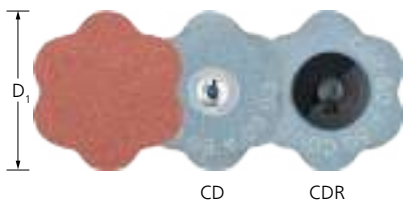



Aluminium oxide A-CONTOUR version

Very flexible and adaptable on account of the outer contour. Cutting into the workpiece is avoided.



Special features:

- High economic efficiency as tool can be changed quickly. Very comfortable due to ease of use and low-vibration working.
- No disruptions in use due to adhesion, slipping or coming loose.
- Please order necessary backing pad separately.

D ₁ [mm]	Abrasive	Grit size	Opt. RPM		Item no.	Designation	Price/unit EUR
CD system							
60	A	60 CONTOUR	7,500 – 11,000	50	42759001	CD 60 A 60 CONTOUR	-
		80 CONTOUR	7,500 – 11,000	50	42759002	CD 60 A 80 CONTOUR	-
		120 CONTOUR	7,500 – 11,000	50	42759003	CD 60 A 120 CONTOUR	-
		180 CONTOUR	7,500 – 11,000	50	42759004	CD 60 A 180 CONTOUR	-
CDR system							
60	A	60 CONTOUR	7,500 – 11,000	50	42759005	CDR 60 A 60 CONTOUR	-
		80 CONTOUR	7,500 – 11,000	50	42759006	CDR 60 A 80 CONTOUR	-
		120 CONTOUR	7,500 – 11,000	50	42759007	CDR 60 A 120 CONTOUR	-
		180 CONTOUR	7,500 – 11,000	50	42759008	CDR 60 A 180 CONTOUR	-

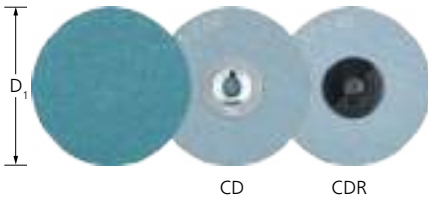

Zirconia alumina Z version

For coarse grinding work with a high stock removal rate and a long tool life. Particularly high stock removal rate in coarse grinding applications using grit sizes 36 and 60.



Special features:

- High economic efficiency as tool can be changed quickly. Very comfortable due to ease of use and low-vibration working.
- No disruptions in use due to adhesion, slipping or coming loose.
- Please order necessary backing pad separately.

D ₁ [mm]	Abrasive	Grit size	Opt. RPM		Item no.	Designation	Price/unit EUR
CD system							
38	Z	36	5,000 – 16,000	100	42753403	CD 38 Z 36	-
		60	5,000 – 16,000	100	42753406	CD 38 Z 60	-
		80	5,000 – 16,000	100	42753408	CD 38 Z 80	-
50	Z	36	3,800 – 13,000	100	42753503	CD 50 Z 36	-
		60	3,800 – 13,000	100	42753506	CD 50 Z 60	-
		80	3,800 – 13,000	100	42753508	CD 50 Z 80	-
75	Z	36	2,500 – 9,000	50	42753703	CD 75 Z 36	-
		60	2,500 – 9,000	50	42753706	CD 75 Z 60	-
		80	2,500 – 9,000	50	42753708	CD 75 Z 80	-
CDR system							
38	Z	36	5,000 – 16,000	100	42773403	CDR 38 Z 36	-
		60	5,000 – 16,000	100	42773406	CDR 38 Z 60	-
		80	5,000 – 16,000	100	42773408	CDR 38 Z 80	-
50	Z	36	3,800 – 13,000	100	42773503	CDR 50 Z 36	-
		60	3,800 – 13,000	100	42773506	CDR 50 Z 60	-
		80	3,800 – 13,000	100	42773508	CDR 50 Z 80	-
75	Z	36	2,500 – 9,000	50	42773703	CDR 75 Z 36	-
		60	2,500 – 9,000	50	42773706	CDR 75 Z 60	-
		80	2,500 – 9,000	50	42773708	CDR 75 Z 80	-

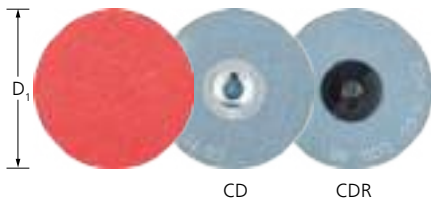



Ceramic oxide grain CO-COOL version

Consistently high performance and aggressive grinding due to self-sharpening ceramic oxide grain. Active grinding additives improve the stock removal rate, prevent clogging and result in cooler grinding on hard materials which do not conduct heat well.



Special features:

- High economic efficiency as tool can be changed quickly. Very comfortable due to ease of use and low-vibration working.
- No disruptions in use due to adhesion, slipping or coming loose.
- Please order necessary backing pad separately.

D ₁ [mm]	Abrasive	Grit size	Opt. RPM		Item no.	Designation	Price/unit EUR
CD system							
38	CO-COOL	24	5,000 – 16,000	100	42756402	CD 38 CO-COOL 24	-
		36	5,000 – 16,000	100	42756403	CD 38 CO-COOL 36	-
		60	5,000 – 16,000	100	42756406	CD 38 CO-COOL 60	-
		80	5,000 – 16,000	100	42756408	CD 38 CO-COOL 80	-
		120	5,000 – 16,000	100	42756412	CD 38 CO-COOL 120	-
50	CO-COOL	24	3,800 – 13,000	100	42756502	CD 50 CO-COOL 24	-
		36	3,800 – 13,000	100	42756503	CD 50 CO-COOL 36	-
		60	3,800 – 13,000	100	42756506	CD 50 CO-COOL 60	-
		80	3,800 – 13,000	100	42756508	CD 50 CO-COOL 80	-
		120	3,800 – 13,000	100	42756512	CD 50 CO-COOL 120	-
75	CO-COOL	24	2,500 – 9,000	50	42756702	CD 75 CO-COOL 24	-
		36	2,500 – 9,000	50	42756703	CD 75 CO-COOL 36	-
		60	2,500 – 9,000	50	42756706	CD 75 CO-COOL 60	-
		80	2,500 – 9,000	50	42756708	CD 75 CO-COOL 80	-
		120	2,500 – 9,000	50	42756712	CD 75 CO-COOL 120	-
CDR system							
38	CO-COOL	36	5,000 – 16,000	100	42776403	CDR 38 CO-COOL 36	-
		60	5,000 – 16,000	100	42776406	CDR 38 CO-COOL 60	-
		80	5,000 – 16,000	100	42776408	CDR 38 CO-COOL 80	-
		120	5,000 – 16,000	100	42776412	CDR 38 CO-COOL 120	-
50	CO-COOL	24	3,800 – 13,000	100	42776502	CDR 50 CO-COOL 24	-
		36	3,800 – 13,000	100	42776503	CDR 50 CO-COOL 36	-
		60	3,800 – 13,000	100	42776506	CDR 50 CO-COOL 60	-
		80	3,800 – 13,000	100	42776508	CDR 50 CO-COOL 80	-
		120	3,800 – 13,000	100	42776512	CDR 50 CO-COOL 120	-
75	CO-COOL	24	2,500 – 9,000	50	42776702	CDR 75 CO-COOL 24	-
		36	2,500 – 9,000	50	42776703	CDR 75 CO-COOL 36	-
		60	2,500 – 9,000	50	42776706	CDR 75 CO-COOL 60	-
		80	2,500 – 9,000	50	42776708	CDR 75 CO-COOL 80	-
		120	2,500 – 9,000	50	42776712	CDR 75 CO-COOL 120	-

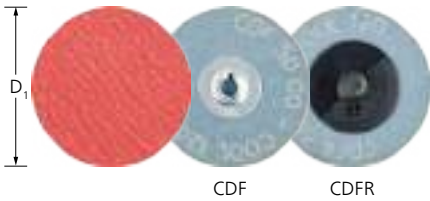



Ceramic oxide grain CO-COOL midget fibre discs type

Consistently high performance and aggressive grinding due to self-sharpening ceramic oxide grain. Active grinding additives improve the stock removal rate, prevent clogging and result in cooler grinding on hard materials which do not conduct heat well.

Special features:

- Excellent for surface and edge grinding. The fibre backing strengthens the abrasive disc and improves stock removal.
- High economic efficiency as tool can be changed quickly. Very comfortable due to ease of use and low-vibration working.
- Please order necessary backing pad separately. No disruptions in use due to adhesion, slipping or coming loose.

D ₁ [mm]	Abrasive	Grit size	Opt. RPM		Item no.	Designation	Price/unit EUR
CD system 							
50	CO-COOL	36	3,800 – 13,000	100	42749503	CDF 50 CO-COOL 36	-
		50	3,800 – 13,000	100	42749505	CDF 50 CO-COOL 50	-
		80	3,800 – 13,000	100	42749508	CDF 50 CO-COOL 80	-
		120	3,800 – 13,000	100	42749512	CDF 50 CO-COOL 120	-
75	CO-COOL	36	2,500 – 9,000	50	42749703	CDF 75 CO-COOL 36	-
		50	2,500 – 9,000	50	42749705	CDF 75 CO-COOL 50	-
		80	2,500 – 9,000	50	42749708	CDF 75 CO-COOL 80	-
		120	2,500 – 9,000	50	42749712	CDF 75 CO-COOL 120	-
CDR system 							
50	CO-COOL	36	3,800 – 13,000	100	42778503	CDFR 50 CO-COOL 36	-
		50	3,800 – 13,000	100	42778505	CDFR 50 CO-COOL 50	-
		80	3,800 – 13,000	100	42778508	CDFR 50 CO-COOL 80	-
		120	3,800 – 13,000	100	42778512	CDFR 50 CO-COOL 120	-
75	CO-COOL	36	2,500 – 9,000	50	42778703	CDFR 75 CO-COOL 36	-
		50	2,500 – 9,000	50	42778705	CDFR 75 CO-COOL 50	-
		80	2,500 – 9,000	50	42778708	CDFR 75 CO-COOL 80	-
		120	2,500 – 9,000	50	42778712	CDFR 75 CO-COOL 120	-

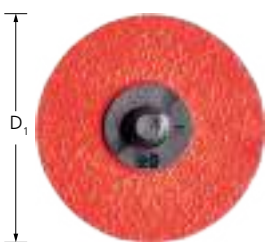



RS ceramic oxide grain CO-COOL midget fibre disc version

Consistently high performance and aggressive grinding due to self-sharpening ceramic oxide grain. Active grinding additives improve the stock removal rate, prevent clogging and result in cooler grinding on hard materials which do not conduct heat well.



Special features:

- Excellent for weld dressing of backwards repair welds, e.g. in cases, slots and grooves on engines.
- The abrasive coating is located on the underside of the tool. This enables convenient and safe backwards working in hard-to-reach areas.
- Ideal for work on welded-on combustor plates. Order necessary backing pad separately.

D ₁ [mm]	Abrasive	Grit size	Opt. RPM		Item no.	Designation	Price/unit EUR
CDR system 							
38	CO-COOL	50	10,000 – 16,000	100	42799010	CDFR 38 CO-COOL 50 RS	-
		80	10,000 – 16,000	100	47201013	CDFR 38 CO-COOL 80 RS	-
		120	10,000 – 16,000	100	42799011	CDFR 38 CO-COOL 120 RS	-
50	CO-COOL	50	3,800 – 13,000	100	42799012	CDFR 50 CO-COOL 50 RS	-
		80	3,800 – 13,000	100	47201007	CDFR 50 CO-COOL 80 RS	-
		120	3,800 – 13,000	100	42799013	CDFR 50 CO-COOL 120 RS	-
75	CO-COOL	50	2,500 – 9,000	50	42799014	CDFR 75 CO-COOL 50 RS	-

Continued on next page

D ₁ [mm]	Abrasive	Grit size	Opt. RPM		Item no.	Designation	Price/unit EUR
75	CO-COOL	80	2,500 – 9,000	50	47201014	CDFR 75 CO-COOL 80 RS	-
		120	2,500 – 9,000	50	42799015	CDFR 75 CO-COOL 120 RS	-





VICTOGRAIN-COOL version

For maximum aggressive grinding with an extremely long tool life, the ultimate stock removal rate and consistently high performance on steel and hard materials which do not conduct heat well. Active grinding additives in the coating prevent clogging and result in cooler grinding.

Special features:

- High economic efficiency as tool can be changed quickly. Very comfortable due to ease of use and low-vibration working.
- No disruptions in use due to adhesion, slipping or coming loose.
- Please order necessary backing pad separately.

D ₁ [mm]	Abrasive	Grit size	Opt. RPM		Item no.	Designation	Price/unit EUR
CD system							
38	VICTOGRAIN-COOL	36	5,000 – 16,000	100	42798001	CD 38 VICTOGRAIN-COOL 36	-
50	VICTOGRAIN-COOL	36	3,800 – 13,000	100	42798002	CD 50 VICTOGRAIN-COOL 36	-
75	VICTOGRAIN-COOL	36	2,500 – 9,000	50	42798003	CD 75 VICTOGRAIN-COOL 36	-
CDR system							
38	VICTOGRAIN-COOL	36	5,000 – 16,000	100	42799001	CDR 38 VICTOGRAIN-COOL 36	-
50	VICTOGRAIN-COOL	36	3,800 – 13,000	100	42799002	CDR 50 VICTOGRAIN-COOL 36	-
75	VICTOGRAIN-COOL	36	2,500 – 9,000	50	42799003	CDR 75 VICTOGRAIN-COOL 36	-

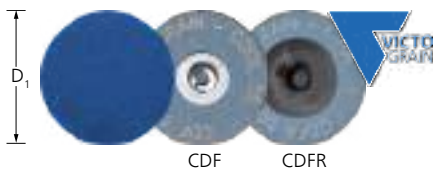



VICTOGRAIN-COOL midget fibre discs type

For maximum aggressive grinding with an extremely long tool life, the ultimate stock removal rate and consistently high performance on steel and hard materials which do not conduct heat well. Active grinding additives in the coating prevent clogging and result in cooler grinding.

Special features:

- Excellent for surface and edge grinding. The fibre backing strengthens the abrasive disc and improves stock removal.
- High economic efficiency as tool can be changed quickly. Very comfortable due to ease of use and low-vibration working.
- Please order necessary backing pad separately. No disruptions in use due to adhesion, slipping or coming loose.

D ₁ [mm]	Abrasive	Grit size	Opt. RPM		Item no.	Designation	Price/unit EUR
CD system							
38	VICTOGRAIN-COOL	36	5,000 – 16,000	100	42703836	CDF 38 VICTOGRAIN-COOL 36	-
50	VICTOGRAIN-COOL	36	3,800 – 13,000	100	42705036	CDF 50 VICTOGRAIN-COOL 36	-
75	VICTOGRAIN-COOL	36	2,500 – 9,000	50	42707536	CDF 75 VICTOGRAIN-COOL 36	-
CDR system							
38	VICTOGRAIN-COOL	36	5,000 – 16,000	100	42713836	CDFR 38 VICTOGRAIN-COOL 36	-
50	VICTOGRAIN-COOL	36	3,800 – 13,000	100	42715036	CDFR 50 VICTOGRAIN-COOL 36	-
75	VICTOGRAIN-COOL	36	2,500 – 9,000	50	42717536	CDFR 75 VICTOGRAIN-COOL 36	-

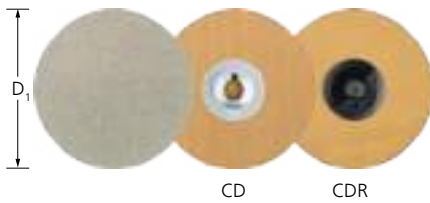

Diamond version

Excellent for work on extremely hard materials, wear-resistant coatings and for hard facings. Particularly recommended for work on materials used for aircraft engine construction.



Special features:

- High economic efficiency as tool can be changed quickly. Very comfortable due to ease of use and low-vibration working.
- Please order necessary backing pad separately. No disruptions in use due to adhesion, slipping or coming loose.
- The diamond grit sizes correspond to the following grit sizes according to ISO 6344: D 251 = P 60; D 126 = P 120; D 76 = P 220.

D ₁ [mm]	Abrasive	Grit size [µm]	Opt. RPM		Item no.	Designation	Price/unit EUR
CD system							
25	DIA	251	7,500 – 15,000	10	42740001	CD DIA 25 D 251 - P 60	-
		126	7,500 – 15,000	10	42740002	CD DIA 25 D 126 - P 120	-
		76	7,500 – 15,000	10	42740003	CD DIA 25 D 76 - P 220	-
38	DIA	251	5,000 – 10,000	10	42740004	CD DIA 38 D 251 - P 60	-
		126	5,000 – 10,000	10	42740005	CD DIA 38 D 126 - P 120	-
		76	5,000 – 10,000	10	42740006	CD DIA 38 D 76 - P 220	-
50	DIA	251	3,800 – 7,500	10	42740007	CD DIA 50 D 251 - P 60	-
		126	3,800 – 7,500	10	42740008	CD DIA 50 D 126 - P 120	-
		76	3,800 – 7,500	10	42740009	CD DIA 50 D 76 - P 220	-
75	DIA	251	2,500 – 5,000	10	42740010	CD DIA 75 D 251 - P 60	-
		126	2,500 – 5,000	10	42740011	CD DIA 75 D 126 - P 120	-
		76	2,500 – 5,000	10	42740012	CD DIA 75 D 76 - P 220	-
CDR system							
25	DIA	251	7,500 – 15,000	10	42758001	CDR DIA 25 D 251 - P 60	-
		126	7,500 – 15,000	10	42758002	CDR DIA 25 D 126 - P 120	-
38	DIA	251	5,000 – 10,000	10	42758004	CDR DIA 38 D 251 - P 60	-
		126	5,000 – 10,000	10	42758005	CDR DIA 38 D 126 - P 120	-
50	DIA	251	3,800 – 7,500	10	42758007	CDR DIA 50 D 251 - P 60	-
		126	3,800 – 7,500	10	42758008	CDR DIA 50 D 126 - P 120	-
		76	3,800 – 7,500	10	42758009	CDR DIA 50 D 76 - P 220	-







Silicon carbide SiC version

For general grinding work on components made of aluminium, copper, bronze, titanium and fibre-reinforced plastics. Particularly recommended for use on titanium alloys. Ideally suited for use in the aircraft industry, particularly when SiC is the only abrasive approved for use.



Special features:

- High economic efficiency as tool can be changed quickly. Very comfortable due to ease of use and low-vibration working.
- No disruptions in use due to adhesion, slipping or coming loose.
- Please order necessary backing pad separately.

D ₁ [mm]	Abrasive	Grit size	Opt. RPM		Item no.	Designation	Price/unit EUR
CD system 							
50	SiC	36	3,800 – 13,000	100	42754503	CD 50 SiC 36	-
		60	3,800 – 13,000	100	42754506	CD 50 SiC 60	-
		80	3,800 – 13,000	100	42754508	CD 50 SiC 80	-
		120	3,800 – 13,000	100	42754512	CD 50 SiC 120	-
		240	3,800 – 13,000	100	42754524	CD 50 SiC 240	-
75	SiC	36	2,500 – 9,000	50	42754703	CD 75 SiC 36	-
		60	2,500 – 9,000	50	42754706	CD 75 SiC 60	-
		80	2,500 – 9,000	50	42754708	CD 75 SiC 80	-
		120	2,500 – 9,000	50	42754712	CD 75 SiC 120	-
		240	2,500 – 9,000	50	42754724	CD 75 SiC 240	-
CDR system 							
50	SiC	36	3,800 – 13,000	100	42774503	CDR 50 SiC 36	-
		60	3,800 – 13,000	100	42774506	CDR 50 SiC 60	-
		80	3,800 – 13,000	100	42774508	CDR 50 SiC 80	-
		120	3,800 – 13,000	100	42774512	CDR 50 SiC 120	-
		240	3,800 – 13,000	100	42774524	CDR 50 SiC 240	-
75	SiC	36	2,500 – 9,000	50	42774703	CDR 75 SiC 36	-
		60	2,500 – 9,000	50	42774706	CDR 75 SiC 60	-
		80	2,500 – 9,000	50	42774708	CDR 75 SiC 80	-
		120	2,500 – 9,000	50	42774712	CDR 75 SiC 120	-
		240	2,500 – 9,000	50	42774724	CDR 75 SiC 240	-





RS silicon carbide SiC version

For general grinding work on components made of aluminium, copper, bronze, titanium and fibre-reinforced plastics. Particularly recommended for use on titanium alloys. Ideally suited for use in the aircraft industry, particularly when SiC is the only abrasive approved for use.



Special features:

- Excellent for weld dressing of backwards repair welds, e.g. in cases, slots and grooves on engines.
- The abrasive coating is located on the underside of the tool. This enables convenient and safe backwards working in hard-to-reach areas.
- Ideal for work on welded-on combustor plates. Order necessary backing pad separately.

D ₁ [mm]	Abrasive	Grit size	Opt. RPM		Item no.	Designation	Price/unit EUR
CDR system 							
38	SiC	60	10,000 – 16,000	100	42799016	CDR 38 SiC 60 RS	-
		80	10,000 – 16,000	100	42799017	CDR 38 SiC 80 RS	-
		120	10,000 – 16,000	100	42799018	CDR 38 SiC 120 RS	-
50	SiC	60	3,800 – 13,000	100	42799019	CDR 50 SiC 60 RS	-
		80	3,800 – 13,000	100	42799020	CDR 50 SiC 80 RS	-
		120	3,800 – 13,000	100	42799021	CDR 50 SiC 120 RS	-
75	SiC	60	2,500 – 9,000	50	42799022	CDR 75 SiC 60 RS	-
		80	2,500 – 9,000	50	42799023	CDR 75 SiC 80 RS	-
		120	2,500 – 9,000	50	42799024	CDR 75 SiC 120 RS	-

POLICLEAN discs CD, CDR

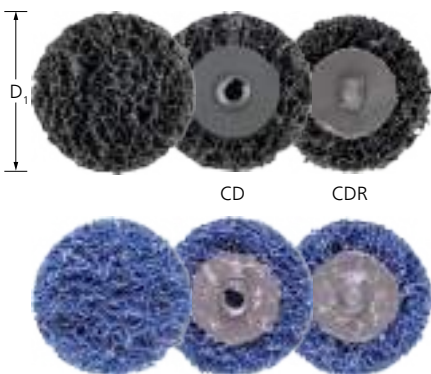



PCLR and PCLR PLUS types

For coarse cleaning work, such as removing paint, scale, heat discoloration, rust and adhesive residues in face-down grinding. POLICLEAN-PLUS discs (blue) exhibit a higher stock removal rate with a very long tool life. Available in the aluminium oxide A and silicon carbide SiC types.

Special features:

- High economic efficiency as tool can be changed quickly. Very comfortable due to ease of use and low-vibration working.
- No disruptions in use due to adhesion, slipping or coming loose.
- Please order necessary backing pad separately.

D ₁ [mm]	Version	Abrasive	Opt. RPM		Item no.	Designation	Price/unit EUR
CD system 							
50	PCLR	SiC	5,500 – 8,000	10	42780050	CD 50 PCLR	-
	PCLR PLUS	A	5,500 – 8,000	10	42780051	CD 50 PCLR PLUS	-
75	PCLR	SiC	3,800 – 5,000	10	42780075	CD 75 PCLR	-
	PCLR PLUS	A	3,800 – 5,000	10	42780076	CD 75 PCLR PLUS	-
CDR system 							
50	PCLR	SiC	5,500 – 8,000	10	47201632	CDR 50 PCLR	-
	PCLR PLUS	A	5,500 – 8,000	10	42780052	CDR 50 PCLR PLUS	-
75	PCLR	SiC	3,800 – 5,000	10	47201633	CDR 75 PCLR	-
	PCLR PLUS	A	3,800 – 5,000	10	42780077	CDR 75 PCLR PLUS	-



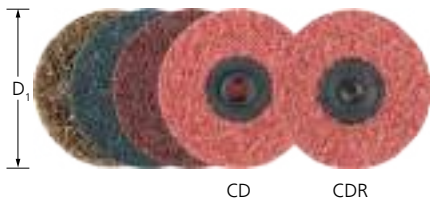

Hard type VRH

Suitable for general work on small and medium-sized metal surfaces, e.g. removing rough grinding traces, removing oxidation and light deburring work. Achieve matt and satin-finished surfaces.



Special features:

- High economic efficiency as tool can be changed quickly. Very comfortable due to ease of use and low-vibration working.
- No disruptions in use due to adhesion, slipping or coming loose.
- Please order necessary backing pad separately.

D ₁ [mm]	Abrasive	Grit size	Version	Opt. RPM		Item no.	Designation	Price/unit EUR
CD system 								
20	A	100 G	coarse, yellow-brown	14,000 – 19,000	50	47201114	CD VRH 20 A 100 G	-
		180 M	medium, red-brown	14,000 – 19,000	50	47201102	CD VRH 20 A 180 M	-
		240 F	fine, blue	14,000 – 19,000	50	42761204	CD VRH 20 A 240 F	-
25	A	100 G	coarse, yellow-brown	11,000 – 15,000	50	42761251	CD VRH 25 A 100 G	-
		180 M	medium, red-brown	11,000 – 15,000	50	42761252	CD VRH 25 A 180 M	-
		240 F	fine, blue	11,000 – 15,000	50	42761254	CD VRH 25 A 240 F	-
38	A	100 G	coarse, yellow-brown	7,000 – 10,000	50	42761381	CD VRH 38 A 100 G	-
		180 M	medium, red-brown	7,000 – 10,000	50	42761382	CD VRH 38 A 180 M	-
		240 F	fine, blue	7,000 – 10,000	50	42761384	CD VRH 38 A 240 F	-
50	A	100 G	coarse, yellow-brown	5,500 – 7,500	50	42761501	CD VRH 50 A 100 G	-
		180 M	medium, red-brown	5,500 – 7,500	50	42761502	CD VRH 50 A 180 M	-
		240 F	fine, blue	5,500 – 7,500	50	42761504	CD VRH 50 A 240 F	-
75	A	100 G	coarse, yellow-brown	3,800 – 5,000	25	42761751	CD VRH 75 A 100 G	-
		180 M	medium, red-brown	3,800 – 5,000	25	42761752	CD VRH 75 A 180 M	-
		240 F	fine, blue	3,800 – 5,000	25	42761754	CD VRH 75 A 240 F	-
CDR system 								
38	A	100 G	coarse, yellow-brown	7,000 – 10,000	50	42781381	CDR VRH 38 A 100 G	-
		180 M	medium, red-brown	7,000 – 10,000	50	42781382	CDR VRH 38 A 180 M	-
		240 F	fine, blue	7,000 – 10,000	50	42781384	CDR VRH 38 A 240 F	-
50	A	100 G	coarse, yellow-brown	5,500 – 7,500	50	42781501	CDR VRH 50 A 100 G	-
		180 M	medium, red-brown	5,500 – 7,500	50	42781502	CDR VRH 50 A 180 M	-
		240 F	fine, blue	5,500 – 7,500	50	42781504	CDR VRH 50 A 240 F	-
75	A	100 G	coarse, yellow-brown	3,800 – 5,000	25	42781751	CDR VRH 75 A 100 G	-
		180 M	medium, red-brown	3,800 – 5,000	25	42781752	CDR VRH 75 A 180 M	-
		240 F	fine, blue	3,800 – 5,000	25	42781754	CDR VRH 75 A 240 F	-

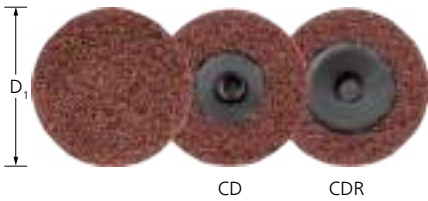



Soft type VRW

Suitable for very fine grinding on small and medium-sized surfaces and contours, and for cleaning metal and painted surfaces. Achieve matt and satin-finished surfaces. Highly open structure.



Special features:

- High economic efficiency as tool can be changed quickly. Very comfortable due to ease of use and low-vibration working.
- No disruptions in use due to adhesion, slipping or coming loose.
- Please order necessary backing pad separately.

D ₁ [mm]	Abrasive	Grit size	Version	Opt. RPM		Item no.	Designation	Price/unit EUR
CD system 								
38	A	100	medium	7,000 – 10,000	50	47201079	CD VRW 38 A 100	-
		180	fine	7,000 – 10,000	50	47201070	CD VRW 38 A 180	-
		280	very fine	7,000 – 10,000	50	47201071	CD VRW 38 A 280	-
50	A	100	medium	5,500 – 7,500	50	42760502	CD VRW 50 A 100	-
		180	fine	5,500 – 7,500	50	42760503	CD VRW 50 A 180	-
		280	very fine	5,500 – 7,500	50	42760504	CD VRW 50 A 280	-
75	A	100	medium	3,800 – 5,000	25	42760752	CD VRW 75 A 100	-
		180	fine	3,800 – 5,000	25	42760753	CD VRW 75 A 180	-
		280	very fine	3,800 – 5,000	25	42760754	CD VRW 75 A 280	-
CDR system 								
50	A	100	medium	5,500 – 7,500	50	42780502	CDR VRW 50 A 100	-
		180	fine	5,500 – 7,500	50	42780503	CDR VRW 50 A 180	-
		280	very fine	5,500 – 7,500	50	42780504	CDR VRW 50 A 280	-
75	A	100	medium	3,800 – 5,000	25	42780752	CDR VRW 75 A 100	-
		180	fine	3,800 – 5,000	25	42780753	CDR VRW 75 A 180	-
		280	very fine	3,800 – 5,000	25	42780754	CDR VRW 75 A 280	-





PNER type

For achieving a very fine, uniform surface finish which, depending on requirements, is a sufficient preparation for high-gloss polishing. Particularly suitable for work on small and medium-sized surfaces on stainless steel (INOX) components.





Special features:

- High economic efficiency as tool can be changed quickly. Very comfortable due to ease of use and low-vibration working.
- No disruptions in use due to adhesion, slipping or coming loose.
- Please order necessary backing pad separately.

D ₁ [mm]	Version	Abrasive	Grit size	Opt. RPM	Max. RPM		Item no.	Designation	Price/unit EUR
CD system 									
50	W (soft)	A	G (coarse)	9,500	19,100	25	42759021	CD PNER-W 5006 A G	-
		SiC	F (fine)	9,500	19,100	25	42759024	CD PNER-W 5006 SiC F	-
	MH (medium-hard)	A	F (fine)	9,500	19,100	25	42759102	CD PNER-MH 5006 A F	-
		SiC	F (fine)	9,500	19,100	25	42759104	CD PNER-MH 5006 SiC F	-

Continued on next page



D ₁ [mm]	Version	Abrasive	Grit size	Opt. RPM	Max. RPM		Item no.	Designation	Price/unit EUR
50	H (hard)	A	G (coarse)	9,500	19,100	25	42759141	CD PNER-H 5006 A G	-
			F (fine)	9,500	19,100	25	42759142	CD PNER-H 5006 A F	-
75	W (soft)	A	G (coarse)	6,400	12,500	25	42759031	CD PNER-W 7506 A G	-
			SiC	F (fine)	6,400	12,500	25	42759034	CD PNER-W 7506 SiC F
	MH (medium-hard)	A	F (fine)	6,400	12,500	25	42759112	CD PNER-MH 7506 A F	-
			SiC	F (fine)	6,400	12,500	25	42759114	CD PNER-MH 7506 SiC F
	H (hard)	A	G (coarse)	6,400	12,500	25	42759151	CD PNER-H 7506 A G	-
			F (fine)	6,400	12,500	25	42759152	CD PNER-H 7506 A F	-
CDR system 									
50	W (soft)	A	G (coarse)	9,500	19,100	25	42779021	CDR PNER-W 5006 A G	-
			SiC	F (fine)	9,500	19,100	25	42779024	CDR PNER-W 5006 SiC F
	MH (medium-hard)	A	F (fine)	9,500	19,100	25	42779102	CDR PNER-MH 5006 A F	-
			SiC	F (fine)	9,500	19,100	25	42779104	CDR PNER-MH 5006 SiC F
	H (hard)	A	G (coarse)	9,500	19,100	25	42779141	CDR PNER-H 5006 A G	-
			F (fine)	9,500	19,100	25	42779142	CDR PNER-H 5006 A F	-
75	W (soft)	A	G (coarse)	6,400	12,500	25	42779031	CDR PNER-W 7506 A G	-
			SiC	F (fine)	6,400	12,500	25	42779034	CDR PNER-W 7506 SiC F
	MH (medium-hard)	A	F (fine)	6,400	12,500	25	42779112	CDR PNER-MH 7506 A F	-
			SiC	F (fine)	6,400	12,500	25	42779114	CDR PNER-MH 7506 SiC F
	H (hard)	A	G (coarse)	6,400	12,500	25	42779151	CDR PNER-H 7506 A G	-
			F (fine)	6,400	12,500	25	42779152	CDR PNER-H 7506 A F	-



TX discs CD





Aluminium oxide A version

For achieving fine, matt surface finishes in one process. The very sturdy granular bond facilitates very aggressive abrasive performance. Particularly suitable for work on stainless steel (INOX) and aluminium.



Special features:

- High economic efficiency as tool can be changed quickly. Very comfortable due to ease of use and low-vibration working.
- No disruptions in use due to adhesion, slipping or coming loose.
- Please order necessary backing pad separately.

D ₁ [mm]	Abrasive	Grit size	Opt. RPM		Item no.	Designation	Price/unit EUR
CD system 							
50	A	80 TX	7,500 – 9,500	25	42762508	CD 50 A 80 TX	-
75	A	320 TX	5,000 – 6,500	25	42762732	CD 75 A 320 TX	-





FR version

Suitable for polishing with polishing paste bars, grinding pastes or diamond polishing pastes in face-down grinding on small and medium-sized surfaces.



Special features:

- High economic efficiency as tool can be changed quickly. Very comfortable due to ease of use and low-vibration working.
- No disruptions in use due to adhesion, slipping or coming loose.
- Please order necessary backing pad separately.

D ₁ [mm]	Opt. RPM		Item no.	Designation	Price/unit EUR
CD system 					
50	2,000 – 4,000	10	42770050	CD FR 50	-
75	1,200 – 2,500	10	42770075	CD FR 75	-
CDR system 					
50	2,000 – 4,000	10	42003050	CDR FR 50	-
75	1,200 – 2,500	10	42003075	CDR FR 75	-



Abrasive disc holder

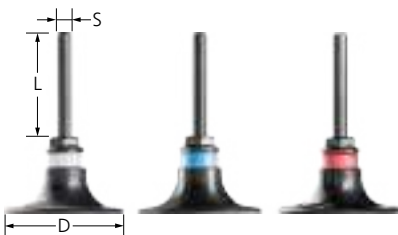



SBH, SBHR types

Matching arbors for COMBIDISC grinding tools. Available in three different hardness grades.

Special features:

- High economic efficiency as tool can be changed quickly. Very comfortable due to ease of use and low-vibration working.
- No disruptions in use due to adhesion, slipping or coming loose.
- The different hardness grades are colour-coded: W (soft) = grey; M (medium) = blue; H (hard) = red.

D [mm]	S [mm]	L [mm]	Hardness	Max. RPM		Item no.	Designation	Price/unit EUR
CD system 								
20	6	40	M (medium)	47,500	1	42721202	SBH 20 M	-
25	6	40	M (medium)	38,000	1	42721252	SBH 25 M	-
38	6	40	W (soft)	25,000	1	42721383	SBH 38 W	-
			M (medium)	25,000	1	42721382	SBH 38 M	-
			H (hard)	25,000	1	42721381	SBH 38 H	-
50	6	40	W (soft)	19,000	1	42721503	SBH 50 W	-
			M (medium)	19,000	1	42721502	SBH 50 M	-
			H (hard)	19,000	1	42721501	SBH 50 H	-
75	6	40	W (soft)	12,500	1	42721753	SBH 75 W	-
			M (medium)	12,500	1	42721752	SBH 75 M	-
			H (hard)	12,500	1	42721751	SBH 75 H	-
CDR system 								
20	6	40	M (medium)	47,500	1	42721212	SBHR 20 M	-
25	6	40	M (medium)	38,000	1	42721262	SBHR 25 M	-
38	6	40	W (soft)	25,000	1	42721393	SBHR 38 W	-
			M (medium)	25,000	1	42721392	SBHR 38 M	-
			H (hard)	25,000	1	42721391	SBHR 38 H	-
50	6	40	W (soft)	19,000	1	42721513	SBHR 50 W	-

Continued on next page

D [mm]	S [mm]	L [mm]	Hardness	Max. RPM		Item no.	Designation	Price/unit EUR
50	6	40	M (medium)	19,000	1	42721512	SBHR 50 M	-
			H (hard)	19,000	1	42721511	SBHR 50 H	-
75	6	40	W (soft)	12,500	1	42721763	SBHR 75 W	-
			M (medium)	12,500	1	42721762	SBHR 75 M	-
			H (hard)	12,500	1	42721761	SBHR 75 H	-



AF 14-1/4 CD



SPV-20 CD 1/4-20 UNC



AF M5 CD 1/4-20 UNC

Flexible shaft adapter

The shank of the abrasive disc holders can be replaced by suitable adapters. This enables the abrasive disc holder to be mounted directly to the drive spindle of the tool drive.

Special features:

- AF 14-1/4 CD, female thread M14, male thread 1/4-20 UNC. Suitable for drives with M14 spindle.
- SPV-20 CD 1/4-20 UNC, female thread 1/4-20 UNC, male thread 1/4-20 UNC. Suitable for drives with spindle 1/4-20 UNC, e.g. for PW 3/120 DH.
- AF M5 CD 1/4-20 UNC, male thread M5, male thread 1/4-20 UNC. Suitable for cordless angle grinder dia. 75 mm with M5 spindle (female thread).

	Item no.	Designation	Price/unit EUR
1	84205010	AF 14-1/4 CD	-
	87100727	SPV20 CD 1/4-20 UNC	-
	84205030	AF M5 CD 1/4-20 UNC	-

COMBIDISC set



COMBIDISC set

Set of various COMBIDISC tools.

Contents:

Three each of the following COMBIDISC abrasive discs: CD A 60 FORTE, CD A 120 FORTE, CD A-COOL 60, CD CO-COOL 36, CD Z 60, three each of the following COMBIDISC non-woven discs: CD VRH A 180 M, CD VRW A 100 and one abrasive disc holder SBH M.

Special features:

- Getting to know and testing the comprehensive system.
- Coordinated selection of the most common versions.

D [mm]		Item no.	Designation	Price/unit EUR
50	1	42790050	COMBIDISC SET 50	-
75	1	42790075	COMBIDISC SET 75	-

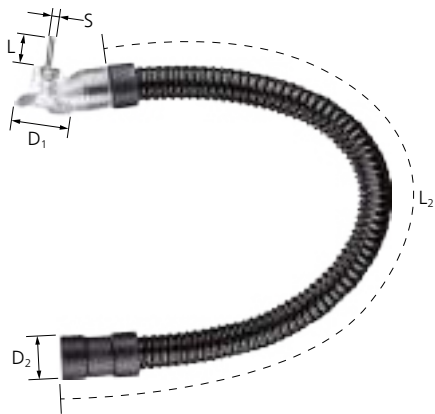

DUST REMOVER

The COMBIDISC DUST REMOVER removes grinding dust very effectively from the place that is being worked on. It can be used with all dust extraction systems (mobile or stationary). The DUST REMOVER is used with CD and CDR type backing pads.



Special features:

- Clean, low-dust working environment.
- Compatible with all drive systems.
- Flexible hose for good accessibility.

D ₁ [mm]	S [mm]	L [mm]	Thread	D ₂ [mm]	L ₂ [mm]	Suitable arbors		Item no.	Designation	Price/ unit EUR
50	6	27	1/4-20 UNC	37	600	CD/CDR 50	1	42791050	CD DUST REMOVER CD-DR 50	-
75	6	27	1/4-20 UNC	37	600	CD/CDR 75	1	42791075	CD DUST REMOVER CD-DR 75	-



The quick way to find the perfect tool

Material group ▾			Abrasive ▶									
			Rec. cutting speeds for short and long belts [m/s]	Aluminium oxide A	Aluminium oxide A compact grain	Zirconia alumina Z	Aluminium oxide A-COOL	Ceramic oxide grain CO	Ceramic oxide grain CO-COOL	VICTOGRAIN-COOL	Non-woven material	Felt
Steel, cast steel	Non-hardened, non-heat-treated steels	Construction steels, carbon steels, tool steels, non-alloyed steels, cast steel	25–35	●		○		●		●	●	●
	Hardened, heat-treated steels	Tool steels, tempering steels, alloyed steels, cast steel	20–30	○	●	●		●		●	○	●
Stainless steel (INOX)	Rust and acid-resistant steels	Austenitic and ferritic stainless steels	15–25		●	○	●		●	●	●	●
Non-ferrous metals	Soft non-ferrous metals, non-ferrous metals	Soft aluminium alloys	30–40	○			●		○		●	●
		Brass, copper, zinc		●		○		○			●	●
	Hard non-ferrous metals	Hard aluminium alloys	20–30	●		○		○			●	●
		Bronze, titanium				○		○	●	●	●	●
	High-temperature-resistant materials	Nickel-based and cobalt-based alloys	5–15			○		○	●	●	●	●
Cast iron	Grey cast iron, white cast iron	Cast iron with flake graphite EN-GJL (GG), with nodular graphite/nodular cast iron EN-GJS (GGG), white annealed cast iron EN-GJMW (GTW), black annealed cast iron EN-GJMB (GTS)	25–35	●		○		●			●	
Plastics, other materials		Fibre-reinforced plastics, thermoplastics, wood, chipboard, paint	10–25	●							●	●

● = highly suitable ○ = suitable

Safety notes

- Follow the safety notes from FEPA (Federation of European Producers of Abrasives) "Safety notes for correct use of abrasive belts". This information can be found in the download area on www.pferd.com.

 Wear eye protection!

 Wear hearing protection!

 Wear gloves!

 Wear a dust mask!

 Follow the safety instructions!

 Not permitted for wet grinding!



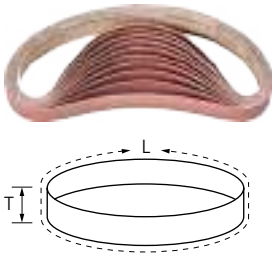

Aluminium oxide A version

For general applications from coarse to fine grinding.



Special features:

- High economic efficiency due to high abrasive performance and long tool life.
- High tear strength with optimum flexibility.
- Consistent results through very good grain adhesion.

L [mm]	T [mm]	Abrasive	Grit size	Acc. to ISO		Item no.	Designation	Price/ unit EUR	
305	3	A	60	-	100	45001953	BA 3/305 T A 60	-	
			120	-	100	45001955	BA 3/305 T A 120	-	
	6	A	60	-	100	45001983	BA 6/305 T A 60	-	
			80	-	100	45001984	BA 6/305 T A 80	-	
			180	-	100	45001987	BA 6/305 T A 180	-	
	9	A	60	-	100	45002223	BA 9/305 T A 60	-	
			80	-	100	45002224	BA 9/305 T A 80	-	
			120	-	100	45002225	BA 9/305 T A 120	-	
			180	-	100	45002227	BA 9/305 T A 180	-	
	12	A	40	-	100	45002331	BA 12/305 X A 40	-	
			60	-	100	45002333	BA 12/305 T A 60	-	
			80	-	100	45002334	BA 12/305 T A 80	-	
			120	-	100	45002335	BA 12/305 T A 120	-	
			180	-	100	45002337	BA 12/305 T A 180	-	
	330	10	A	60	ISO 2976	100	45002236	BA 10/330 T A 60	-
				80	ISO 2976	100	45002238	BA 10/330 T A 80	-
120				ISO 2976	100	45002242	BA 10/330 T A 120	-	
180				ISO 2976	100	45002248	BA 10/330 T A 180	-	
450	35	A	60	-	20	45005206	BA 35/450 X A 60	-	
			100	-	20	45005210	BA 35/450 X A 100	-	
			240	-	20	45005224	BA 35/450 X A 240	-	
	50	A	40	ISO 2976	20	45005404	BA 50/450 X A 40	-	
			60	ISO 2976	20	45005406	BA 50/450 X A 60	-	
			100	ISO 2976	20	45005410	BA 50/450 X A 100	-	
			240	ISO 2976	20	45005424	BA 50/450 X A 240	-	
	35	A	320	-	20	45005232	BA 35/450 X A 320	-	
	457	13	A	40	ISO 2976	100	45002624	BA 13/457 X A 40	-
				60	ISO 2976	100	45002626	BA 13/457 T A 60	-
80				ISO 2976	100	45002628	BA 13/457 T A 80	-	
120				ISO 2976	100	45002632	BA 13/457 T A 120	-	
480	16	A	60	-	50	45002706	BA 16/480 T A 60	-	
			120	-	50	45002712	BA 16/480 T A 120	-	
	20	A	40	ISO 2976	10	45004904	BA 20/480 X A 40	-	
			50	ISO 2976	10	45002905	BA 20/480 T A 50	-	
			60	ISO 2976	10	45002906	BA 20/480 T A 60	-	
			80	ISO 2976	10	45002908	BA 20/480 T A 80	-	
			120	ISO 2976	10	45002912	BA 20/480 T A 120	-	
			180	ISO 2976	10	45002918	BA 20/480 T A 180	-	
	25	A	240	ISO 2976	10	45002924	BA 20/480 T A 240	-	
			40	ISO 2976	20	45005104	BA 25/480 X A 40	-	
			120	ISO 2976	20	45005112	BA 25/480 T A 120	-	

Continued on next page

Flexible abrasives

Short belts BA



L [mm]	T [mm]	Abrasive	Grit size	Acc. to ISO		Item no.	Designation	Price/ unit EUR
520	3	A	40	-	100	45001971	BA 3/520 X A 40	-
			60	-	100	45001973	BA 3/520 T A 60	-
			80	-	100	45001974	BA 3/520 T A 80	-
			120	-	100	45001975	BA 3/520 T A 120	-
			180	-	100	45001977	BA 3/520 T A 180	-
			240	-	100	45001978	BA 3/520 T A 240	-
	6	A	40	ISO 2976	100	45004104	BA 6/520 X A 40	-
			60	ISO 2976	100	45002106	BA 6/520 J A 60	-
			80	ISO 2976	100	45002108	BA 6/520 J A 80	-
			120	ISO 2976	100	45002112	BA 6/520 J A 120	-
			180	ISO 2976	100	45002118	BA 6/520 T A 180	-
			240	ISO 2976	100	45002124	BA 6/520 T A 240	-
	12	A	40	-	100	45004504	BA 12/520 X A 40	-
			60	-	100	45002506	BA 12/520 J A 60	-
			80	-	100	45002508	BA 12/520 J A 80	-
			120	-	100	45002512	BA 12/520 J A 120	-
			180	-	100	45002518	BA 12/520 T A 180	-
			240	-	100	45002524	BA 12/520 T A 240	-
	16	A	40	-	50	45004804	BA 16/520 X A 40	-
			60	-	50	45002806	BA 16/520 T A 60	-
			80	-	50	45002808	BA 16/520 T A 80	-
			120	-	50	45002812	BA 16/520 T A 120	-
			180	-	50	45002818	BA 16/520 T A 180	-
			240	-	50	45002824	BA 16/520 T A 240	-
	20	A	40	ISO 2976	20	45005004	BA 20/520 X A 40	-
			60	ISO 2976	20	45003006	BA 20/520 T A 60	-
			80	ISO 2976	20	45003008	BA 20/520 T A 80	-
			120	ISO 2976	20	45003012	BA 20/520 T A 120	-
			180	ISO 2976	20	45003018	BA 20/520 T A 180	-
			240	ISO 2976	20	45003024	BA 20/520 T A 240	-
533	30	A	40	ISO 2976	20	45005142	BA 30/533 X A 40	-
			60	ISO 2976	20	45005146	BA 30/533 X A 60	-
			80	ISO 2976	20	45005148	BA 30/533 X A 80	-
			120	ISO 2976	20	45005152	BA 30/533 X A 120	-
			180	ISO 2976	20	45005118	BA 30/533 T A 180	-
			240	ISO 2976	20	45005124	BA 30/533 T A 240	-
			320	ISO 2976	20	45005132	BA 30/533 T A 320	-
	75	A	40	ISO 2976	10	45001104	BA 75/533 X A 40	-
			60	ISO 2976	10	45001106	BA 75/533 X A 60	-
			80	ISO 2976	10	45001108	BA 75/533 X A 80	-
			100	ISO 2976	10	45001110	BA 75/533 X A 100	-
			120	ISO 2976	10	45001112	BA 75/533 X A 120	-
			180	-	10	45002606	BA 12/610 J A 60	-
			240	-	10	45002608	BA 12/610 J A 80	-
610	12	A	40	-	100	45004604	BA 12/610 X A 40	-
			60	-	100	45002606	BA 12/610 J A 60	-
			80	-	100	45002608	BA 12/610 J A 80	-
			120	-	100	45002612	BA 12/610 J A 120	-
	30	A	40	-	10	45005153	BA 30/610 X A 40	-
			60	-	10	45005154	BA 30/610 X A 60	-
			80	-	10	45005155	BA 30/610 X A 80	-
			120	-	10	45005156	BA 30/610 X A 120	-
			180	-	10	45005157	BA 30/610 T A 180	-
			240	-	10	45005158	BA 30/610 T A 240	-

Continued on next page

L [mm]	T [mm]	Abrasive	Grit size	Acc. to ISO		Item no.	Designation	Price/unit EUR
610	100	A	40	ISO 2976	10	45001304	BA 100/610 X A 40	-
			60	ISO 2976	10	45001306	BA 100/610 X A 60	-
			80	ISO 2976	10	45001308	BA 100/610 X A 80	-
			100	ISO 2976	10	45001310	BA 100/610 X A 100	-
			120	ISO 2976	10	45001312	BA 100/610 X A 120	-
760	40	A	40	-	10	45000205	BA 40/760 A 40	-
			60	-	10	45000206	BA 40/760 A 60	-
			80	-	10	45000207	BA 40/760 A 80	-
			120	-	10	45000208	BA 40/760 A 120	-
820	40	A	40	-	10	45000220	BA 40/820 A 40	-
			60	-	10	45000221	BA 40/820 A 60	-
			80	-	10	45000222	BA 40/820 A 80	-
			120	-	10	45000223	BA 40/820 A 120	-
920	100	A	40	-	10	45005864	BA 100/920 X A 40	-
			60	-	10	45005866	BA 100/920 X A 60	-
			80	-	10	45005868	BA 100/920 X A 80	-
			120	-	10	45005872	BA 100/920 X A 120	-

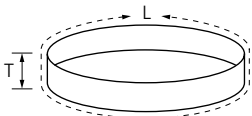

Aluminium oxide A compact grain version

Outstandingly suited to fine and very fine grinding, and for step-by-step preparations for polishing. The self-sharpening compact grain facilitates a very long tool life and achieves consistent surface quality levels throughout the entire tool life.

Special features:

- High economic efficiency due to high abrasive performance and long tool life.
- High tear strength with optimum flexibility.

- Consistent results through very good grain adhesion.

L [mm]	T [mm]	Abrasive	Grit size		Item no.	Designation	Price/unit EUR
533	30	A-CK	320	10	45020314	BA 30/533 J A 320 CK	-
610	30	A-CK	800	10	45020420	BA 30/610 J A 800 CK	-
			1000	10	45020422	BA 30/610 J A 1000 CK	-
760	40	A-CK	120	10	45000209	BA 40/760 A 120 CK	-
			180	10	45000210	BA 40/760 A 180 CK	-
			240	10	45000211	BA 40/760 A 240 CK	-
			320	10	45000212	BA 40/760 A 320 CK	-
			400	10	45000213	BA 40/760 A 400 CK	-
			600	10	45000214	BA 40/760 A 600 CK	-
820	40	A-CK	120	10	45000224	BA 40/820 A 120 CK	-
			180	10	45000225	BA 40/820 A 180 CK	-
			240	10	45000226	BA 40/820 A 240 CK	-
			320	10	45000227	BA 40/820 A 320 CK	-
			400	10	45000228	BA 40/820 A 400 CK	-
			600	10	45000229	BA 40/820 A 600 CK	-



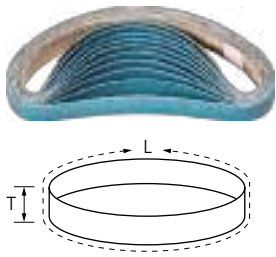

Zirconia alumina Z version

For coarse grinding work with a high stock removal rate and a long tool life.



Special features:

- High economic efficiency due to high abrasive performance and long tool life.
- High tear strength with optimum flexibility.
- Consistent results through very good grain adhesion.

L [mm]	T [mm]	Abrasive	Grit size	Acc. to ISO		Item no.	Designation	Price/unit EUR
330	10	Z	40	ISO 2976	100	45007904	BA 10/330 T Z 40	-
			60	ISO 2976	100	45007906	BA 10/330 T Z 60	-
	12	Z	60	-	100	45007926	BA 12/330 T Z 60	-
			80	-	100	45007928	BA 12/330 T Z 80	-
520	12	Z	40	-	100	45009104	BA 12/520 X Z 40	-
			60	-	100	45008106	BA 12/520 T Z 60	-
			80	-	100	45008108	BA 12/520 T Z 80	-
	20	Z	36	ISO 2976	20	45009402	BA 20/520 X Z 36	-
			40	ISO 2976	20	45009404	BA 20/520 X Z 40	-
			60	ISO 2976	20	45008406	BA 20/520 T Z 60	-
			80	ISO 2976	20	45009408	BA 20/520 T Z 80	-
			80	-	100	45009204	BA 12/610 X Z 40	-
610	12	Z	60	-	100	45008206	BA 12/610 T Z 60	-
			80	-	100	45008208	BA 12/610 T Z 80	-

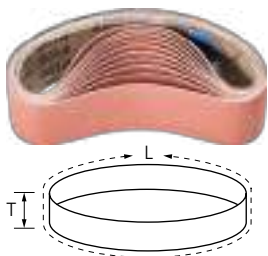

Aluminium oxide A-COOL version

For general grinding work from fine to very fine grinding on materials which do not conduct heat well, e.g. stainless steel (INOX). Active grinding additives substantially improve the stock removal rate, prevent clogging and result in cooler grinding.

Special features:

- High economic efficiency due to high abrasive performance and long tool life.
- High tear strength with optimum flexibility.
- Consistent results through very good grain adhesion.

L [mm]	T [mm]	Abrasive	Grit size	Acc. to ISO		Item no.	Designation	Price/unit EUR
450	50	A-COOL	40	ISO 2976	20	45007204	BA 50/450 A COOL 40	-
			80	ISO 2976	20	45007208	BA 50/450 A-COOL 80	-
			120	ISO 2976	20	45007212	BA 50/450 A-COOL 120	-
			180	ISO 2976	20	45007218	BA 50/450 A-COOL 180	-

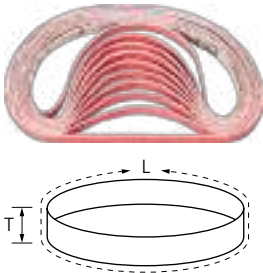

Ceramic oxide grain CO-COOL version

Consistently high performance and aggressive grinding due to self-sharpening ceramic oxide grain. Active grinding additives improve the stock removal rate, prevent clogging and result in cooler grinding on hard materials which do not conduct heat well.



Special features:

- High economic efficiency due to high abrasive performance and long tool life.
- High tear strength with optimum flexibility.
- Consistent results through very good grain adhesion.

L [mm]	T [mm]	Abrasive	Grit size	Acc. to ISO		Item no.	Designation	Price/ unit EUR
305	6	CO-COOL	40	-	100	45020001	BA 6/305 CO-COOL 40	-
			60	-	100	45020003	BA 6/305 CO-COOL 60	-
			80	-	100	45020004	BA 6/305 CO-COOL 80	-
			120	-	100	45020005	BA 6/305 CO-COOL 120	-
	9	CO-COOL	40	-	100	45020031	BA 9/305 CO-COOL 40	-
			60	-	100	45020033	BA 9/305 CO-COOL 60	-
			80	-	100	45020034	BA 9/305 CO-COOL 80	-
			120	-	100	45020035	BA 9/305 CO-COOL 120	-
	12	CO-COOL	40	-	100	45020051	BA 12/305 CO-COOL 40	-
			60	-	100	45020053	BA 12/305 CO-COOL 60	-
			80	-	100	45020054	BA 12/305 CO-COOL 80	-
			120	-	100	45020055	BA 12/305 CO-COOL 120	-
330	10	CO-COOL	40	ISO 2976	100	45020041	BA 10/330 CO-COOL 40	-
			60	ISO 2976	100	45020043	BA 10/330 CO-COOL 60	-
			80	ISO 2976	100	45020044	BA 10/330 CO-COOL 80	-
			120	ISO 2976	100	45020045	BA 10/330 CO-COOL 120	-
	12	CO-COOL	40	-	100	45020061	BA 12/330 CO-COOL 40	-
			60	-	100	45020063	BA 12/330 CO-COOL 60	-
			80	-	100	45020064	BA 12/330 CO-COOL 80	-
			120	-	100	45020065	BA 12/330 CO-COOL 120	-
450	35	CO-COOL	40	ISO 2976	20	45020171	BA 35/450 CO-COOL 40	-
			60	ISO 2976	20	45020173	BA 35/450 CO-COOL 60	-
			80	ISO 2976	20	45020174	BA 35/450 CO-COOL 80	-
			120	ISO 2976	20	45020175	BA 35/450 CO-COOL 120	-
	50	CO-COOL	40	ISO 2976	20	45020181	BA 50/450 CO-COOL 40	-
			60	ISO 2976	20	45020183	BA 50/450 CO-COOL 60	-
			80	ISO 2976	20	45020184	BA 50/450 CO-COOL 80	-
			120	ISO 2976	20	45020185	BA 50/450 CO-COOL 120	-
457	13	CO-COOL	40	ISO 2976	100	45020091	BA 13/457 CO-COOL 40	-
			60	ISO 2976	100	45020093	BA 13/457 CO-COOL 60	-
			80	ISO 2976	100	45020094	BA 13/457 CO-COOL 80	-
			120	ISO 2976	100	45020095	BA 13/457 CO-COOL 120	-
480	16	CO-COOL	40	-	50	45020101	BA 16/480 CO-COOL 40	-
			60	-	50	45020103	BA 16/480 CO-COOL 60	-
			80	-	50	45020104	BA 16/480 CO-COOL 80	-
			120	-	50	45020105	BA 16/480 CO-COOL 120	-
	20	CO-COOL	40	ISO 2976	20	45020121	BA 20/480 CO-COOL 40	-
			60	ISO 2976	20	45020123	BA 20/480 CO-COOL 60	-
			80	ISO 2976	20	45020124	BA 20/480 CO-COOL 80	-
			120	ISO 2976	20	45020125	BA 20/480 CO-COOL 120	-

Continued on next page



Flexible abrasives

Short belts BA



L [mm]	T [mm]	Abrasive	Grit size	Acc. to ISO		Item no.	Designation	Price/unit EUR
480	25	CO-COOL	40	ISO 2976	20	45020141	BA 25/480 CO-COOL 40	-
			60	ISO 2976	20	45020143	BA 25/480 CO-COOL 60	-
			80	ISO 2976	20	45020144	BA 25/480 CO-COOL 80	-
			120	ISO 2976	20	45020145	BA 25/480 CO-COOL 120	-
520	6	CO-COOL	40	ISO 2976	100	45020011	BA 6/520 CO-COOL 40	-
			60	ISO 2976	100	45020013	BA 6/520 CO-COOL 60	-
			80	ISO 2976	100	45020014	BA 6/520 CO-COOL 80	-
			120	ISO 2976	100	45020015	BA 6/520 CO-COOL 120	-
	12	CO-COOL	40	-	100	45020071	BA 12/520 CO-COOL 40	-
			60	-	100	45020073	BA 12/520 CO-COOL 60	-
			80	-	100	45020074	BA 12/520 CO-COOL 80	-
			120	-	100	45020075	BA 12/520 CO-COOL 120	-
	16	CO-COOL	40	-	50	45020111	BA 16/520 CO-COOL 40	-
			60	-	50	45020113	BA 16/520 CO-COOL 60	-
			80	-	50	45020114	BA 16/520 CO-COOL 80	-
			120	-	50	45020115	BA 16/520 CO-COOL 120	-
	20	CO-COOL	40	ISO 2976	20	45020131	BA 20/520 CO-COOL 40	-
			60	ISO 2976	20	45020133	BA 20/520 CO-COOL 60	-
			80	ISO 2976	20	45020134	BA 20/520 CO-COOL 80	-
			120	ISO 2976	20	45020135	BA 20/520 CO-COOL 120	-
533	30	CO-COOL	40	-	20	45020151	BA 30/533 CO-COOL 40	-
			60	-	20	45020153	BA 30/533 CO-COOL 60	-
			80	-	20	45020154	BA 30/533 CO-COOL 80	-
			120	-	20	45020155	BA 30/533 CO-COOL 120	-
610	6	CO-COOL	40	ISO 2976	100	45020021	BA 6/610 CO-COOL 40	-
			60	ISO 2976	100	45020023	BA 6/610 CO-COOL 60	-
			80	ISO 2976	100	45020024	BA 6/610 CO-COOL 80	-
			120	ISO 2976	100	45020025	BA 6/610 CO-COOL 120	-
	12	CO-COOL	40	-	100	45020081	BA 12/610 CO-COOL 40	-
			60	-	100	45020083	BA 12/610 CO-COOL 60	-
			80	-	100	45020084	BA 12/610 CO-COOL 80	-
			120	-	100	45020085	BA 12/610 CO-COOL 120	-
	30	CO-COOL	40	-	10	45020161	BA 30/610 CO-COOL 40	-
			60	-	10	45020163	BA 30/610 CO-COOL 60	-
			80	-	10	45020164	BA 30/610 CO-COOL 80	-
			120	-	10	45020165	BA 30/610 CO-COOL 120	-
760	40	CO-COOL	40	-	10	45000201	BA 40/760 CO-COOL 40	-
			60	-	10	45000202	BA 40/760 CO-COOL 60	-
			80	-	10	45000203	BA 40/760 CO-COOL 80	-
			120	-	10	45000204	BA 40/760 CO-COOL 120	-
820	40	CO-COOL	40	-	10	45000216	BA 40/820 CO-COOL 40	-
			60	-	10	45000217	BA 40/820 CO-COOL 60	-
			80	-	10	45000218	BA 40/820 CO-COOL 80	-
			120	-	10	45000219	BA 40/820 CO-COOL 120	-

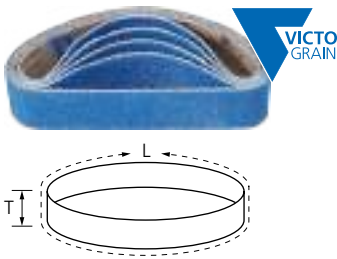

VICTOGRAIN-COOL version

For maximum aggressive grinding with an extremely long tool life, the ultimate stock removal rate and consistently high performance on steel and hard materials which do not conduct heat well. Active grinding additives in the coating prevent clogging and result in cooler grinding.



Special features:

- High economic efficiency due to high abrasive performance and long tool life.
- High tear strength with optimum flexibility.
- Consistent results through very good grain adhesion.

L [mm]	T [mm]	Abrasive	Grit size		Item no.	Designation	Price/unit EUR
450	50	VICTOGRAIN-COOL	36	10	45001175	BA 50/450 VICTOGRAIN-COOL 36	-
760	40	VICTOGRAIN-COOL	36	10	45000200	BA 40/760 VICTOGRAIN-COOL 36	-
820	40	VICTOGRAIN-COOL	36	10	45000215	BA 40/820 VICTOGRAIN-COOL 36	-



Short belts VB

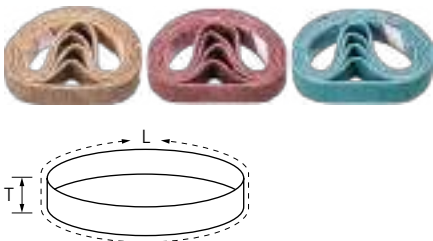

Non-woven version

Suitable for general work on surfaces such as metal tubular structures, e.g. removing rough grinding traces, removing oxidation and light deburring work. Achieve matt and satin-finished surfaces.



Special features:

- High economic efficiency due to high abrasive performance and long tool life.
- High tear strength with optimum flexibility.
- Consistent results through very good grain adhesion.

L [mm]	T [mm]	Abrasive	Grit size	Version	Acc. to ISO		Item no.	Designation	Price/unit EUR
305	6	A	100 G	coarse, yellow-brown	-	10	45010610	VB 6/305 A 100 G	-
			180 M	medium, red-brown	-	10	45010618	VB 6/305 A 180 M	-
			240 F	fine, blue	-	10	45010624	VB 6/305 A 240 F	-
	9	A	100 G	coarse, yellow-brown	-	10	45010710	VB 9/305 A 100 G	-
			180 M	medium, red-brown	-	10	45010718	VB 9/305 A 180 M	-
			240 F	fine, blue	-	10	45010724	VB 9/305 A 240 F	-
	12	A	100 G	coarse, yellow-brown	-	10	45010810	VB 12/305 A 100 G	-
			180 M	medium, red-brown	-	10	45010818	VB 12/305 A 180 M	-
			240 F	fine, blue	-	10	45010824	VB 12/305 A 240 F	-

Continued on next page

Flexible abrasives

Short belts VB



L [mm]	T [mm]	Abrasive	Grit size	Version	Acc. to ISO		Item no.	Designation	Price/ unit EUR
450	35	A	100 G	coarse, yellow-brown	-	10	45011410	VB 35/450 A 100 G	-
			180 M	medium, red-brown	-	10	45011418	VB 35/450 A 180 M	-
			240 F	fine, blue	-	10	45011424	VB 35/450 A 240 F	-
	50	A	100 G	coarse, yellow-brown	ISO 2976	10	45011510	VB 50/450 A 100 G	-
			180 M	medium, red-brown	ISO 2976	10	45011518	VB 50/450 A 180 M	-
			240 F	fine, blue	ISO 2976	10	45011524	VB 50/450 A 240 F	-
520	6	A	100 G	coarse, yellow-brown	-	10	45011010	VB 6/520 A 100 G	-
			180 M	medium, red-brown	-	10	45011018	VB 6/520 A 180 M	-
			240 F	fine, blue	-	10	45011024	VB 6/520 A 240 F	-
	12	A	100 G	coarse, yellow-brown	-	10	45011110	VB 12/520 A 100 G	-
			180 M	medium, red-brown	-	10	45011118	VB 12/520 A 180 M	-
			240 F	fine, blue	-	10	45011124	VB 12/520 A 240 F	-
	16	A	100 G	coarse, yellow-brown	-	10	45011210	VB 16/520 A 100 G	-
			180 M	medium, red-brown	-	10	45011218	VB 16/520 A 180 M	-
			240 F	fine, blue	-	10	45011224	VB 16/520 A 240 F	-
	20	A	100 G	coarse, yellow-brown	ISO 2976	5	45011310	VB 20/520 A 100 G	-
			180 M	medium, red-brown	ISO 2976	5	45011318	VB 20/520 A 180 M	-
			240 F	fine, blue	ISO 2976	5	45011324	VB 20/520 A 240 F	-
533	30	A	100 G	coarse, yellow-brown	ISO 2976	5	45010910	VB 30/533 A 100 G	-
			180 M	medium, red-brown	ISO 2976	5	45010918	VB 30/533 A 180 M	-
			240 F	fine, blue	ISO 2976	5	45010924	VB 30/533 A 240 F	-
610	6	A	100 G	coarse, yellow-brown	ISO 2976	10	45011810	VB 6/610 A 100 G	-
			180 M	medium, red-brown	ISO 2976	10	45011818	VB 6/610 A 180 M	-
			240 F	fine, blue	ISO 2976	10	45011824	VB 6/610 A 240 F	-
	12	A	100 G	coarse, yellow-brown	-	10	45011910	VB 12/610 A 100 G	-
			180 M	medium, red-brown	-	10	45011918	VB 12/610 A 180 M	-
			240 F	fine, blue	-	10	45011924	VB 12/610 A 240 F	-
	30	A	100 G	coarse, yellow-brown	-	5	45011350	VB 30/610 A 100 G	-
			180 M	medium, red-brown	-	5	45011351	VB 30/610 A 180 M	-
			240 F	fine, blue	-	5	45011352	VB 30/610 A 240 F	-
760	40	A	100 G	coarse, yellow-brown	-	5	45000230	VB 40/760 A 100 G	-
			180 M	medium, red-brown	-	5	45000231	VB 40/760 A 180 M	-
			240 F	fine, blue	-	5	45000232	VB 40/760 A 240 F	-
820	40	A	100 G	coarse, yellow-brown	-	5	45000234	VB 40/820 A 100 G	-

Continued on next page

L [mm]	T [mm]	Abrasive	Grit size	Version	Acc. to ISO		Item no.	Designation	Price/unit EUR
820	40	A	180 M	medium, red-brown	-	5	45000235	VB 40/820 A 180 M	-
			240 F	fine, blue	-	5	45000236	VB 40/820 A 240 F	-

Short belts P-BA

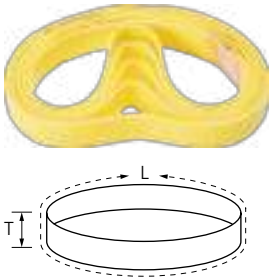

Felt version

Suitable for polishing with polishing paste bars and grinding pastes on tubular constructions and railings.



Special features:

- High economic efficiency due to long tool life.
- High tear strength with optimum flexibility.
- Consistent results through very good polishing agent adhesion.

L [mm]	T [mm]	Acc. to ISO		Item no.	Designation	Price/unit EUR
533	30	ISO 2976	5	45008501	P-BA 30/533	-
610	30	-	5	45008502	P-BA 30/610	-
760	40	-	5	45000233	P-BA 40/760	-
820	40	-	5	45000237	P-BA 40/820	-

Belts for pneumatic drums

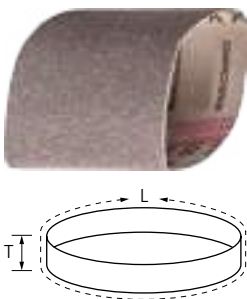

Aluminium oxide A compact grain version

Outstandingly suited to fine and very fine grinding, and for step-by-step preparations for polishing. The self-sharpening compact grain facilitates a very long tool life and achieves consistent surface quality levels throughout the entire tool life.

Special features:

- High economic efficiency due to high abrasive performance and long tool life.
- High tear strength with optimum flexibility.
- The rubber tube of the drum yields under higher contact pressure, meaning the abrasive belt adapts very well to the surface of the workpiece.

L [mm]	T [mm]	Abrasive	Grit size		Item no.	Designation	Price/unit EUR
282	100	A-CK	120	5	45001158	BA 100/282 A 120 CK	-
			180	5	45001160	BA 100/282 A 180 CK	-
			240	5	45001162	BA 100/282 A 240 CK	-
			320	5	45001164	BA 100/282 A 320 CK	-
			400	5	45001166	BA 100/282 A 400 CK	-
			600	5	45001168	BA 100/282 A 600 CK	-
			800	5	45001170	BA 100/282 A 800 CK	-
			1000	5	45001172	BA 100/282 A 1000 CK	-
1200	5	45001174	BA 100/282 A 1200 CK	-			



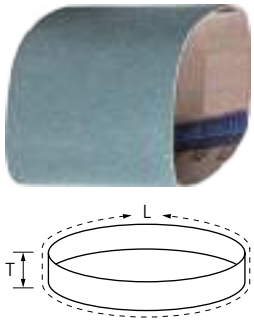

Zirconia alumina Z version

For coarse grinding work with a high stock removal rate and a long tool life.

Special features:

- High economic efficiency due to high abrasive performance and long tool life.
- High tear strength with optimum flexibility.
- The rubber tube of the drum yields under higher contact pressure, meaning the abrasive belt adapts very well to the surface of the workpiece.

L [mm]	T [mm]	Abrasive	Grit size		Item no.	Designation	Price/unit EUR
282	100	Z	40	5	45001152	BA 100/282 Z 40	-
			60	5	45001154	BA 100/282 Z 60	-
			80	5	45001156	BA 100/282 Z 80	-

4

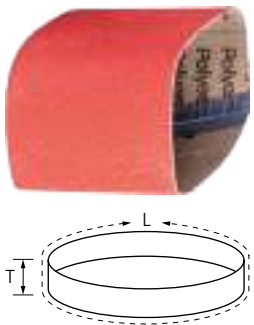

Ceramic oxide grain CO-COOL version

Consistently high performance and aggressive grinding due to self-sharpening ceramic oxide grain. Active grinding additives improve the stock removal rate, prevent clogging and result in cooler grinding on hard materials which do not conduct heat well.

Special features:

- High economic efficiency due to high abrasive performance and long tool life.
- High tear strength with optimum flexibility.
- The rubber tube of the drum yields under higher contact pressure, meaning the abrasive belt adapts very well to the surface of the workpiece.

L [mm]	T [mm]	Abrasive	Grit size		Item no.	Designation	Price/unit EUR
282	100	CO-COOL	40	5	45001150	BA 100/282 CO-COOL 40	-
			60	5	47501880	BA 100/282 CO-COOL 60	-
			80	5	47501885	BA 100/282 CO-COOL 80	-
			120	5	47501881	BA 100/282 CO-COOL 120	-

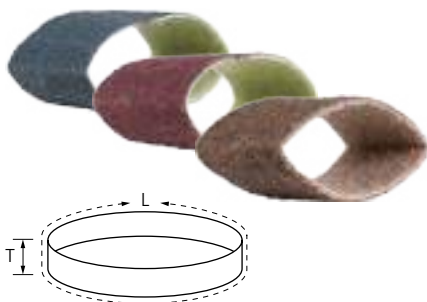

Non-woven version

Suitable for general work on surfaces such as metal structures, e.g. removing rough grinding traces, removing oxidation and light deburring work. Achieve matt and satin-finished surfaces.

Special features:

- High economic efficiency due to high abrasive performance and long tool life.
- High tear strength with optimum flexibility.
- The rubber tube of the drum yields under higher contact pressure, meaning the non-woven belt adapts very well to the surface of the workpiece.

L [mm]	T [mm]	Abrasive	Grit size	Version		Item no.	Designation	Price/unit EUR
282	100	A	100 G	coarse, yellow-brown	2	45011707	VB 100/282 A 100 G	-
			180 M	medium, red-brown	2	45011708	VB 100/282 A 180 M	-
			240 F	fine, blue	2	45011709	VB 100/282 A 240 F	-

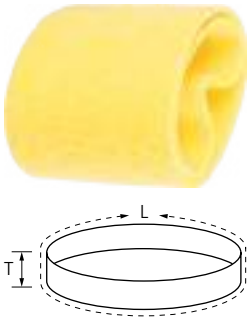

Felt version

Suitable for polishing with polishing paste bars and grinding pastes on large surfaces.

Special features:

- High economic efficiency through very good polishing agent adhesion.
- High tear strength with optimum flexibility.
- The rubber tube of the drum yields under higher contact pressure, meaning the polishing belt adapts very well to the surface of the workpiece.

L [mm]	T [mm]		Item no.	Designation	Price/unit EUR
282	100	2	45008503	P-BA 100/282	-

Pneumatic drum



Pneumatic drum

The pneumatic grinding drum is suitable for short belts with a width of 100 mm and a length of 282 mm. The rubber tube yields with increased contact pressure, which is why the abrasive belt adapts very well to the surface to be machined and the contact area increases.

Special features:

- High economic efficiency due to high abrasive performance and long tool life.
- The rubber tube of the drum yields under higher contact pressure, meaning the abrasive, non-woven or polishing belt adapts very well to the surface of the workpiece.

Suitable for short belts [mm]	D [mm]	T [mm]	H [mm]	Max. RPM		Item no.	Designation	Price/unit EUR
282 x 100	90	100	19	3,800	1	42100100	PSW 90x100	-

Long belts BA

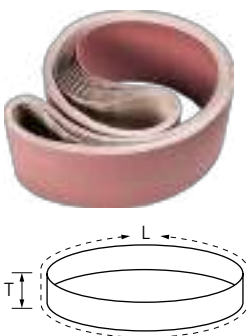

Aluminium oxide A version

For general applications from coarse to fine grinding.

Special features:

- High economic efficiency due to high abrasive performance and long tool life.
- High tear strength with optimum flexibility.
- Consistent results through very good grain adhesion.

L [mm]	T [mm]	Abrasive	Grit size	Acc. to ISO		Item no.	Designation	Price/unit EUR
1,000	50	A	60	ISO 2976	10	45005556	BA 50/1000 X A 60	-
			80	ISO 2976	10	45005558	BA 50/1000 X A 80	-
			120	ISO 2976	10	45005562	BA 50/1000 X A 120	-
	100	A	40	ISO 2976	10	45005904	BA 100/1000 X A 40	-
			60	ISO 2976	10	45005906	BA 100/1000 X A 60	-
			80	ISO 2976	10	45005908	BA 100/1000 X A 80	-
2,000	50	A	120	ISO 2976	10	45005912	BA 100/1000 X A 120	-
			40	ISO 2976	10	45005604	BA 50/2000 X A 40	-

Continued on next page



L [mm]	T [mm]	Abrasive	Grit size	Acc. to ISO		Item no.	Designation	Price/unit EUR
2,000	50	A	60	ISO 2976	10	45005606	BA 50/2000 X A 60	-
			80	ISO 2976	10	45005608	BA 50/2000 X A 80	-
			120	ISO 2976	10	45005612	BA 50/2000 X A 120	-
	75	A	36	ISO 2976	10	45005703	BA 75/2000 X A 36	-
			40	ISO 2976	10	45005704	BA 75/2000 X A 40	-
			60	ISO 2976	10	45005706	BA 75/2000 X A 60	-
			80	ISO 2976	10	45005708	BA 75/2000 X A 80	-
			120	ISO 2976	10	45005712	BA 75/2000 X A 120	-
	150	A	36	ISO 2976	10	45006003	BA 150/2000 X A 36	-
			40	ISO 2976	10	45006004	BA 150/2000 X A 40	-
			60	ISO 2976	10	45006006	BA 150/2000 X A 60	-
			80	ISO 2976	10	45006008	BA 150/2000 X A 80	-
2,500	75	A	36	ISO 2976	10	45005803	BA 75/2500 X A 36	-
			40	ISO 2976	10	45005804	BA 75/2500 X A 40	-
			60	ISO 2976	10	45005806	BA 75/2500 X A 60	-
			80	ISO 2976	10	45005808	BA 75/2500 X A 80	-
			120	ISO 2976	10	45005812	BA 75/2500 X A 120	-

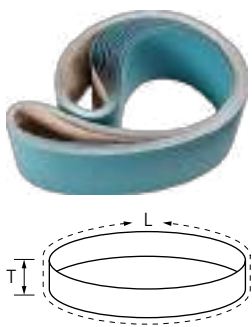

Zirconia alumina Z version

For coarse grinding work with a high stock removal rate and a long tool life.



Special features:

- High economic efficiency due to high abrasive performance and long tool life.
- High tear strength with optimum flexibility.
- Consistent results through very good grain adhesion.

L [mm]	T [mm]	Abrasive	Grit size	Acc. to ISO		Item no.	Designation	Price/unit EUR
1,000	100	Z	40	ISO 2976	10	45009804	BA 100/1000 X Z 40	-
			60	ISO 2976	10	45009806	BA 100/1000 X Z 60	-
			80	ISO 2976	10	45009808	BA 100/1000 X Z 80	-
			120	ISO 2976	10	45009812	BA 100/1000 X Z 120	-
2,000	50	Z	24	ISO 2976	10	45009502	BA 50/2000 X Z 24	-
			36	ISO 2976	10	45009503	BA 50/2000 X Z 36	-
			40	ISO 2976	10	45009504	BA 50/2000 X Z 40	-
			60	ISO 2976	10	45009506	BA 50/2000 X Z 60	-
			80	ISO 2976	10	45009508	BA 50/2000 X Z 80	-
			120	ISO 2976	10	45009512	BA 50/2000 X Z 120	-
	75	Z	24	ISO 2976	10	45009602	BA 75/2000 X Z 24	-
			36	ISO 2976	10	45009603	BA 75/2000 X Z 36	-
			40	ISO 2976	10	45009604	BA 75/2000 X Z 40	-
			60	ISO 2976	10	45009606	BA 75/2000 X Z 60	-
			80	ISO 2976	10	45009608	BA 75/2000 X Z 80	-
			120	ISO 2976	10	45009612	BA 75/2000 X Z 120	-
	150	Z	36	ISO 2976	10	45009903	BA 150/2000 X Z 36	-
			40	ISO 2976	10	45009904	BA 150/2000 X Z 40	-
			60	ISO 2976	10	45009906	BA 150/2000 X Z 60	-
			80	ISO 2976	10	45009908	BA 150/2000 X Z 80	-

Continued on next page

L [mm]	T [mm]	Abrasive	Grit size	Acc. to ISO		Item no.	Designation	Price/unit EUR
2,000	150	Z	120	ISO 2976	10	45009912	BA 150/2000 X Z 120	-
2,250	75	Z	40	ISO 2976	10	45009734	BA 75/2250 X Z 40	-
			60	ISO 2976	10	45009736	BA 75/2250 X Z 60	-
2,500	75	Z	36	ISO 2976	10	45009703	BA 75/2500 X Z 36	-
			40	ISO 2976	10	45009704	BA 75/2500 X Z 40	-
			60	ISO 2976	10	45009706	BA 75/2500 X Z 60	-
			80	ISO 2976	10	45009708	BA 75/2500 X Z 80	-
	150	Z	36	ISO 2976	10	45009936	BA 150/2500 X Z 36	-

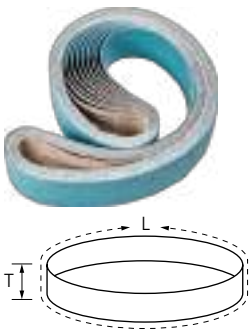

Zirconia alumina Z-FORTE version

For coarse grinding work with a high stock removal rate and long tool life and very cool grinding. Particularly suitable for work on thin-walled stainless steel (INOX) components and on steels or nickel-based alloys that do not conduct heat well.

Special features:

- High economic efficiency due to high abrasive performance and long tool life.
- High tear strength with optimum flexibility.
- Consistent results through very good grain adhesion.

L [mm]	T [mm]	Abrasive	Grit size	Acc. to ISO		Item no.	Designation	Price/unit EUR
2,000	75	Z-FORTE	36 FORTE	ISO 2976	10	45010063	BA 75/2000 X Z 36 FORTE	-
			40 FORTE	ISO 2976	10	45010064	BA 75/2000 X Z 40 FORTE	-
			60 FORTE	ISO 2976	10	45010066	BA 75/2000 X Z 60 FORTE	-
			80 FORTE	ISO 2976	10	45010068	BA 75/2000 X Z 80 FORTE	-
2,500	75	Z-FORTE	36 FORTE	ISO 2976	10	45010073	BA 75/2500 X Z 36 FORTE	-

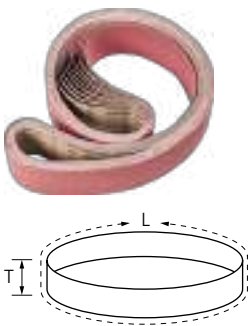

Ceramic oxide grain CO version

For aggressive grinding with maximum stock removal rate and very long tool life. Consistently high performance due to self-sharpening ceramic oxide grain. The ceramic oxide grain is specifically designed for work on hard materials and layers.



Special features:

- High economic efficiency due to high abrasive performance and long tool life.
- High tear strength with optimum flexibility.
- Consistent results through very good grain adhesion.

L [mm]	T [mm]	Abrasive	Grit size	Acc. to ISO		Item no.	Designation	Price/unit EUR
2,000	50	CO	24	ISO 2976	10	45005620	BA 50/2000 X CO 24	-
			36	ISO 2976	10	45005621	BA 50/2000 X CO 36	-
			40	ISO 2976	10	45005622	BA 50/2000 X CO 40	-
			50	ISO 2976	10	45005623	BA 50/2000 X CO 50	-
			60	ISO 2976	10	45005624	BA 50/2000 X CO 60	-
			80	ISO 2976	10	45005625	BA 50/2000 X CO 80	-
			120	ISO 2976	10	45005626	BA 50/2000 X CO 120	-
	75	CO	24	ISO 2976	10	45005720	BA 75/2000 X CO 24	-

Continued on next page



L [mm]	T [mm]	Abrasive	Grit size	Acc. to ISO		Item no.	Designation	Price/unit EUR
2,000	75	CO	36	ISO 2976	10	45005721	BA 75/2000 X CO 36	-
			40	ISO 2976	10	45005722	BA 75/2000 X CO 40	-
			50	ISO 2976	10	45005723	BA 75/2000 X CO 50	-
			60	ISO 2976	10	45005724	BA 75/2000 X CO 60	-
			80	ISO 2976	10	45005725	BA 75/2000 X CO 80	-
			120	ISO 2976	10	45005726	BA 75/2000 X CO 120	-
2,500	75	CO	24	ISO 2976	10	45005815	BA 75/2500 X CO 24	-
			36	ISO 2976	10	45005816	BA 75/2500 X CO 36	-
			40	ISO 2976	10	45005817	BA 75/2500 X CO 40	-
			50	ISO 2976	10	45005818	BA 75/2500 X CO 50	-
			60	ISO 2976	10	45005819	BA 75/2500 X CO 60	-
			80	ISO 2976	10	45005820	BA 75/2500 X CO 80	-
			120	ISO 2976	10	45005821	BA 75/2500 X CO 120	-

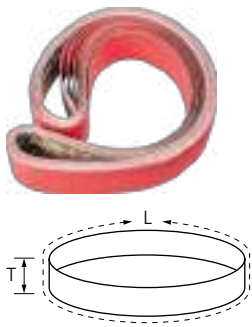

Ceramic oxide grain CO-COOL version

Consistently high performance and aggressive grinding due to self-sharpening ceramic oxide grain. Active grinding additives improve the stock removal rate, prevent clogging and result in cooler grinding on hard materials which do not conduct heat well.



Special features:

- High economic efficiency due to high abrasive performance and long tool life.
- High tear strength with optimum flexibility.
- Consistent results through very good grain adhesion.

L [mm]	T [mm]	Abrasive	Grit size	Acc. to ISO		Item no.	Designation	Price/unit EUR
2,000	50	CO-COOL	36	ISO 2976	10	45005631	BA 50/2000 X CO-COOL 36	-
			40	ISO 2976	10	45005632	BA 50/2000 X CO-COOL 40	-
			50	ISO 2976	10	45005633	BA 50/2000 X CO-COOL 50	-
			60	ISO 2976	10	45005634	BA 50/2000 X CO-COOL 60	-
			80	ISO 2976	10	45005635	BA 50/2000 X CO-COOL 80	-
			120	ISO 2976	10	45005636	BA 50/2000 X CO-COOL 120	-
	75	CO-COOL	36	ISO 2976	10	45005731	BA 75/2000 X CO-COOL 36	-
			40	ISO 2976	10	45005732	BA 75/2000 X CO-COOL 40	-
			50	ISO 2976	10	45005733	BA 75/2000 X CO-COOL 50	-
			60	ISO 2976	10	45005734	BA 75/2000 X CO-COOL 60	-
			80	ISO 2976	10	45005735	BA 75/2000 X CO-COOL 80	-
			120	ISO 2976	10	45005736	BA 75/2000 X CO-COOL 120	-
2,500	75	CO-COOL	36	ISO 2976	10	45005825	BA 75/2500 X CO-COOL 36	-
			40	ISO 2976	10	45005826	BA 75/2500 X CO-COOL 40	-
			50	ISO 2976	10	45005827	BA 75/2500 X CO-COOL 50	-
			60	ISO 2976	10	45005828	BA 75/2500 X CO-COOL 60	-
			80	ISO 2976	10	45005829	BA 75/2500 X CO-COOL 80	-
			120	ISO 2976	10	45005830	BA 75/2500 X CO-COOL 120	-

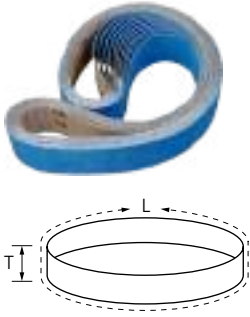

VICTOGRAIN-COOL version

For maximum aggressive grinding with an extremely long tool life, the ultimate stock removal rate and consistently high performance on steel and hard materials which do not conduct heat well. Active grinding additives in the coating prevent clogging and result in cooler grinding.

Special features:

- High economic efficiency due to high abrasive performance and long tool life.
- High tear strength with optimum flexibility.
- Consistent results through very good grain adhesion.

L [mm]	T [mm]	Abrasive	Grit size	Acc. to ISO		Item no.	Designation	Price/unit EUR
2,000	50	VICTOGRAIN-COOL	36	ISO 2976	10	45005637	BA 50/2000 VICTOGRAIN-COOL 36	-
	75	VICTOGRAIN-COOL	36	ISO 2976	10	45005638	BA 75/2000 VICTOGRAIN-COOL 36	-
2,500	75	VICTOGRAIN-COOL	36	ISO 2976	10	45005639	BA 75/2500 VICTOGRAIN-COOL 36	-



Non-woven version

Suitable for general work on metal surfaces in stationary applications, e.g. removing rough grinding traces, removing oxidation and light deburring work. Achieve matt and satin-finished surfaces.

Special features:

- High economic efficiency due to high abrasive performance and long tool life.
- High tear strength with optimum flexibility.
- Consistent results through very good grain adhesion.

L [mm]	T [mm]	Abrasive	Grit size	Version		Item no.	Designation	Price/unit EUR
2,000	75	A	100 G	coarse, yellow-brown	2	45011701	VB 75/2000 A 100 G	-
			180 M	medium, red-brown	2	45011702	VB 75/2000 A 180 M	-
			240 F	fine, blue	2	45011703	VB 75/2000 A 240 F	-
2,500	75	A	100 G	coarse, yellow-brown	2	45011704	VB 75/2500 A 100 G	-
			180 M	medium, red-brown	2	45011705	VB 75/2500 A 180 M	-
			240 F	fine, blue	2	45011706	VB 75/2500 A 240 F	-



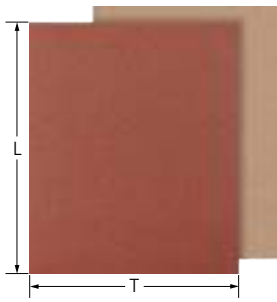

Aluminium oxide A, brown BR type

The brown cloth-backed variant is suitable for general, heavy-duty use on alloyed and non-alloyed steels, as well as non-ferrous metals.



Special features:

- Very good grain adhesion on very flexible cloth.
- High abrasive performance.
- Oil and kerosene-resistant.

L [mm]	T [mm]	Abrasive	Grit size		Item no.	Designation	Price/unit EUR
280	230	A	40	50	45013004	BG BR 230x280 A 40	-
			60	50	45013006	BG BR 230x280 A 60	-
			80	50	45013008	BG BR 230x280 A 80	-
			100	50	45013010	BG BR 230x280 A 100	-
			120	50	45013012	BG BR 230x280 A 120	-
			150	50	45013015	BG BR 230x280 A 150	-
			180	50	45013018	BG BR 230x280 A 180	-
			220	50	45013022	BG BR 230x280 A 220	-
			240	50	45013024	BG BR 230x280 A 240	-
			280	50	45013028	BG BR 230x280 A 280	-
			320	50	45013032	BG BR 230x280 A 320	-
			400	50	45013040	BG BR 230x280 A 400	-
			444	50	45013044	BG BR 230x280 A 444	-
			999	50	45013099	BG BR 230x280 A 999	-

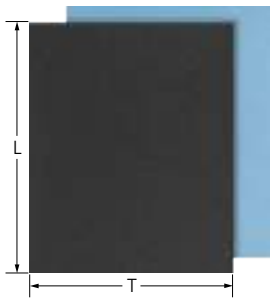

Aluminium oxide A, blue BL type

The blue cloth-backed variant is the low-cost alternative for normal workloads when working on painted wooden and metal surfaces.



Special features:

- Good grain adhesion on sturdy cloth.
- Good abrasive performance.

L [mm]	T [mm]	Abrasive	Grit size		Item no.	Designation	Price/unit EUR
280	230	A	40	50	45012004	BG BL 230x280 A 40	-
			60	50	45012006	BG BL 230x280 A 60	-
			80	50	45012008	BG BL 230x280 A 80	-
			100	100	45012010	BG BL 230x280 A 100	-
			120	100	45012012	BG BL 230x280 A 120	-
			150	100	45012015	BG BL 230x280 A 150	-
			180	100	45012018	BG BL 230x280 A 180	-
			220	100	45012022	BG BL 230x280 A 220	-
			240	100	45012024	BG BL 230x280 A 240	-

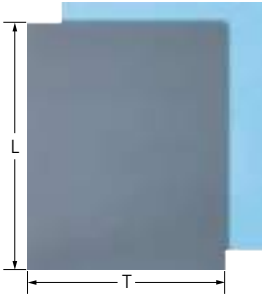

SiC version, waterproof W

The abrasive material SiC is suitable for use on paint and glass. Particularly suitable for all wet grinding work on conventional painted constructions.

Special features:

- Very good grain adhesion on very flexible and light paper.
- Maximum abrasive performance.
- Can be used for wet and dry grinding.

L [mm]	T [mm]	Abrasive	Grit size		Item no.	Designation	Price/unit EUR
280	230	SiC	100	50	45014010	BP W 230x280 SiC 100	-
			120	50	45014012	BP W 230x280 SiC 120	-
			150	50	45014015	BP W 230x280 SiC 150	-
			180	50	45014018	BP W 230x280 SiC 180	-
			220	50	45015022	BP W 230x280 SiC 220	-
			240	50	45015024	BP W 230x280 SiC 240	-
			280	50	45015028	BP W 230x280 SiC 280	-
			320	50	45015032	BP W 230x280 SiC 320	-
			360	50	45015036	BP W 230x280 SiC 360	-
			400	50	45015040	BP W 230x280 SiC 400	-
			500	50	45015050	BP W 230x280 SiC 500	-
			600	50	45015060	BP W 230x280 SiC 600	-
			800	50	45015080	BP W 230x280 SiC 800	-
			1000	50	45015100	BP W 230x280 SiC 1000	-
1200	50	45015120	BP W 230x280 SiC 1200	-			



Aluminium oxide A version

The abrasive material aluminium oxide A is the low-cost alternative for normal workloads when working on painted wooden and metal surfaces.

Special features:

- Good grain adhesion on sturdy paper.
- Good abrasive performance.

L [mm]	T [mm]	Abrasive	Grit size		Item no.	Designation	Price/unit EUR
280	230	A	40	50	45015204	BP 230x280 A 40	-
			60	50	45015206	BP 230x280 A 60	-
			80	50	45015208	BP 230x280 A 80	-
			100	100	45015210	BP 230x280 A 100	-
			120	100	45015212	BP 230x280 A 120	-
			150	100	45015215	BP 230x280 A 150	-
			180	100	45015218	BP 230x280 A 180	-
			220	100	45015222	BP 230x280 A 220	-
			240	100	45015224	BP 230x280 A 240	-
			280	100	45015228	BP 230x280 A 280	-
400	100	45015240	BP 230x280 A 400	-			



POLINOX hand pads PVSX

Suitable for very fine grinding on small to large surfaces and contours, and for manually cleaning metal and painted surfaces. Achieve matt and satin-finished surfaces. Highly open structure. Available in the aluminium oxide A and silicon carbide SiC types.



Special features:

- Highly flexible, enabling optimal adjustment to the contour.
- Hard-to-reach areas can be accessed.

L [mm]	T [mm]	Abrasive	Grit size		Item no.	Designation	Price/unit EUR
225	150	A	80	10	44697108	PVSK 150 A 80	-
			100	10	44697110	PVSK 150 A 100	-
			180	10	44697118	PVSK 150 A 180	-
			280	10	44697128	PVSK 150 A 280	-
		SiC	400	10	44697640	PVSK 150 SiC 400	-

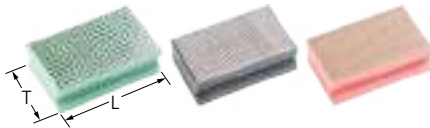

HP diamond type

Excellent for work on wear-resistant coatings and for hard facings. Particularly recommended for work on materials used for aircraft engine construction. Also ideal for work on extremely hard materials.

Special features:

- Highly flexible, enabling optimal adjustment to the contour. Hard-to-reach areas can be accessed.
- Can be used for wet and dry grinding.
- Colour code: D 251 (green) = P 60; D 126 (black) = P 120; D 76 (red) = P 200.

L [m]	T [mm]	Abrasive	Grit size [µm]		Item no.	Designation	Price/unit EUR
90	55	DIA	251	1	44696011	HP 5590 DIA 251	-
			126	1	44696012	HP 5590 DIA 126	-
			76	1	44696013	HP 5590 DIA 76	-

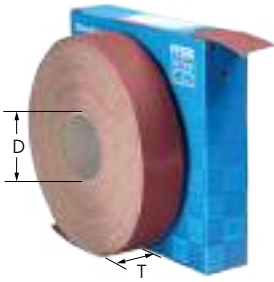

Cloth, aluminium oxide A type

The cloth-backed variant is suitable for general, heavy-duty use on alloyed and non-alloyed steels, as well as non-ferrous metals. The carton has a tear-off edge for separating the sections of abrasive belt at the workplace.



Special features:

- Highly flexible, enabling optimal adjustment to the contour.
- Little wear due to high tear strength and very good grain adhesion.
- Please order matching shop roll holder separately.

T [mm]	Length [m]	D [mm]	Abrasive	Grit size		Item no.	Designation	Price/unit EUR
25	50	75	A	60	1	45016006	SBR 25 A 60	-
				80	1	45016008	SBR 25 A 80	-
				100	1	45016010	SBR 25 A 100	-
				120	1	45016012	SBR 25 A 120	-
				150	1	45016015	SBR 25 A 150	-
				180	1	45016018	SBR 25 A 180	-
				240	1	45016024	SBR 25 A 240	-
				320	1	45016032	SBR 25 A 320	-
				400	1	45016040	SBR 25 A 400	-
				600	1	45016060	SBR 25 A 600	-
800	1	45016080	SBR 25 A 800	-				
38	25	75	A	40	1	45016404	SBR 38 A 40	-
				50	1	45016405	SBR 38 A 50	-
				60	1	45016406	SBR 38 A 60	-
				80	1	45016408	SBR 38 A 80	-
				100	1	45016410	SBR 38 A 100	-
				120	1	45016412	SBR 38 A 120	-
				150	1	45016415	SBR 38 A 150	-
				180	1	45016418	SBR 38 A 180	-
				220	1	45016422	SBR 38 A 220	-
				240	1	45016424	SBR 38 A 240	-
40	50	75	A	40	1	45016104	SBR 40 A 40	-
				60	1	45016106	SBR 40 A 60	-
				80	1	45016108	SBR 40 A 80	-
				100	1	45016110	SBR 40 A 100	-
				120	1	45016112	SBR 40 A 120	-
				150	1	45016115	SBR 40 A 150	-
				180	1	45016118	SBR 40 A 180	-
				220	1	45016122	SBR 40 A 220	-
				240	1	45016124	SBR 40 A 240	-
				320	1	45016132	SBR 40 A 320	-
50	50	75	A	40	1	45016204	SBR 50 A 40	-
				60	1	45016206	SBR 50 A 60	-
				80	1	45016208	SBR 50 A 80	-
				100	1	45016210	SBR 50 A 100	-
				120	1	45016212	SBR 50 A 120	-
				150	1	45016215	SBR 50 A 150	-

Continued on next page

T [mm]	Length [m]	D [mm]	Abrasive	Grit size		Item no.	Designation	Price/unit EUR
50	50	75	A	180	1	45016218	SBR 50 A 180	-
				220	1	45016220	SBR 50 A 220	-
				240	1	45016224	SBR 50 A 240	-
				320	1	45016232	SBR 50 A 320	-
				400	1	45016240	SBR 50 A 400	-
				600	1	45016260	SBR 50 A 600	-
100	50	75	A	40	1	45016304	SBR 100 A 40	-
				60	1	45016306	SBR 100 A 60	-
				80	1	45016308	SBR 100 A 80	-
				100	1	45016310	SBR 100 A 100	-
				120	1	45016312	SBR 100 A 120	-
				150	1	45016315	SBR 100 A 150	-
				180	1	45016318	SBR 100 A 180	-
				240	1	45016324	SBR 100 A 240	-
				320	1	45016332	SBR 100 A 320	-
				400	1	45016340	SBR 100 A 400	-

4

Shop rolls SBR-P

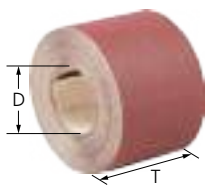

Paper, aluminium oxide A type

The abrasive material aluminium oxide A is the low-cost alternative for normal workloads when working on painted wooden and metal surfaces.



Special features:

- Highly flexible, enabling optimal adjustment to the contour.
- Little wear due to high tear strength and very good grain adhesion.

T [mm]	Length [m]	D [mm]	Abrasive	Grit size		Item no.	Designation	Price/unit EUR
115	25	75	A	40	1	45016534	SBR-P 115 A 40	-
				60	1	45016536	SBR-P 115 A 60	-
				80	1	45016538	SBR-P 115 A 80	-
				100	1	45016540	SBR-P 115 A 100	-
				120	1	45016542	SBR-P 115 A 120	-
				150	1	45016545	SBR-P 115 A 150	-

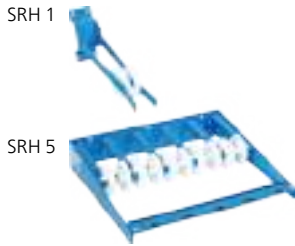

SRH 1 and SRH 5 types

Holder for wall mounting: for storing and tearing off to the required length as necessary. With the variant SRH 5, various roll sizes can be combined with each other as desired.

Special features:

- Enable shop rolls to be stored correctly.

Number of rolls	Suitable for roll width [mm]	Suitable for roll diameter [mm]		Item no.	Designation	Price/unit EUR
1	25, 38, 40, 50	380	1	42990001	SRH 1	-
5	25, 38, 40, 50	260	1	42990007	SRH 5	-

POLINOX non-woven shop rolls VBR

Aluminium oxide A and silicon carbide SiC types

Suitable for very fine grinding on small to large surfaces and contours, and for manually cleaning metal and painted surfaces. Achieve matt and satin-finished surfaces. Highly open structure.



Special features:

- Highly flexible, enabling optimal adjustment to the contour.
- Hard-to-reach areas can be accessed.

T [mm]	Length [m]	Abrasive	Grit size		Item no.	Designation	Price/unit EUR
100	10	A	80	1	45018308	VBR 100 A 80	-
			100	1	45018310	VBR 100 A 100	-
			180	1	45018318	VBR 100 A 180	-
			280	1	45018328	VBR 100 A 280	-
		SiC	400	1	45018440	VBR 100 SiC 400	-



Flexible abrasives

Abrasive cord



SS type

High flexibility, therefore ideal for very fine deburring and finishing work in hard-to-reach places. Especially recommended for work on very small holes, grooves and cut-outs in tool and mould-making. Available in aluminium oxide A and silicon carbide SiC.



Special features:

- Highly flexible, enabling optimal adjustment to the contour.
- Little wear due to high tear strength and very good grain adhesion.
- The abrasive cord can be shortened to the required length.

D [mm]	Length [m]	Abrasive	Grit size		Item no.	Designation	Price/unit EUR
0.8	15	A	200	1	45019002	SS 0.8 mm x 15 m A 200	-
1	15	A	180	1	45019003	SS 1,0mm x 15m A 180	-
1.4	15	A	150	1	45019004	SS 1.4 mm x 15 m A 150	-
1.8	15	A	180	1	45019005	SS 1.8 mm x 15 m A 180	-
2.1	15	A	120	1	45019006	SS 2.1 mm x 15 m A 120	-
0.5	15	SiC	200	1	45019001	SS 0.5 mm x 15 m SiC 200	-

Velcro-backed abrasive discs KSS

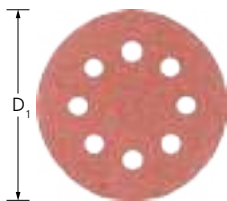

Aluminium oxide A version

Velcro-backed abrasive discs are suitable for fine grinding large surfaces with eccentric orbital sanders and for general use on metal, wood, plastic and paint. For general grinding work from coarse to fine grinding in industry and professional trades.

Special features:

- High economic efficiency thanks to quick tool-changing and high grinding performance.
- Maximum tool life through reduced clogging.

D ₁ [mm]	Holes	Abrasive	Grit size		Item no.	Designation	Price/unit EUR
125	-	A	40	25	45017760	KSS 125 O LA 40	-
			60	25	45017761	KSS 125 O LA 60	-
			80	25	45017762	KSS 125 O LA 80	-
			100	25	45017763	KSS 125 O LA 100	-
			120	25	45017764	KSS 125 O LA 120	-
			150	25	45017765	KSS 125 O LA 150	-
	8	A	40	25	45017004	KSS 125 8 LA 40	-
			60	25	45017006	KSS 125 8 LA 60	-
			80	25	45017008	KSS 125 8 LA 80	-
			100	25	45017010	KSS 125 8 LA 100	-
			120	25	45017012	KSS 125 8 LA 120	-
			150	25	45017015	KSS 125 8 LA 150	-
			180	25	45017018	KSS 125 8 LA 180	-
			240	25	45017024	KSS 125 8 LA 240	-
150	-	A	40	25	45017770	KSS 150 O LA 40	-
			60	25	45017771	KSS 150 O LA 60	-
			80	25	45017772	KSS 150 O LA 80	-

Continued on next page

D ₁ [mm]	Holes	Abrasive	Grit size		Item no.	Designation	Price/unit EUR
150	-	A	100	25	45017773	KSS 150 O L A 100	-
			120	25	45017774	KSS 150 O L A 120	-
			150	25	45017775	KSS 150 O L A 150	-
			180	25	45017776	KSS 150 O L A 180	-
			240	25	45017777	KSS 150 O L A 240	-
	6	A	40	25	45017104	KSS 150 6 L A 40	-
			60	25	45017106	KSS 150 6 L A 60	-
			80	25	45017108	KSS 150 6 L A 80	-
			100	25	45017110	KSS 150 6 L A 100	-
			120	25	45017112	KSS 150 6 L A 120	-
			150	25	45017115	KSS 150 6 L A 150	-
			180	25	45017118	KSS 150 6 L A 180	-
			240	25	45017124	KSS 150 6 L A 240	-
			320	25	45017132	KSS 150 6 L A 320	-
			400	25	45017140	KSS 150 6 L A 400	-
			8	A	40	25	45017144
	60	25			45017146	KSS 150 8 L A 60	-
	80	25			45017148	KSS 150 8 L A 80	-
	100	25			45017150	KSS 150 8 L A 100	-
	120	25			45017152	KSS 150 8 L A 120	-
	150	25			45017155	KSS 150 8 L A 150	-



Velcro-backed abrasive discs KSS-NET



Aluminium oxide A version

NET Velcro-backed abrasive discs consist of a netting fabric to which the abrasive grit is stuck using a powerful binding technique, which makes it very robust. For dust-free, general grinding work on medium-sized and large surfaces.



Special features:

- Very long tool life and high stock removal rate.
- Achieves very fine, even surfaces. Dust-free work thanks to good extraction capability.
- Durable netting structure with high tear strength and edge stability.

D ₁ [mm]	Abrasive	Grit size		Item no.	Designation	Price/unit EUR
125	A	80	25	45018001	KSS NET 125 A 80	-
		100	25	45018002	KSS NET 125 A 100	-
		120	25	45018003	KSS NET 125 A 120	-
		150	25	45018004	KSS NET 125 A 150	-
		180	25	45018005	KSS NET 125 A 180	-
		240	25	45018006	KSS NET 125 A 240	-
		320	25	45018007	KSS NET 125 A 320	-
		400	25	45018008	KSS NET 125 A 400	-
		600	25	45018009	KSS NET 125 A 600	-
		800	25	45018010	KSS NET 125 A 800	-
		1000	25	45018011	KSS NET 125 A 1000	-
150	A	80	25	45018012	KSS NET 150 A 80	-

Continued on next page

Flexible abrasives

Velcro-backed abrasive discs KSS-NET



D ₁ [mm]	Abrasive	Grit size		Item no.	Designation	Price/unit EUR
150	A	100	25	45018013	KSS NET 150 A 100	-
		120	25	45018014	KSS NET 150 A 120	-
		150	25	45018015	KSS NET 150 A 150	-
		180	25	45018016	KSS NET 150 A 180	-
		240	25	45018017	KSS NET 150 A 240	-
		320	25	45018018	KSS NET 150 A 320	-
		400	25	45018019	KSS NET 150 A 400	-
		600	25	45018020	KSS NET 150 A 600	-
		800	25	45018021	KSS NET 150 A 800	-
		1000	25	45018022	KSS NET 150 A 1000	-

Velcro-backed abrasive disc holder

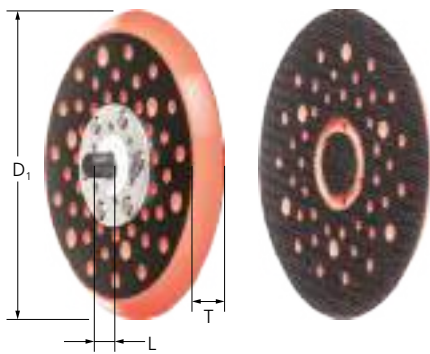

Velcro-backed abrasive disc holder

The holder is suitable for general use with various different eccentric orbital sanders with 5/16" thread. When used with NET Velcro-backed abrasive discs, this backing pad has particular advantages.

Special features:

- Clean, low-dust working environment. Suitable for general use due to multiple holes.
- Compatible with a lot of eccentric orbital sanders and self-adhesive discs.
- Extremely strong, durable self-adhesive system.

D ₁ [mm]	T [mm]	L [mm]	Thread	Suitable for Velcro-backed abrasive disc diameter [mm]		Item no.	Designation	Price/unit EUR
125	10	9	5/16-24 UNF	125	1	45017778	KSS-H 125-5/16	-
150	10	9	5/16-24 UNF	150	1	45017779	KSS-H 150-5/16	-

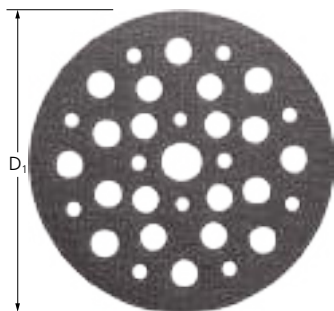

Protective pad for Velcro-backed abrasive disc holders

The protective pad protects the backing pad against premature wear and can be used with any type of Velcro-backed abrasive disc pad. The series of holes in the protective pads for Velcro-backed abrasive disc holders enables the grinding dust to be extracted very effectively.

Special features:

- Clean, low-dust working environment. Suitable for general use due to multiple holes.
- Compatible with a lot of eccentric orbital sanders, Velcro-backed abrasive disc holders and self-adhesive discs.
- Extremely strong, durable self-adhesive system.

D ₁ [mm]	Suitable for Velcro-backed abrasive disc diameter [mm]		Item no.	Designation	Price/unit EUR
125	125	5	45017780	KSS-PP 125	-
150	150	5	45017781	KSS-PP 150	-

The quick way to find the perfect tool

Material group ▼			Abrasive ▶				
			Aluminium oxide A	Zirconia alumina Z	Zirconia alumina Z-COOL	Ceramic oxide grain CO-COOL	Silicon carbide SiC
Steel, cast steel	Non-hardened, non-heat-treated steels	Construction steels, carbon steels, tool steels, non-alloyed steels, cast steel	●	○		●	
	Hardened, heat-treated steels	Tool steels, tempering steels, alloyed steels, cast steel	○	●		●	
Stainless steel (INOX)	Rust and acid-resistant steels	Austenitic and ferritic stainless steels		○	●	●	
Non-ferrous metals	Soft non-ferrous metals, non-ferrous metals	Soft aluminium alloys	○		○	○	
		Brass, copper, zinc	●	○	○		
	Hard non-ferrous metals	Hard aluminium alloys	●	○	○		○
		Bronze, titanium		○	●	●	●
	High-temperature-resistant materials	Nickel-based and cobalt-based alloys		○	●	●	
Cast iron	Grey cast iron, white cast iron	Cast iron with flake graphite EN-GJL (GG), with nodular graphite/nodular cast iron EN-GJS (GGG), white annealed cast iron EN-GJMW (GTW), black annealed cast iron EN-GJMB (GTS)	●	○			
Plastics, other materials		Fibre-reinforced plastics, thermoplastics, wood, chipboard, paint	●				●

● = highly suitable ○ = suitable

Safety notes

- The maximum permitted peripheral speed is 30 m/s.
- For safety reasons, the maximum permitted rotational speed indicated must never be exceeded.
- Do not allow abrasive spiral bands to protrude beyond the rubber drum holder.



Wear eye protection!



Wear hearing protection!



Wear gloves!



Wear a dust mask!



Follow the safety instructions!



Abrasive spiral bands

Small pack KSB

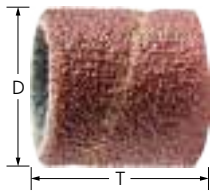

Aluminium oxide A version

For general applications from coarse to fine grinding.



Special features:

- The abrasive spiral band is firmly held in place on the rubber drum holder as the holder expands during use. The rubber drum holder must be ordered separately.
- Outstanding tool life due to special manufacturing process – even under the most demanding operating conditions.
- Maximum economic efficiency thanks to particularly high stock removal rate and aggressive abrasive quality.

D [mm]	T [mm]	Abrasive	Grit size	Opt. RPM		Item no.	Designation	Price/unit EUR
Cylindrical shape								
10	10	A	80	30,000 – 44,000	25	42231108	KSB 1010 A 80	-
			150	30,000 – 44,000	25	42231115	KSB 1010 A 150	-
	20	A	80	30,000 – 44,000	25	42232108	KSB 1020 A 80	-
			150	30,000 – 44,000	25	42232115	KSB 1020 A 150	-
13	10	A	80	30,000 – 44,000	25	42233108	KSB 1310 A 80	-
			150	30,000 – 44,000	25	42233115	KSB 1310 A 150	-
	25	A	80	30,000 – 44,000	25	42234108	KSB 1325 A 80	-
			150	30,000 – 44,000	25	42234115	KSB 1325 A 150	-
15	10	A	60	26,000 – 36,000	25	42235105	KSB 1510 A 60	-
			80	26,000 – 36,000	25	42235108	KSB 1510 A 80	-
			150	26,000 – 36,000	25	42235115	KSB 1510 A 150	-
	30	A	50	26,000 – 36,000	25	42236103	KSB 1530 A 50	-
			60	26,000 – 36,000	25	42236105	KSB 1530 A 60	-
			80	26,000 – 36,000	25	42236108	KSB 1530 A 80	-
			150	26,000 – 36,000	25	42236115	KSB 1530 A 150	-
			240	26,000 – 36,000	25	42236124	KSB 1530 A 240	-
19	25	A	60	20,000 – 30,000	25	42236505	KSB 1925 A 60	-
			80	20,000 – 30,000	25	42236508	KSB 1925 A 80	-
			150	20,000 – 30,000	25	42236515	KSB 1925 A 150	-
			240	20,000 – 30,000	25	42236524	KSB 1925 A 240	-
22	20	A	50	18,000 – 26,000	25	42237104	KSB 2220 A 50	-
			60	18,000 – 26,000	25	42237105	KSB 2220 A 60	-
			80	18,000 – 26,000	25	42237108	KSB 2220 A 80	-
			150	18,000 – 26,000	25	42237115	KSB 2220 A 150	-
25	25	A	60	16,000 – 22,900	25	42237505	KSB 2525 A 60	-
			80	16,000 – 22,900	25	42237508	KSB 2525 A 80	-
			150	16,000 – 22,900	25	42237515	KSB 2525 A 150	-
30	20	A	40	13,000 – 19,100	25	42238104	KSB 3020 A 40	-
			60	13,000 – 19,100	25	42238105	KSB 3020 A 60	-
			80	13,000 – 19,100	25	42238108	KSB 3020 A 80	-
			150	13,000 – 19,100	25	42238115	KSB 3020 A 150	-
	30	A	40	13,000 – 19,100	25	42239104	KSB 3030 A 40	-
			50	13,000 – 19,100	25	42239103	KSB 3030 A 50	-
			60	13,000 – 19,100	25	42239105	KSB 3030 A 60	-
			80	13,000 – 19,100	25	42239108	KSB 3030 A 80	-
38	25	A	40	10,000 – 15,900	25	42239504	KSB 3825 A 40	-
			60	10,000 – 15,900	25	42239505	KSB 3825 A 60	-
			80	10,000 – 15,900	25	42239508	KSB 3825 A 80	-
			150	10,000 – 15,900	25	42239515	KSB 3825 A 150	-

Continued on next page

D [mm]	T [mm]	Abrasive	Grit size	Opt. RPM		Item no.	Designation	Price/unit EUR
45	30	A	40	8,500 – 12,700	10	42240104	KSB 4530 A 40	-
			50	8,500 – 12,700	10	42240103	KSB 4530 A 50	-
			60	8,500 – 12,700	10	42240105	KSB 4530 A 60	-
			80	8,500 – 12,700	10	42240108	KSB 4530 A 80	-
			150	8,500 – 12,700	10	42240115	KSB 4530 A 150	-
51	25	A	40	7,500 – 11,200	10	42240504	KSB 5125 A 40	-
			60	7,500 – 11,200	10	42240505	KSB 5125 A 60	-
			80	7,500 – 11,200	10	42240508	KSB 5125 A 80	-
			150	7,500 – 11,200	10	42240515	KSB 5125 A 150	-
60	30	A	40	6,500 – 9,500	10	42241104	KSB 6030 A 40	-
			50	6,500 – 9,500	10	42241103	KSB 6030 A 50	-
			60	6,500 – 9,500	10	42241105	KSB 6030 A 60	-
			80	6,500 – 9,500	10	42241108	KSB 6030 A 80	-
			150	6,500 – 9,500	10	42241115	KSB 6030 A 150	-
75	30	A	40	5,000 – 7,600	10	42242104	KSB 7530 A 40	-
			60	5,000 – 7,600	10	42242105	KSB 7530 A 60	-
			80	5,000 – 7,600	10	42242108	KSB 7530 A 80	-
			150	5,000 – 7,600	10	42242115	KSB 7530 A 150	-



Bulk pack GSB

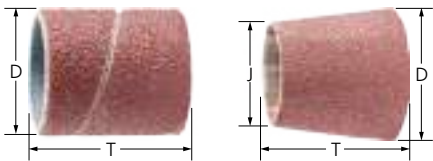

Aluminium oxide A version

For general applications from coarse to fine grinding. The packaging size is ideally suited to industrial requirements.



Special features:

- The abrasive spiral band is firmly held in place on the rubber drum holder as the holder expands during use. The rubber drum holder must be ordered separately.
- Outstanding tool life due to special manufacturing process – even under the most demanding operating conditions.
- Maximum economic efficiency thanks to particularly high stock removal rate and aggressive abrasive quality.

D [mm]	J [mm]	T [mm]	Abrasive	Grit size	Opt. RPM		Item no.	Designation	Price/unit EUR
Cylindrical shape									
4	-	10	A	150	30,000 – 55,000	100	42200415	GSB 0410 A 150	-
6	-	10	A	150	30,000 – 55,000	100	42200615	GSB 0610 A 150	-
8	-	10	A	150	30,000 – 55,000	100	42200815	GSB 0810 A 150	-
10	-	10	A	80	30,000 – 44,000	100	42201108	GSB 1010 A 80	-
				150	30,000 – 44,000	100	42201115	GSB 1010 A 150	-
				240	30,000 – 44,000	100	42202124	GSB 1020 A 240	-
		20	A	60	30,000 – 44,000	100	42202106	GSB 1020 A 60	-
				80	30,000 – 44,000	100	42202108	GSB 1020 A 80	-
				150	30,000 – 44,000	100	42202115	GSB 1020 A 150	-
13	-	10	A	80	30,000 – 44,000	100	42203108	GSB 1310 A 80	-
				150	30,000 – 44,000	100	42203115	GSB 1310 A 150	-
		25	A	80	30,000 – 44,000	100	42204108	GSB 1325 A 80	-
				150	30,000 – 44,000	100	42204115	GSB 1325 A 150	-
15	-	10	A	60	26,000 – 36,000	100	42205105	GSB 1510 A 60	-
				80	26,000 – 36,000	100	42205108	GSB 1510 A 80	-

Continued on next page

Abrasive spiral bands

Bulk pack GSB



D [mm]	J [mm]	T [mm]	Abrasive	Grit size	Opt. RPM		Item no.	Designation	Price/ unit EUR				
15	-	10	A	150	26,000 – 36,000	100	42205115	GSB 1510 A 150	-				
			A	50	26,000 – 36,000	100	42206103	GSB 1530 A 50	-				
		30	A	60	26,000 – 36,000	100	42206105	GSB 1530 A 60	-				
			A	80	26,000 – 36,000	100	42206108	GSB 1530 A 80	-				
			A	150	26,000 – 36,000	100	42206115	GSB 1530 A 150	-				
			A	240	26,000 – 36,000	100	42206124	GSB 1530 A 240	-				
19	-	25	A	60	20,000 – 30,000	100	42206505	GSB 1925 A 60	-				
			A	80	20,000 – 30,000	100	42206508	GSB 1925 A 80	-				
			A	150	20,000 – 30,000	100	42206515	GSB 1925 A 150	-				
22	-	20	A	50	18,000 – 26,000	100	42207104	GSB 2220 A 50	-				
			A	60	18,000 – 26,000	100	42207105	GSB 2220 A 60	-				
			A	80	18,000 – 26,000	100	42207108	GSB 2220 A 80	-				
			A	150	18,000 – 26,000	100	42207115	GSB 2220 A 150	-				
			A	240	18,000 – 26,000	100	42207124	GSB 2220 A 240	-				
25	-	25	A	60	16,000 – 22,900	100	42207505	GSB 2525 A 60	-				
			A	80	16,000 – 22,900	100	42207508	GSB 2525 A 80	-				
			A	150	16,000 – 22,900	100	42207515	GSB 2525 A 150	-				
30	-	20	A	40	13,000 – 19,100	100	42208104	GSB 3020 A 40	-				
			A	60	13,000 – 19,100	100	42208105	GSB 3020 A 60	-				
			A	80	13,000 – 19,100	100	42208108	GSB 3020 A 80	-				
			A	150	13,000 – 19,100	100	42208115	GSB 3020 A 150	-				
		30	A	40	13,000 – 19,100	100	42209104	GSB 3030 A 40	-				
				50	13,000 – 19,100	100	42209103	GSB 3030 A 50	-				
				60	13,000 – 19,100	100	42209105	GSB 3030 A 60	-				
				80	13,000 – 19,100	100	42209108	GSB 3030 A 80	-				
				150	13,000 – 19,100	100	42209115	GSB 3030 A 150	-				
				240	13,000 – 19,100	100	42209124	GSB 3030 A 240	-				
				38	-	25	A	40	10,000 – 15,900	100	42209504	GSB 3825 A 40	-
							A	60	10,000 – 15,900	100	42209505	GSB 3825 A 60	-
							A	80	10,000 – 15,900	100	42209508	GSB 3825 A 80	-
							A	150	10,000 – 15,900	100	42209515	GSB 3825 A 150	-
45	-	30	A	40	8,500 – 12,700	100	42210104	GSB 4530 A 40	-				
			A	50	8,500 – 12,700	100	42210103	GSB 4530 A 50	-				
			A	60	8,500 – 12,700	100	42210105	GSB 4530 A 60	-				
			A	80	8,500 – 12,700	100	42210108	GSB 4530 A 80	-				
			A	150	8,500 – 12,700	100	42210115	GSB 4530 A 150	-				
			A	240	8,500 – 12,700	100	42210124	GSB 4530 A 240	-				
51	-	25	A	40	7,500 – 11,200	100	42210504	GSB 5125 A 40	-				
			A	60	7,500 – 11,200	100	42210505	GSB 5125 A 60	-				
			A	80	7,500 – 11,200	100	42210508	GSB 5125 A 80	-				
			A	150	7,500 – 11,200	100	42210515	GSB 5125 A 150	-				
60	-	30	A	40	6,500 – 9,500	100	42211104	GSB 6030 A 40	-				
			A	50	6,500 – 9,500	100	42211103	GSB 6030 A 50	-				
			A	60	6,500 – 9,500	100	42211105	GSB 6030 A 60	-				
			A	80	6,500 – 9,500	100	42211108	GSB 6030 A 80	-				
			A	150	6,500 – 9,500	100	42211115	GSB 6030 A 150	-				
75	-	30	A	40	5,000 – 7,600	100	42212104	GSB 7530 A 40	-				
			A	60	5,000 – 7,600	100	42212105	GSB 7530 A 60	-				
			A	80	5,000 – 7,600	100	42212108	GSB 7530 A 80	-				
			A	150	5,000 – 7,600	100	42212115	GSB 7530 A 150	-				
100	-	40	A	40	4,000 – 5,700	50	42213104	GSB 10040 A 40	-				
			A	60	4,000 – 5,700	50	42213105	GSB 10040 A 60	-				
			A	80	4,000 – 5,700	50	42213108	GSB 10040 A 80	-				
			A	150	4,000 – 5,700	50	42213115	GSB 10040 A 150	-				

Continued on next page

D [mm]	J [mm]	T [mm]	Abrasive	Grit size	Opt. RPM		Item no.	Designation	Price/unit EUR
Conical shape									
20	14	63	A	40	19,000 – 26,000	100	42214104	GSB 201463 A 40	-
				60	19,000 – 26,000	100	42214105	GSB 201463 A 60	-
				80	19,000 – 26,000	100	42214108	GSB 201463 A 80	-
				150	19,000 – 26,000	100	42214115	GSB 201463 A 150	-
				240	19,000 – 26,000	100	42214124	GSB 201463 A 240	-
29	22	30	A	40	13,000 – 19,100	100	42215104	GSB 292230 A 40	-
				60	13,000 – 19,100	100	42215105	GSB 292230 A 60	-
				80	13,000 – 19,100	100	42215108	GSB 292230 A 80	-
				150	13,000 – 19,100	100	42215115	GSB 292230 A 150	-
36	22	60	A	40	10,000 – 15,900	100	42216104	GSB 362260 A 40	-
				60	10,000 – 15,900	100	42216105	GSB 362260 A 60	-
				80	10,000 – 15,900	100	42216108	GSB 362260 A 80	-
				150	10,000 – 15,900	100	42216115	GSB 362260 A 150	-

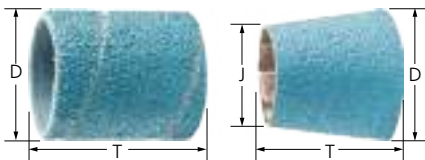

Zirconia alumina Z version

For coarse grinding work with a high stock removal rate and a long tool life. The packaging size is ideally suited to industrial requirements.



Special features:

- The abrasive spiral band is firmly held in place on the rubber drum holder as the holder expands during use. The rubber drum holder must be ordered separately.
- Outstanding tool life due to special manufacturing process – even under the most demanding operating conditions.
- Maximum economic efficiency thanks to particularly high stock removal rate and aggressive abrasive quality.

D [mm]	J [mm]	T [mm]	Abrasive	Grit size	Opt. RPM		Item no.	Designation	Price/unit EUR
Cylindrical shape									
13	-	25	Z	50	30,000 – 44,000	100	42217063	GSB 1325 Z 50	-
				60	30,000 – 44,000	100	42217064	GSB 1325 Z 60	-
				80	30,000 – 44,000	100	42217065	GSB 1325 Z 80	-
				120	30,000 – 44,000	100	42217066	GSB 1325 Z 120	-
19	-	25	Z	40	20,000 – 30,000	100	42217092	GSB 1925 Z 40	-
				50	20,000 – 30,000	100	42217093	GSB 1925 Z 50	-
				60	20,000 – 30,000	100	42217094	GSB 1925 Z 60	-
				80	20,000 – 30,000	100	42217095	GSB 1925 Z 80	-
				120	20,000 – 30,000	100	42217096	GSB 1925 Z 120	-
25	-	25	Z	36	16,000 – 22,900	100	42217111	GSB 2525 Z 36	-
				40	16,000 – 22,900	100	42217112	GSB 2525 Z 40	-
				50	16,000 – 22,900	100	42217113	GSB 2525 Z 50	-
				60	16,000 – 22,900	100	42217114	GSB 2525 Z 60	-
				80	16,000 – 22,900	100	42217115	GSB 2525 Z 80	-
				120	16,000 – 22,900	100	42217116	GSB 2525 Z 120	-
30	-	30	Z	36	13,000 – 19,100	100	42217131	GSB 3030 Z 36	-
				40	13,000 – 19,100	100	42217132	GSB 3030 Z 40	-
				50	13,000 – 19,100	100	42217133	GSB 3030 Z 50	-
				60	13,000 – 19,100	100	42217134	GSB 3030 Z 60	-
				80	13,000 – 19,100	100	42217135	GSB 3030 Z 80	-
38	-	25	Z	36	10,000 – 15,900	100	42217141	GSB 3825 Z 36	-

Continued on next page



Abrasive spiral bands

Bulk pack GSB



D [mm]	J [mm]	T [mm]	Abrasive	Grit size	Opt. RPM		Item no.	Designation	Price/unit EUR
38	-	25	Z	40	10,000 – 15,900	100	42217142	GSB 3825 Z 40	-
				50	10,000 – 15,900	100	42217143	GSB 3825 Z 50	-
				60	10,000 – 15,900	100	42217144	GSB 3825 Z 60	-
				80	10,000 – 15,900	100	42217145	GSB 3825 Z 80	-
				120	10,000 – 15,900	100	42217146	GSB 3825 Z 120	-
45	-	30	Z	40	8,500 – 12,700	100	42217152	GSB 4530 Z 40	-
				50	8,500 – 12,700	100	42217153	GSB 4530 Z 50	-
				60	8,500 – 12,700	100	42217154	GSB 4530 Z 60	-
				80	8,500 – 12,700	100	42217155	GSB 4530 Z 80	-
51	-	25	Z	36	7,500 – 11,200	100	42217161	GSB 5125 Z 36	-
				40	7,500 – 11,200	100	42217162	GSB 5125 Z 40	-
				50	7,500 – 11,200	100	42217163	GSB 5125 Z 50	-
				60	7,500 – 11,200	100	42217164	GSB 5125 Z 60	-
				80	7,500 – 11,200	100	42217165	GSB 5125 Z 80	-
				120	7,500 – 11,200	100	42217166	GSB 5125 Z 120	-
Conical shape									
20	14	63	Z	36	19,000 – 26,000	100	42217167	GSB 201463 Z 36	-
				50	19,000 – 26,000	100	42217168	GSB 201463 Z 50	-
				60	19,000 – 26,000	100	42217169	GSB 201463 Z 60	-
				80	19,000 – 26,000	100	42217170	GSB 201463 Z 80	-
				120	19,000 – 26,000	100	42217171	GSB 201463 Z 120	-
29	22	30	Z	36	13,000 – 19,100	100	42217172	GSB 292230 Z 36	-
				50	13,000 – 19,100	100	42217173	GSB 292230 Z 50	-
				60	13,000 – 19,100	100	42217174	GSB 292230 Z 60	-
				80	13,000 – 19,100	100	42217175	GSB 292230 Z 80	-
				120	13,000 – 19,100	100	42217176	GSB 292230 Z 120	-
36	22	60	Z	36	10,000 – 15,900	100	42217177	GSB 362260 Z 36	-
				50	10,000 – 15,900	100	42217178	GSB 362260 Z 50	-
				60	10,000 – 15,900	100	42217179	GSB 362260 Z 60	-
				80	10,000 – 15,900	100	42217180	GSB 362260 Z 80	-
				120	10,000 – 15,900	100	42217181	GSB 362260 Z 120	-

4



Zirconia alumina Z-COOL version

For coarse grinding work with a high stock removal rate and cool grinding. Active grinding additives in the coating substantially improve the stock removal rate, prevent clogging and result in cooler grinding. The packaging size is ideally suited to industrial requirements.



Special features:

- The abrasive spiral band is firmly held in place on the rubber drum holder as the holder expands during use. The rubber drum holder must be ordered separately.
- Outstanding tool life due to special manufacturing process – even under the most demanding operating conditions.
- Maximum economic efficiency thanks to particularly high stock removal rate and aggressive abrasive quality.

D [mm]	T [mm]	Abrasive	Grit size	Opt. RPM		Item no.	Designation	Price/unit EUR
Cylindrical shape								
15	30	Z-COOL	50	26,000 – 36,000	100	42206183	GSB 1530 Z-COOL 50	-
			80	26,000 – 36,000	100	42206188	GSB 1530 Z-COOL 80	-
			150	26,000 – 36,000	100	42206285	GSB 1530 Z-COOL 150	-
22	20	Z-COOL	50	18,000 – 26,000	100	42207184	GSB 2220 Z-COOL 50	-

Continued on next page

D [mm]	T [mm]	Abrasive	Grit size	Opt. RPM		Item no.	Designation	Price/unit EUR
22	20	Z-COOL	80	18,000 – 26,000	100	42207188	GSB 2220 Z-COOL 80	-
			150	18,000 – 26,000	100	42207285	GSB 2220 Z-COOL 150	-
30	30	Z-COOL	36	13,000 – 19,100	100	42209182	GSB 3030 Z-COOL 36	-
			50	13,000 – 19,100	100	42209183	GSB 3030 Z-COOL 50	-
			80	13,000 – 19,100	100	42209188	GSB 3030 Z-COOL 80	-
			150	13,000 – 19,100	100	42209285	GSB 3030 Z-COOL 150	-
			36	8,500 – 12,700	100	42210182	GSB 4530 Z-COOL 36	-
45	30	Z-COOL	50	8,500 – 12,700	100	42210183	GSB 4530 Z-COOL 50	-
			80	8,500 – 12,700	100	42210188	GSB 4530 Z-COOL 80	-
			150	8,500 – 12,700	100	42210285	GSB 4530 Z-COOL 150	-
60	30	Z-COOL	36	6,500 – 9,500	100	42211182	GSB 6030 Z-COOL 36	-
			50	6,500 – 9,500	100	42211183	GSB 6030 Z-COOL 50	-
			80	6,500 – 9,500	100	42211188	GSB 6030 Z-COOL 80	-
			150	6,500 – 9,500	100	42211285	GSB 6030 Z-COOL 150	-

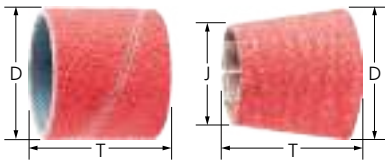

Ceramic oxide grain CO-COOL version

Consistently high performance and aggressive grinding due to self-sharpening ceramic oxide grain. Active grinding additives improve the stock removal rate, prevent clogging and result in cooler grinding. The packaging size is ideally suited to industrial requirements.



Special features:

- The abrasive spiral band is firmly held in place on the rubber drum holder as the holder expands during use. The rubber drum holder must be ordered separately.
- Outstanding tool life due to special manufacturing process – even under the most demanding operating conditions.
- Maximum economic efficiency thanks to particularly high stock removal rate and aggressive abrasive quality.

D [mm]	J [mm]	T [mm]	Abrasive	Grit size	Opt. RPM		Item no.	Designation	Price/unit EUR
Cylindrical shape									
13	-	25	CO-COOL	60	30,000 – 44,000	100	42204205	GSB 1325 CO-COOL 60	-
				80	30,000 – 44,000	100	42204208	GSB 1325 CO-COOL 80	-
				120	30,000 – 44,000	100	42204212	GSB 1325 CO-COOL 120	-
15	-	30	CO-COOL	60	26,000 – 36,000	100	42206305	GSB 1530 CO-COOL 60	-
				80	26,000 – 36,000	100	42206308	GSB 1530 CO-COOL 80	-
				120	26,000 – 36,000	100	42206312	GSB 1530 CO-COOL 120	-
19	-	25	CO-COOL	36	20,000 – 30,000	100	42206702	GSB 1925 CO-COOL 36	-
				60	20,000 – 30,000	100	42206705	GSB 1925 CO-COOL 60	-
				80	20,000 – 30,000	100	42206708	GSB 1925 CO-COOL 80	-
				120	20,000 – 30,000	100	42206712	GSB 1925 CO-COOL 120	-
22	-	20	CO-COOL	60	18,000 – 26,000	100	42207305	GSB 2220 CO-COOL 60	-
				80	18,000 – 26,000	100	42207308	GSB 2220 CO-COOL 80	-
				120	18,000 – 26,000	100	42207312	GSB 2220 CO-COOL 120	-
25	-	25	CO-COOL	36	16,000 – 22,900	100	42207702	GSB 2525 CO-COOL 36	-
				60	16,000 – 22,900	100	42207705	GSB 2525 CO-COOL 60	-
				80	16,000 – 22,900	100	42207708	GSB 2525 CO-COOL 80	-
				120	16,000 – 22,900	100	42207712	GSB 2525 CO-COOL 120	-
30	-	30	CO-COOL	36	13,000 – 19,100	100	42209302	GSB 3030 CO-COOL 36	-
				60	13,000 – 19,100	100	42209305	GSB 3030 CO-COOL 60	-
				80	13,000 – 19,100	100	42209308	GSB 3030 CO-COOL 80	-
				120	13,000 – 19,100	100	42209312	GSB 3030 CO-COOL 120	-

Continued on next page



Abrasive spiral bands

Bulk pack GSB



D [mm]	J [mm]	T [mm]	Abrasive	Grit size	Opt. RPM		Item no.	Designation	Price/unit EUR
38	-	25	CO-COOL	36	10,000 – 15,900	100	42209702	GSB 3825 CO-COOL 36	-
				60	10,000 – 15,900	100	42209705	GSB 3825 CO-COOL 60	-
				80	10,000 – 15,900	100	42209708	GSB 3825 CO-COOL 80	-
				120	10,000 – 15,900	100	42209712	GSB 3825 CO-COOL 120	-
45	-	30	CO-COOL	36	8,500 – 12,700	100	42210302	GSB 4530 CO-COOL 36	-
				60	8,500 – 12,700	100	42210305	GSB 4530 CO-COOL 60	-
				80	8,500 – 12,700	100	42210308	GSB 4530 CO-COOL 80	-
				120	8,500 – 12,700	100	42210312	GSB 4530 CO-COOL 120	-
51	-	25	CO-COOL	36	7,500 – 11,200	100	42210602	GSB 5125 CO-COOL 36	-
				60	7,500 – 11,200	100	42210605	GSB 5125 CO-COOL 60	-
				120	7,500 – 11,200	100	42210612	GSB 5125 CO-COOL 120	-
60	-	30	CO-COOL	36	6,500 – 9,500	100	42211302	GSB 6030 CO-COOL 36	-
				60	6,500 – 9,500	100	42211305	GSB 6030 CO-COOL 60	-
				80	6,500 – 9,500	100	42211308	GSB 6030 CO-COOL 80	-
				120	6,500 – 9,500	100	42211312	GSB 6030 CO-COOL 120	-
Conical shape									
20	14	63	CO-COOL	36	19,000 – 26,000	100	42217182	GSB 201463 CO-COOL 36	-
				60	19,000 – 26,000	100	42217183	GSB 201463 CO-COOL 60	-
				80	19,000 – 26,000	100	42217184	GSB 201463 CO-COOL 80	-
				120	19,000 – 26,000	100	42217185	GSB 201463 CO-COOL 120	-
29	22	30	CO-COOL	36	13,000 – 19,100	100	42217186	GSB 292230 CO-COOL 36	-
				60	13,000 – 19,100	100	42217187	GSB 292230 CO-COOL 60	-
				80	13,000 – 19,100	100	42217188	GSB 292230 CO-COOL 80	-
				120	13,000 – 19,100	100	42217189	GSB 292230 CO-COOL 120	-
36	22	60	CO-COOL	36	10,000 – 15,900	100	42217190	GSB 362260 CO-COOL 36	-
				60	10,000 – 15,900	100	42217191	GSB 362260 CO-COOL 60	-
				80	10,000 – 15,900	100	42217192	GSB 362260 CO-COOL 80	-
				120	10,000 – 15,900	100	42217193	GSB 362260 CO-COOL 120	-

4

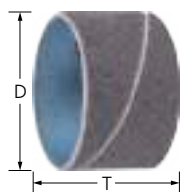

Silicon carbide SiC version

For general grinding work. Particularly recommended for use on titanium alloys. Ideally suited for use in the aircraft industry, particularly when SiC is the only abrasive approved for use. The packaging size is ideally suited to industrial requirements.



Special features:

- The abrasive spiral band is firmly held in place on the rubber drum holder as the holder expands during use. The rubber drum holder must be ordered separately.
- Outstanding tool life due to special manufacturing process – even under the most demanding operating conditions.
- Maximum economic efficiency thanks to particularly high stock removal rate and aggressive abrasive quality.

D [mm]	T [mm]	Abrasive	Grit size	Opt. RPM		Item no.	Designation	Price/unit EUR
Cylindrical shape								
10	20	SiC	60	30,000 – 44,000	100	42210060	GSB 1020 SiC 60	-
			80	30,000 – 44,000	100	42210080	GSB 1020 SiC 80	-
			100	30,000 – 44,000	100	42210100	GSB 1020 SiC 100	-
			150	30,000 – 44,000	100	42210150	GSB 1020 SiC 150	-
13	25	SiC	60	30,000 – 44,000	100	42213060	GSB 1325 SiC 60	-
			80	30,000 – 44,000	100	42213080	GSB 1325 SiC 80	-
			100	30,000 – 44,000	100	42213100	GSB 1325 SiC 100	-

Continued on next page

D [mm]	T [mm]	Abrasive	Grit size	Opt. RPM		Item no.	Designation	Price/unit EUR
13	25	SiC	150	30,000 – 44,000	100	42213150	GSB 1325 SiC 150	-
15	30	SiC	60	26,000 – 36,000	100	42215060	GSB 1530 SiC 60	-
			80	26,000 – 36,000	100	42215080	GSB 1530 SiC 80	-
			100	26,000 – 36,000	100	42215100	GSB 1530 SiC 100	-
			150	26,000 – 36,000	100	42215150	GSB 1530 SiC 150	-
			22	20	SiC	60	18,000 – 26,000	100
22	20	SiC	80	18,000 – 26,000	100	42222080	GSB 2220 SiC 80	-
			100	18,000 – 26,000	100	42222100	GSB 2220 SiC 100	-
			150	18,000 – 26,000	100	42222150	GSB 2220 SiC 150	-
			30	30	SiC	60	13,000 – 19,100	100
30	30	SiC	80	13,000 – 19,100	100	42230080	GSB 3030 SiC 80	-
			150	13,000 – 19,100	100	42230150	GSB 3030 SiC 150	-
			45	30	SiC	60	8,500 – 12,700	100
45	30	SiC	80	8,500 – 12,700	100	42245080	GSB 4530 SiC 80	-
			100	8,500 – 12,700	100	42245100	GSB 4530 SiC 100	-
			150	8,500 – 12,700	100	42245150	GSB 4530 SiC 150	-

Rubber drum holder GK





Conical and cylindrical types

Matching holder for conical and cylindrical abrasive spiral bands. Rubber drum holders marked "H" are the harder type and permit grinding at higher contact pressure. They are exceptionally well-suited to work on weld seams.

Special features:

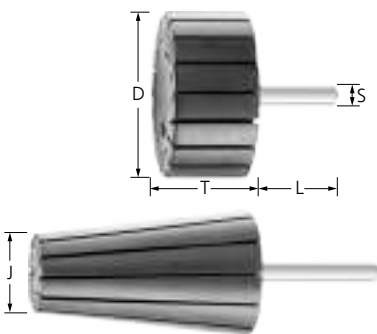
- The abrasive spiral band is firmly held in place on the rubber drum holder as the holder expands during use.
- Outstanding tool life due to special manufacturing process – even under the most demanding operating conditions.



D [mm]	J [mm]	T [mm]	S [mm]	L [mm]	Hardness [Shore A]	Acc. to ISO	Max. RPM	Min. RPM		Item no.	Designation	Price/unit EUR
Cylindrical shape												
4	-	10	3	40	65–70	-	55,000	30,000	5	42100413	GK 0410/3	-
			6	40	65–70	-	55,000	30,000	5	42100410	GK 0410/6	-
6	-	10	3	40	65–70	-	55,000	30,000	5	42100613	GK 0610/3	-
			6	40	65–70	-	55,000	30,000	5	42100610	GK 0610/6	-
8	-	10	3	40	65–70	-	55,000	30,000	5	42100813	GK 0810/3	-
			6	40	65–70	-	55,000	30,000	5	42100810	GK 0810/6	-
10	-	10	6	35	65–70	ISO 15637-1	44,000	30,000	5	42101000	GK 1010/6	-
		20	6	35	65–70	ISO 15637-1	44,000	30,000	5	42102000	GK 1020/6	-
13	-	10	6	35	65–70	-	44,000	30,000	5	42103000	GK 1310/6	-
		25	6	35	65–70	-	44,000	30,000	5	42104000	GK 1325/6	-
15	-	10	6	35	65–70	ISO 15637-1	36,000	26,000	5	42105000	GK 1510/6	-
		30	6	35	65–70	ISO 15637-1	36,000	26,000	5	42106000	GK 1530/6	-
19	-	25	6	35	65–70	-	30,000	20,000	5	42106500	GK 1925/6	-
22	-	20	6	35	65–70	ISO 15637-1	26,000	18,000	5	42107000	GK 2220/6	-
					80	ISO 15637-1	26,000	18,000	5	42107080	GK 2220/6 H	-
25	-	25	6	35	65–70	-	22,900	16,000	5	42107500	GK 2525/6	-
30	-	20	6	35	65–70	ISO 15637-1	19,100	13,000	5	42108000	GK 3020/6	-

Continued on next page

Abrasive spiral bands

Rubber drum holder GK



D [mm]	J [mm]	T [mm]	S [mm]	L [mm]	Hardness [Shore A]	Acc. to ISO	Max. RPM	Min. RPM		Item no.	Designation	Price/unit EUR
30	-	30	6	35	65-70	ISO 15637-1	19,100	13,000	5	42109000	GK 3030/6	-
					80	ISO 15637-1	19,100	13,000	5	42109080	GK 3030/6 H	-
38	-	25	6	35	65-70	-	15,900	10,000	5	42109500	GK 3825/6	-
45	-	30	6	35	65-70	ISO 15637-1	12,700	8,500	5	42110000	GK 4530/6	-
					80	ISO 15637-1	12,700	8,500	5	42110080	GK 4530/6 H	-
51	-	25	6	35	65-70	-	11,200	7,500	5	42110500	GK 5125/6	-
60	-	30	6	35	65-70	ISO 15637-1	9,500	6,500	5	42111006	GK 6030/6	-
			8	35	65-70	ISO 15637-1	9,500	6,500	5	42111008	GK 6030/8	-
75	-	30	8	35	65-70	ISO 15637-1	7,600	5,000	5	42112000	GK 7530/8	-
100	-	40	8	35	65-70	ISO 15637-1	5,700	4,000	5	42113000	GK 10040/8	-
Conical shape												
20	14	63	6	40	65-70	-	26,000	19,000	5	42119500	GK 201463/6	-
29	22	30	6	40	65-70	-	19,100	13,000	5	42121000	GK 292230/6	-
36	22	60	6	40	65-70	-	15,900	10,000	5	42122000	GK 362260/6	-

4



Safety notes

- The maximum permitted peripheral speed is 11 m/s.
- For safety reasons, the maximum permitted rotational speed indicated must never be exceeded.



Wear eye protection!



Wear hearing protection!



Wear gloves!



Wear a dust mask!



Follow the safety instructions!



Not permitted for wet grinding!



POLIROLL cartridge rolls PR and PRK, POLICO abrasive cones PCO

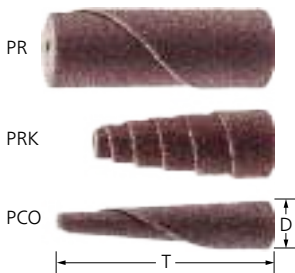

Aluminium oxide A version

Cartridge rolls and abrasive cones consisting of spirally wound, coated abrasives. For general grinding work in hard-to-reach areas on metals and other materials.



Special features:

- Consistently high grinding performance throughout its entire tool life thanks to ongoing exposure of fresh abrasive grain during application.
- POLIROLL/POLICO is securely fitted when in use due to self-tensioning provided by grooved, conical arbor, plus easy tool changes.
- Please order compatible arbor separately.

D [mm]	T [mm]	Abrasive	Grit size	Opt. RPM	Max. RPM	Suitable arbors		Item no.	Designation	Price/unit EUR	
Cylindrical shape (PR)											
6	25	A	80	20,000	25,000	BO 3-18-3, BO 6-18-3	50	42810608	PR 0625 A 80	-	
			150	20,000	25,000	BO 3-18-3, BO 6-18-3	50	42810615	PR 0625 A 150	-	
	35	A	80	20,000	25,000	BO 6-24-3	50	42810708	PR 0635 A 80	-	
			150	20,000	25,000	BO 6-24-3	50	42810715	PR 0635 A 150	-	
	9	25	A	80	15,000	23,000	BO 6-18-3	50	42810808	PR 0925 A 80	-
				150	15,000	23,000	BO 6-18-3	50	42810815	PR 0925 A 150	-
35		A	80	15,000	23,000	BO 6-24-3	50	42810908	PR 0935 A 80	-	
			150	15,000	23,000	BO 6-24-3	50	42810915	PR 0935 A 150	-	
12		25	A	50	12,000	17,000	BO 6-18-3	50	42811205	PR 1225 A 50	-
				80	12,000	17,000	BO 6-18-3	50	42811208	PR 1225 A 80	-
	150			12,000	17,000	BO 6-18-3	50	42811215	PR 1225 A 150	-	
	35	A	50	12,000	17,000	BO 6-24-3	50	42811305	PR 1235 A 50	-	
			80	12,000	17,000	BO 6-24-3	50	42811308	PR 1235 A 80	-	
			150	12,000	17,000	BO 6-24-3	50	42811315	PR 1235 A 150	-	
18	35	A	50	8,000	12,000	BO 6-25-5	50	42811805	PR 1835 A 50	-	
			80	8,000	12,000	BO 6-25-5	50	42811808	PR 1835 A 80	-	
			150	8,000	12,000	BO 6-25-5	50	42811815	PR 1835 A 150	-	
18	50	A	50	8,000	12,000	BO 6-30-5	50	42811905	PR 1850 A 50	-	
			80	8,000	12,000	BO 6-30-5	50	42811908	PR 1850 A 80	-	
			150	8,000	12,000	BO 6-30-5	50	42811915	PR 1850 A 150	-	

Continued on next page



POLIROLL, POLICO

POLIROLL cartridge rolls PR and PRK, POLICO abrasive cones PCO



D [mm]	T [mm]	Abrasive	Grit size	Opt. RPM	Max. RPM	Suitable arbors		Item no.	Designation	Price/unit EUR
Conical shape (PRK)										
10	25	A	80	15,000	23,000	BO 3-18-3, BO 6-18-3	50	42821008	PRK 1025 A 80	-
			150	15,000	23,000	BO 3-18-3, BO 6-18-3	50	42821015	PRK 1025 A 150	-
12	25	A	50	12,000	17,000	BO 6-18-3	50	42821205	PRK 1225 A 50	-
			80	12,000	17,000	BO 6-18-3	50	42821208	PRK 1225 A 80	-
			150	12,000	17,000	BO 6-18-3	50	42821215	PRK 1225 A 150	-
	35	A	50	12,000	17,000	BO 6-24-3	50	42821305	PRK 1235 A 50	-
			80	12,000	17,000	BO 6-24-3	50	42821308	PRK 1235 A 80	-
			150	12,000	17,000	BO 6-24-3	50	42821315	PRK 1235 A 150	-
15	35	A	50	10,000	15,000	BO 6-24-3	50	42821505	PRK 1535 A 50	-
			80	10,000	15,000	BO 6-24-3	50	42821508	PRK 1535 A 80	-
			150	10,000	15,000	BO 6-24-3	50	42821515	PRK 1535 A 150	-
POLICO abrasive cones (PCO)										
10	50	A	80	15,000	23,000	BO 6-50-8	50	42831008	PCO 1050 A 80	-
			150	15,000	23,000	BO 6-50-8	50	42831015	PCO 1050 A 150	-

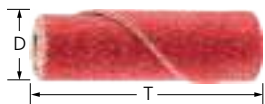

Ceramic oxide grain CO-COOL version

Cartridge rolls consisting of spirally wound, coated abrasives. Consistently high performance and aggressive grinding due to self-sharpening ceramic oxide grain. Active grinding additives improve the stock removal rate, prevent clogging and result in cooler grinding.



Special features:

- Consistently high grinding performance throughout its entire tool life thanks to ongoing exposure of fresh abrasive grain during application.
- POLIROLL/POLICO is securely fitted when in use due to self-tensioning provided by grooved, conical arbor, plus easy tool changes.
- Please order compatible arbor separately.

D [mm]	T [mm]	Abrasive	Grit size	Opt. RPM	Max. RPM	Suitable arbors		Item no.	Designation	Price/unit EUR
6	25	CO-COOL	60	20,000	25,000	BO 3-18-3, BO 6-18-3	50	42810646	PR 0625 CO-COOL 60	-
			80	20,000	25,000	BO 3-18-3, BO 6-18-3	50	42810648	PR 0625 CO-COOL 80	-
			120	20,000	25,000	BO 3-18-3, BO 6-18-3	50	42810650	PR 0625 CO-COOL 120	-
	35	CO-COOL	60	20,000	25,000	BO 6-24-3	50	42810746	PR 0635 CO-COOL 60	-
			80	20,000	25,000	BO 6-24-3	50	42810748	PR 0635 CO-COOL 80	-
			120	20,000	25,000	BO 6-24-3	50	42810750	PR 0635 CO-COOL 120	-
9	25	CO-COOL	60	15,000	23,000	BO 6-18-3	50	42810846	PR 0925 CO-COOL 60	-
			80	15,000	23,000	BO 6-18-3	50	42810848	PR 0925 CO-COOL 80	-
			120	15,000	23,000	BO 6-18-3	50	42810850	PR 0925 CO-COOL 120	-
	35	CO-COOL	60	15,000	23,000	BO 6-24-3	50	42810946	PR 0935 CO-COOL 60	-
			80	15,000	23,000	BO 6-24-3	50	42810948	PR 0935 CO-COOL 80	-
			120	15,000	23,000	BO 6-24-3	50	42810950	PR 0935 CO-COOL 120	-
12	25	CO-COOL	60	12,000	17,000	BO 6-18-3	50	42811246	PR 1225 CO-COOL 60	-
			80	12,000	17,000	BO 6-18-3	50	42811248	PR 1225 CO-COOL 80	-
			120	12,000	17,000	BO 6-18-3	50	42811250	PR 1225 CO-COOL 120	-
	35	CO-COOL	60	12,000	17,000	BO 6-24-3	50	42811346	PR 1235 CO-COOL 60	-
			80	12,000	17,000	BO 6-24-3	50	42811348	PR 1235 CO-COOL 80	-
			120	12,000	17,000	BO 6-24-3	50	42811350	PR 1235 CO-COOL 120	-

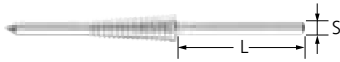

Arbor BO

Arbor for POLIROLL and POLICO tools.

Special features:

- Tool can be changed easily without unclamping the arbor from the tool drive collet.

- POLIROLL/POLICO is securely fitted when in use due to self-tensioning provided by grooved, conical arbor.

Suitable for	S [mm]	L [mm]		Item no.	Designation	Price/unit EUR
PR 0625, PRK 1025	3	27	1	42703183	BO 3-18-3	-
PR 0625, PR 0925, PR 1225, PRK 1025, PRK 1225	6	30	1	42706183	BO 6-18-3	-
PR 0625, PR 0925, PR 1235, PRK 1235, PRK 1535	6	30	1	42706243	BO 6-24-3	-
PR 1835	6	30	1	42706255	BO 6-25-5	-
PR 1850	6	30	1	42706305	BO 6-30-5	-
PCO 1050	6	30	1	42706508	BO 6-50-8	-



POLIROLL set

Coordinated set of various popular POLIROLL cartridge rolls with matching arbors.

Contents:

150 POLIROLL cartridge rolls with matching arbor, 20 x PR 0625, A 80 and A 150 respectively, 20 x PR 0925, A 80 and A 150 respectively, 20 x PR 1225, A 80 and A 150 respectively, 10 x PRK 1025, A 80 and A 150 respectively, 10 x PRK 1225, A 80.

Special features:

- Consistently high grinding performance throughout its entire tool life thanks to ongoing exposure of fresh abrasive grain during application.
- POLIROLL/POLICO is securely fitted when in use due to self-tensioning provided by grooved, conical arbor, plus easy tool changes.

L [mm]	B [mm]	H [mm]		Item no.	Designation	Price/unit EUR
180	145	40	1	49500151	PRS 151	-



The quick way to find the perfect tool

			Abrasive ▶		
Material group ▼			Aluminium oxide A	Ceramic oxide grain CO-COOL	Silicon carbide SiC-COOL
Steel, cast steel	Non-hardened, non-heat-treated steels	Construction steels, carbon steels, tool steels, non-alloyed steels, cast steel	●	○	
	Hardened, heat-treated steels	Tool steels, tempering steels, alloyed steels, cast steel	○	●	
Stainless steel (INOX)	Rust and acid-resistant steels	Austenitic and ferritic stainless steels		●	
Non-ferrous metals	Soft non-ferrous metals, non-ferrous metals	Soft aluminium alloys	○	○	●
		Brass, copper, zinc	●		
	Hard non-ferrous metals	Hard aluminium alloys	○		●
		Bronze, titanium		○	●
High-temperature-resistant materials	Nickel-based and cobalt-based alloys		●		
Cast iron	Grey cast iron, white cast iron	Cast iron with flake graphite EN-GJL (GG), with nodular graphite/nodular cast iron EN-GJS (GGG), white annealed cast iron EN-GJMW (GTW), black annealed cast iron EN-GJMB (GTS)	●	○	
Plastics, other materials		Fibre-reinforced plastics, thermoplastics, wood, chipboard, paint	○		●

● = highly suitable ○ = suitable

Colour code

POLICAP abrasive caps are available in different types and with different grains.

- Silicon carbide (SiC-COOL) grey
- Ceramic oxide grain (CO-COOL) red

- Colour code for the grit sizes for aluminium oxide A:
60/80 brown
150 black
280 red-brown

Safety notes

- The maximum permitted peripheral speed is 25 m/s.
- For safety reasons, the maximum permitted rotational speed indicated must never be exceeded.

 Wear eye protection!

 Wear hearing protection!

 Wear gloves!

 Wear a dust mask!

 Follow the safety instructions!





Abrasive caps PC ZYA

POLICAP abrasive caps in cylindrical shape ZYA with aluminium oxide A as the abrasive. They have a seamless design and the entire tool surface can be used.



Special features:

- The abrasive caps are firmly held in place on the holder as the holder expands during use, plus easy tool changes.
- Good dimensional stability and excellent fine grinding thanks to special manufacturing process.
- Optimally matched, reusable holders are available. The holder must be ordered separately.

D [mm]	T [mm]	Abrasive	Grit size	Opt. RPM		Item no.	Designation	Price/unit EUR
5	10	A	80	40,000	50	42301051	PC ZYA 0510 A 80	-
			150	40,000	50	42301052	PC ZYA 0510 A 150	-
			280	40,000	50	42301053	PC ZYA 0510 A 280	-
7	12	A	60	30,000	50	42301071	PC ZYA 0712 A 60	-
			150	30,000	50	42301072	PC ZYA 0712 A 150	-
			280	30,000	50	42301073	PC ZYA 0712 A 280	-
10	15	A	60	20,000	50	42301101	PC ZYA 1015 A 60	-
			150	20,000	50	42301102	PC ZYA 1015 A 150	-
			280	20,000	50	42301103	PC ZYA 1015 A 280	-
13	17	A	60	16,000	50	42301131	PC ZYA 1317 A 60	-
			150	16,000	50	42301132	PC ZYA 1317 A 150	-
			280	16,000	50	42301133	PC ZYA 1317 A 280	-
16	26	A	60	12,000	50	42301161	PC ZYA 1626 A 60	-
			150	12,000	50	42301162	PC ZYA 1626 A 150	-
			280	12,000	50	42301163	PC ZYA 1626 A 280	-

POLICAP abrasive cap holder (PCT), shape ZYA

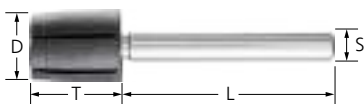

Abrasive cap holders PCT ZYA

Matching POLICAP abrasive cap holder in cylindrical shape ZYA.

Special features:

- The abrasive caps are firmly held in place on the holder as the holder expands during use.

- Easy tool change.

D [mm]	T [mm]	S [mm]	L [mm]	Max. RPM		Item no.	Designation	Price/unit EUR
5	10	3	25	95,000	5	42150000	PCT ZYA 0510 A/3	-
7	12	3	25	65,000	5	42150005	PCT ZYA 0712 A/3	-
10	15	3	25	45,000	5	42150010	PCT ZYA 1015 A/3	-
13	17	6	40	35,000	5	42151015	PCT ZYA 1317 A/6	-
16	26	6	40	30,000	5	42151020	PCT ZYA 1626 A/6	-

POLICAP

POLICAP set (PCS), shape ZYA



Set PCS ZYA

Set of various POLICAP abrasive caps with matching holder in cylindrical shape ZYA in sturdy, reusable packaging.



1626 A (grit size 60, 150, 280), ten each of the following POLICAP abrasive caps: PC ZYA 0510 A and 0712 A (grit size 60 or 80 and 150, 280) and one each of the following POLICAP abrasive cap holders: PCT ZYA 0510/3, 0712/3, 1015/3, 1317/6 and 1626/6.

Special features:

- The abrasive caps are firmly held in place on the holder as the holder expands during use.
- Good dimensional stability and excellent fine grinding thanks to special manufacturing process.
- Easy tool change.

Contents:

Five each of the following POLICAP abrasive caps: PC ZYA 1015 A, 1317 A and

Shape	L [mm]	B [mm]	H [mm]		Item no.	Designation	Price/unit EUR
ZYA	180	145	40	1	49601101	PCS ZYA 110	-

POLICAP (PC), shape WRC



Abrasive caps PC WRC

POLICAP abrasive caps in cylindrical shape with radius end WRC. Available in aluminium oxide A, silicon carbide SiC COOL and ceramic oxide grain CO-COOL. They have a seamless design and the entire tool surface can be used.



Special features:

- The abrasive caps are firmly held in place on the holder as the holder expands during use, plus easy tool changes.
- Good dimensional stability and excellent fine grinding thanks to special manufacturing process.
- Optimally matched, reusable holders are available. The holder must be ordered separately.

D [mm]	T [mm]	Abrasive	Grit size	Opt. RPM		Item no.	Designation	Price/unit EUR
Aluminium oxide A								
5	11	A	80	40,000	50	42302051	PC WRC 0511 A 80	-
			150	40,000	50	42302052	PC WRC 0511 A 150	-
			280	40,000	50	42302053	PC WRC 0511 A 280	-
7	13	A	60	30,000	50	42302071	PC WRC 0713 A 60	-
			150	30,000	50	42302072	PC WRC 0713 A 150	-
			280	30,000	50	42302073	PC WRC 0713 A 280	-
10	15	A	60	20,000	50	42302101	PC WRC 1015 A 60	-
			150	20,000	50	42302102	PC WRC 1015 A 150	-
			280	20,000	50	42302103	PC WRC 1015 A 280	-
13	17	A	60	16,000	50	42302131	PC WRC 1317 A 60	-
			150	16,000	50	42302132	PC WRC 1317 A 150	-
			280	16,000	50	42302133	PC WRC 1317 A 280	-
16	26	A	60	12,000	50	42302161	PC WRC 1626 A 60	-

Continued on next page

D [mm]	T [mm]	Abrasive	Grit size	Opt. RPM		Item no.	Designation	Price/unit EUR
16	26	A	150	12,000	50	42302162	PC WRC 1626 A 150	-
			280	12,000	50	42302163	PC WRC 1626 A 280	-
Silicon carbide SiC-COOL								
5	11	SiC-COOL	80	40,000	50	42302054	PC WRC 0511 SiC-COOL 80	-
			150	40,000	50	42302055	PC WRC 0511 SiC-COOL 150	-
7	13	SiC-COOL	80	30,000	50	42302074	PC WRC 0713 SiC-COOL 80	-
			150	30,000	50	42302075	PC WRC 0713 SiC-COOL 150	-
10	15	SiC-COOL	80	20,000	50	42302104	PC WRC 1015 SiC-COOL 80	-
			150	20,000	50	42302105	PC WRC 1015 SiC-COOL 150	-
13	17	SiC-COOL	80	16,000	50	42302134	PC WRC 1317 SiC-COOL 80	-
			150	16,000	50	42302135	PC WRC 1317 SiC-COOL 150	-
16	26	SiC-COOL	80	12,000	50	42302164	PC WRC 1626 SiC-COOL 80	-
			150	12,000	50	42302165	PC WRC 1626 SiC-COOL 150	-
CO-COOL								
5	11	CO-COOL	80	40,000	50	42302056	PC WRC 0511 CO-COOL 80	-
			120	40,000	50	42302057	PC WRC 0511 CO-COOL 120	-
7	13	CO-COOL	80	30,000	50	42302076	PC WRC 0713 CO-COOL 80	-
			120	30,000	50	42302077	PC WRC 0713 CO-COOL 120	-
10	15	CO-COOL	80	20,000	50	42302106	PC WRC 1015 CO-COOL 80	-
			120	20,000	50	42302107	PC WRC 1015 CO-COOL 120	-
13	17	CO-COOL	80	16,000	50	42302136	PC WRC 1317 CO-COOL 80	-
			120	16,000	50	42302137	PC WRC 1317 CO-COOL 120	-
16	26	CO-COOL	80	12,000	50	42302166	PC WRC 1626 CO-COOL 80	-
			120	12,000	50	42302167	PC WRC 1626 CO-COOL 120	-



POLICAP abrasive cap holder (PCT), shape WRC

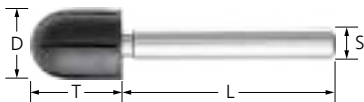

Abrasive cap holder PCT WRC

Matching POLICAP abrasive cap holder in cylindrical shape with radius end WRC.

Special features:

- The abrasive caps are firmly held in place on the holder as the holder expands during use.

- Easy tool change.

D [mm]	T [mm]	S [mm]	L [mm]	Max. RPM		Item no.	Designation	Price/unit EUR
5	11	2.35	40	30,000	5	47601046	PCT WRC 0511/2,35	-
		3	25	95,000	5	42150100	PCT WRC 0511/3	-
7	13	2.35	40	24,500	5	47601047	PCT WRC 0713/2,35	-
		3	25	65,000	5	42150105	PCT WRC 0713/3	-
10	15	2.35	40	17,500	5	47601048	PCT WRC 1015/2,35	-
		3	25	45,000	5	42150110	PCT WRC 1015/3	-
13	17	2.35	40	13,750	5	47601049	PCT WRC 1317/2,35	-
		6	40	35,000	5	42151115	PCT WRC 1317/6	-
16	26	6	40	30,000	5	42151120	PCT WRC 1626/6	-

POLICAP

POLICAP set (PCS), shape WRC



Set PCS WRC

Set of various POLICAP abrasive caps with matching holder in cylindrical shape with radius end WRC in sturdy, reusable packaging.



1626 A (grit size 60, 150, 280), ten each of the following POLICAP abrasive caps: PC WRC 0511 A and 0713 A (grit size 60 or 80 and 150, 280) and one each of the following POLICAP abrasive cap holders: PCT WRC 0511/3, 0713/3, 1015/3, 1317/6 and 1626/6.

Special features:

- The abrasive caps are firmly held in place on the holder as the holder expands during use.
- Good dimensional stability and excellent fine grinding thanks to special manufacturing process.
- Easy tool change.

Contents:

Five each of the following POLICAP abrasive caps: PC WRC 1015 A, 1317 A and

Shape	L [mm]	B [mm]	H [mm]		Item no.	Designation	Price/unit EUR
WRC	180	145	40	1	49601103	PCS WRC 110	-

POLICAP (PC), shape WKG



Abrasive caps PC WKG

POLICAP abrasive caps in tapered conical shape with radius end WKG with aluminium oxide A as the abrasive. The taper angle of the cone is 30°. They have a seamless design and the entire tool surface can be used. Optimally matched, reusable holders are available.

Special features:

- The abrasive caps are firmly held in place on the holder as the holder expands during use, plus easy tool changes.
- Good dimensional stability and excellent fine grinding thanks to special manufacturing process.
- Optimally matched, reusable holders are available. The holder must be ordered separately.

D [mm]	T [mm]	Abrasive	Grit size	Opt. RPM		Item no.	Designation	Price/unit EUR
5	11	A	80	40,000	50	42303051	PC WKG 0511 A 80	-
			150	40,000	50	42303052	PC WKG 0511 A 150	-
			280	40,000	50	42303053	PC WKG 0511 A 280	-
7	13	A	60	30,000	50	42303071	PC WKG 0713 A 60	-
			150	30,000	50	42303072	PC WKG 0713 A 150	-
			280	30,000	50	42303073	PC WKG 0713 A 280	-
10	15	A	60	20,000	50	42303101	PC WKG 1015 A 60	-
			150	20,000	50	42303102	PC WKG 1015 A 150	-
			280	20,000	50	42303103	PC WKG 1015 A 280	-
13	17	A	60	16,000	50	42303131	PC WKG 1317 A 60	-
			150	16,000	50	42303132	PC WKG 1317 A 150	-
			280	16,000	50	42303133	PC WKG 1317 A 280	-
16	26	A	60	12,000	50	42303161	PC WKG 1626 A 60	-
			150	12,000	50	42303162	PC WKG 1626 A 150	-
			280	12,000	50	42303163	PC WKG 1626 A 280	-

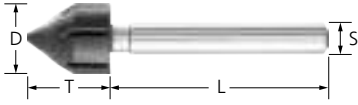

Abrasive cap holders PCT WKG

Matching POLICAP abrasive cap holder in tapered conical shape with radius end WKG.

Special features:

- The abrasive caps are firmly held in place on the holder as the holder expands during use.

- Easy tool change.

D [mm]	T [mm]	S [mm]	L [mm]	Max. RPM		Item no.	Designation	Price/unit EUR
5	11	3	25	95,000	5	42150200	PCT WKG 0511 G/3	-
7	13	3	25	65,000	5	42150205	PCT WKG 0713 G/3	-
10	15	3	25	45,000	5	42150210	PCT WKG 1015 G/3	-
13	17	2.35	40	13,750	5	47601022	PCT WKG 1317 G/2,35	-
		6	40	35,000	5	42151215	PCT WKG 1317 G/6	-
16	26	6	40	30,000	5	42151220	PCT WKG 1626 G/6	-

POLICAP set (PCS), shape WKG



Set PCS WKG

Set of various POLICAP abrasive caps with matching holder in tapered conical shape with radius end WKG in sturdy, reusable packaging.

Contents:

Five each of the following POLICAP abrasive caps: PC WKG 1015 A, 1317 A and 1626 A (grit size 60, 150, 280), ten each of the following POLICAP abrasive caps: PC WKG 0511 A and 0713 A (grit size 60 or 80 and 150, 280) and one each of the following POLICAP abrasive cap holders: PCT WKG 0511/3, 0713/3, 1015/3, 1317/6 and 1626/6.

Special features:

- The abrasive caps are firmly held in place on the holder as the holder expands during use.
- Good dimensional stability and excellent fine grinding thanks to special manufacturing process.
- Easy tool change.

Shape	L [mm]	B [mm]	H [mm]		Item no.	Designation	Price/unit EUR
WKG	180	145	40	1	49601107	PCS WKG 110	-



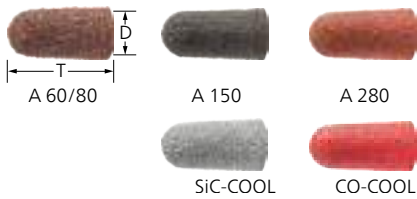

Abrasive caps PC KEL

POLICAP abrasive caps in conical shape with radius end KEL. Available in aluminium oxide A, silicon carbide SiC-COOL and ceramic oxide grain CO-COOL. They have a seamless design and the entire tool surface can be used. Optimally matched, reusable holders are available.



Special features:

- The abrasive caps are firmly held in place on the holder as the holder expands during use, plus easy tool changes.
- Good dimensional stability and excellent fine grinding thanks to special manufacturing process.
- Optimally matched, reusable holders are available. The holder must be ordered separately.

D [mm]	T [mm]	Abrasive	Grit size	Opt. RPM		Item no.	Designation	Price/unit EUR
Aluminium oxide A								
5	15	A	80	40,000	50	42306051	PC KEL 0515 A 80	-
			150	40,000	50	42306052	PC KEL 0515 A 150	-
			280	40,000	50	42306053	PC KEL 0515 A 280	-
11	25	A	60	20,000	50	42306111	PC KEL 1125 A 60	-
			150	20,000	50	42306112	PC KEL 1125 A 150	-
			280	20,000	50	42306113	PC KEL 1125 A 280	-
16	32	A	60	12,000	50	42306161	PC KEL 1632 A 60	-
			150	12,000	50	42306162	PC KEL 1632 A 150	-
			280	12,000	50	42306163	PC KEL 1632 A 280	-
21	40	A	60	9,500	50	42306211	PC KEL 2140 A 60	-
			150	9,500	50	42306212	PC KEL 2140 A 150	-
			280	9,500	50	42306213	PC KEL 2140 A 280	-
Silicon carbide SiC-COOL								
5	15	SiC-COOL	80	40,000	50	42306054	PC KEL 0515 SiC-COOL 80	-
			150	40,000	50	42306055	PC KEL 0515 SiC-COOL 150	-
11	25	SiC-COOL	80	20,000	50	42306114	PC KEL 1125 SiC-COOL 80	-
			150	20,000	50	42306115	PC KEL 1125 SiC-COOL 150	-
16	32	SiC-COOL	80	12,000	50	42306164	PC KEL 1632 SiC-COOL 80	-
			150	12,000	50	42306165	PC KEL 1632 SiC-COOL 150	-
21	40	SiC-COOL	80	9,500	50	42306214	PC KEL 2140 SiC-COOL 80	-
			150	9,500	50	42306215	PC KEL 2140 SiC-COOL 150	-
CO-COOL								
5	15	CO-COOL	80	40,000	50	42306056	PC KEL 0515 CO-COOL 80	-
			120	40,000	50	42306057	PC KEL 0515 CO-COOL 120	-
11	25	CO-COOL	80	20,000	50	42306116	PC KEL 1125 CO-COOL 80	-
			120	20,000	50	42306117	PC KEL 1125 CO-COOL 120	-
16	32	CO-COOL	80	12,000	50	42306166	PC KEL 1632 CO-COOL 80	-
			120	12,000	50	42306167	PC KEL 1632 CO-COOL 120	-
21	40	CO-COOL	80	9,500	50	42306216	PC KEL 2140 CO-COOL 80	-
			120	9,500	50	42306217	PC KEL 2140 CO-COOL 120	-



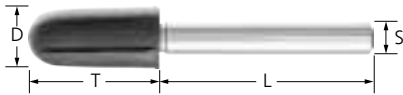

Abrasive cap holder PCT KEL

Matching POLICAP cup holder in conical shape with radius end KEL.

Special features:

- The abrasive caps and abrasive spiral bands are firmly held in place on the holder as the rubber surface offers optimal adhesion.

- Easy tool change.

D [mm]	T [mm]	S [mm]	L [mm]	Max. RPM		Item no.	Designation	Price/unit EUR
5	15	6	40	95,000	5	42151400	PCT KEL 0515/6	-
11	25	6	40	40,000	5	42151410	PCT KEL 1125/6	-
16	32	6	40	30,000	5	42151420	PCT KEL 1632/6	-
21	40	6	40	20,000	5	42151430	PCT KEL 2140/6	-

POLICAP set (PCS)



SET PCS 650

Set of various POLICAP abrasive caps with matching holder in sturdy, reusable packaging.



Contents:

Ten each of the following POLICAP abrasive caps: PC ZYA 1626 A and PC WKG 1626 A (grit size 150 and 280), 25 each of the following POLICAP abrasive caps: PC ZYA 1015 A, PC ZYA 1317 A, PC WKG 1015 A and PC WKG 1317 A (grit

size 150 and 280), 50 each of the following POLICAP abrasive caps: PC ZYA 0510 A, PC ZYA 0712 A, PC WKG 0511 A and PC WKG 0713 A (grit size 150 and 280), one each of the following POLICAP abrasive cap holders: PCT ZYA 0510/3, PCT ZYA 0712/3, PCT ZYA 1015/3, PCT ZYA 1317/6, PCT ZYA 1626/6, PCT WKG 0511/3, PCT WKG 0713/3, PCT WKG 1015/3, PCT WKG 1317/6 and PCT WKG 1626/6.

Special features:

- The abrasive caps are firmly held in place on the holder as the holder expands during use.
- Good dimensional stability and excellent fine grinding thanks to special manufacturing process.
- Easy tool change.

Shape	L [mm]	B [mm]	H [mm]		Item no.	Designation	Price/unit EUR
ZYA, WKG	332	235	50	1	49606500	SET PCS 650	-





Abrasive spiral bands PCH

POLICAP abrasive spiral bands in conical shape with aluminium oxide A. They have a seamless design and the entire tool surface can be used. Optimally matched, reusable holders are available.

Special features:

- The abrasive caps are firmly held in place on the holder as the holder expands during use.
- Good dimensional stability and excellent fine grinding thanks to special manufacturing process.
- Optimally matched, reusable holders are available. The holder must be ordered separately.

D [mm]	J [mm]	T [mm]	Abrasive	Grit size	Opt. RPM		Item no.	Designation	Price/unit EUR
7	5	85	A	60	12,000	10	42330052	PCH 070585 LA 60	-
				150	12,000	10	42330054	PCH 070585 LA 150	-
				280	12,000	10	42330056	PCH 070585 LA 280	-
14	11	85	A	60	12,000	10	42330112	PCH 141185 LA 60	-
				150	12,000	10	42330114	PCH 141185 LA 150	-
20	15	65	A	60	18,500	10	42333012	PCH 201565 LA 60	-
				150	18,500	10	42333014	PCH 201565 LA 150	-
	16	85	A	60	12,000	10	42330162	PCH 201685 LA 60	-
				150	12,000	10	42330164	PCH 201685 LA 150	-
24	21	85	A	60	12,000	10	42330212	PCH 242185 LA 60	-
				150	12,000	10	42330214	PCH 242185 LA 150	-
36	22	65	A	60	13,000	10	42333212	PCH 362265 LA 60	-

POLICAP rubber drum holder (PCT), shape KEL



POLICAP rubber drum holder PCT

Rubber drum holder for POLICAP in conical shape with radius end KEL.

Special features:

- The abrasive spiral bands are firmly held in place on the holder as the holder expands during use.

D [mm]	T [mm]	S [mm]	L [mm]	Max. RPM		Item no.	Designation	Price/unit EUR
8	85	6	40	20,000	5	42152100	PCT KEL 0585/6	-
13	85	6	40	15,000	5	42152110	PCT KEL 1185/6	-
18	85	6	40	13,000	5	42152120	PCT KEL 1685/6	-
23	85	6	30	12,000	5	42152130	PCT KEL 2185/6	-

Rubber drum holder GK, conical shape

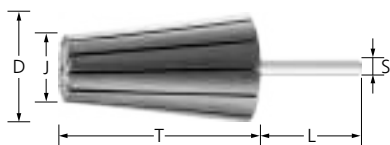

Rubber drum holder GK

Rubber drum holder for POLICAP in conical shape.

Special features:

- Easy tool change.
- The abrasive spiral bands are firmly held in place on the holder as the holder expands during use.

D [mm]	J [mm]	T [mm]	S [mm]	L [mm]	Hardness [Shore A]	Max. RPM	Minimum rotational speed [RPM]		Item no.	Designation	Price/unit EUR
20	14	63	6	40	65-70	26,000	19,000	5	42119500	GK 201463/6	-
36	22	60	6	40	65-70	15,900	10,000	5	42122000	GK 362260/6	-

The quick way to find the perfect tool

			Abrasive ▶			
Material group ▼			Aluminium oxide A	Zirconia alumina Z-COOL	Ceramic oxide grain CO-COOL	Silicon carbide SiC-COOL
Steel, cast steel	Non-hardened, non-heat-treated steels	Construction steels, carbon steels, tool steels, non-alloyed steels, cast steel	●	○	○	
	Hardened, heat-treated steels	Tool steels, tempering steels, alloyed steels, cast steel	○	●	●	
Stainless steel (INOX)	Rust and acid-resistant steels	Austenitic and ferritic stainless steels		●	●	
Non-ferrous metals	Soft non-ferrous metals, non-ferrous metals	Soft aluminium alloys	○			●
		Brass, copper, zinc	●	○	○	
	Hard non-ferrous metals	Hard aluminium alloys	○			●
		Bronze, titanium		○	○	●
	High-temperature- resistant materials	Nickel-based and cobalt-based alloys		○	●	
Cast iron	Grey cast iron, white cast iron	Cast iron with flake graphite EN-GJL (GG), with nodular graphite/nodular cast iron EN-GJS (GGG), white annealed cast iron EN-GJMW (GTW), black annealed cast iron EN-GJMB (GTS)	●	○	●	
Plastics, other materials		Fibre-reinforced plastics, thermoplastics, wood, chipboard, paint	○			●

● = highly suitable ○ = suitable

Safety notes

- For safety reasons, the maximum permitted rotational speed indicated must never be exceeded.
- The contact pressure must be significantly reduced if the specified optimum rotational speed is exceeded.
- Safety can only be guaranteed if the clamping length is at least 15 mm and the specified maximum rotational speed is not exceeded with unsupported shank lengths.



Wear eye protection!



Wear hearing protection!



Wear gloves!



Wear a dust mask!



Follow the safety instructions!



Flap tools

Mounted flap wheels F

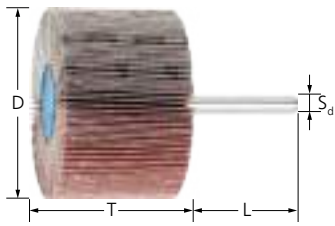

Aluminium oxide A version

The flaps made of coated abrasive are arranged radially around the axis in a fan-type structure. For general applications from coarse to fine grinding.



Special features:

- Highly flexible, enabling optimal adjustment to the contour.
- Consistently high stock removal rate over the entire tool life as new, aggressive abrasive is constantly exposed.
- Can be used face-down very close to edges and in corners thanks to the flat, moulded-core design.

D [mm]	T [mm]	Abrasive	Grit size	Opt. RPM	Max. RPM		Item no.	Designation	Price/unit EUR
Shank diameter of 3 x 40 mm [S_d x L]									
10	10	A	60	38,000	75,000	10	44400002	F 1010/3 A 60	-
			80	38,000	75,000	10	44400003	F 1010/3 A 80	-
			120	38,000	75,000	10	44400004	F 1010/3 A 120	-
			150	38,000	75,000	10	44400005	F 1010/3 A 150	-
			180	38,000	75,000	10	44400006	F 1010/3 A 180	-
			320	38,000	75,000	10	44400008	F 1010/3 A 320	-
	15	A	60	38,000	75,000	10	44400012	F 1015/3 A 60	-
			80	38,000	75,000	10	44400013	F 1015/3 A 80	-
			120	38,000	75,000	10	44400014	F 1015/3 A 120	-
			150	38,000	75,000	10	44400015	F 1015/3 A 150	-
			180	38,000	75,000	10	44400016	F 1015/3 A 180	-
			320	38,000	75,000	10	44400018	F 1015/3 A 320	-
15	5	A	60	25,000	50,000	10	44400022	F 1505/3 A 60	-
			80	25,000	50,000	10	44400023	F 1505/3 A 80	-
			120	25,000	50,000	10	44400024	F 1505/3 A 120	-
			150	25,000	50,000	10	44400025	F 1505/3 A 150	-
			180	25,000	50,000	10	44400026	F 1505/3 A 180	-
			320	25,000	50,000	10	44400028	F 1505/3 A 320	-
	10	A	60	25,000	50,000	10	44400032	F 1510/3 A 60	-
			80	25,000	50,000	10	44400033	F 1510/3 A 80	-
			120	25,000	50,000	10	44400034	F 1510/3 A 120	-
			150	25,000	50,000	10	44400035	F 1510/3 A 150	-
			180	25,000	50,000	10	44400036	F 1510/3 A 180	-
			320	25,000	50,000	10	44400038	F 1510/3 A 320	-
	15	A	60	25,000	50,000	10	44400042	F 1515/3 A 60	-
			80	25,000	50,000	10	44400043	F 1515/3 A 80	-
			120	25,000	50,000	10	44400044	F 1515/3 A 120	-
			150	25,000	50,000	10	44400045	F 1515/3 A 150	-
			180	25,000	50,000	10	44400046	F 1515/3 A 180	-
			320	25,000	50,000	10	44400048	F 1515/3 A 320	-
20	10	A	80	19,000	38,100	10	47801206	F 2010/3 A 80	-
			120	19,000	38,100	10	44400123	F 2010/3 A 120	-
			150	19,000	38,100	10	44400153	F 2010/3 A 150	-
			180	19,000	38,100	10	44400183	F 2010/3 A 180	-
			240	19,000	38,100	10	47801527	F 2010/3 A 240	-
			320	19,000	38,100	10	47801528	F 2010/3 A 320	-
30	5	A	60	12,000	25,400	10	44401063	F 3005/3 A 60	-
			80	12,000	25,400	10	44401083	F 3005/3 A 80	-
			120	12,000	25,400	10	44401123	F 3005/3 A 120	-
			150	12,000	25,400	10	44401153	F 3005/3 A 150	-

Continued on next page





D [mm]	T [mm]	Abrasive	Grit size	Opt. RPM	Max. RPM		Item no.	Designation	Price/unit EUR
30	5	A	180	12,000	25,400	10	44401183	F 3005/3 A 180	-
			240	12,000	25,400	10	44401243	F 3005/3 A 240	-
			320	12,000	25,400	10	44401323	F 3005/3 A 320	-
	10	A	60	12,000	25,400	10	44402063	F 3010/3 A 60	-
			80	12,000	25,400	10	44402083	F 3010/3 A 80	-
			120	12,000	25,400	10	44402123	F 3010/3 A 120	-
			150	12,000	25,400	10	44402153	F 3010/3 A 150	-
			180	12,000	25,400	10	44402183	F 3010/3 A 180	-
			240	12,000	25,400	10	44402243	F 3010/3 A 240	-
			320	12,000	25,400	10	44402323	F 3010/3 A 320	-
Shank diameter of 6 x 40 mm [S_d x L]									
20	10	A	60	19,000	38,100	10	47801067	F 2010/6 A 60	-
			80	19,000	38,100	10	44400086	F 2010/6 A 80	-
			120	19,000	38,100	10	44400126	F 2010/6 A 120	-
			150	19,000	38,100	10	44400156	F 2010/6 A 150	-
			180	19,000	38,100	10	44400186	F 2010/6 A 180	-
25	10	A	80	15,000	30,500	10	44405086	F 2510/6 A 80	-
			120	15,000	30,500	10	44405126	F 2510/6 A 120	-
			180	15,000	30,500	10	44405186	F 2510/6 A 180	-
	15	A	80	15,000	30,500	10	44406086	F 2515/6 A 80	-
			120	15,000	30,500	10	44406126	F 2515/6 A 120	-
			150	15,000	30,500	10	44406156	F 2515/6 A 150	-
	20	A	80	15,000	30,500	10	44415086	F 2520/6 A 80	-
			120	15,000	30,500	10	44415126	F 2520/6 A 120	-
			180	15,000	30,500	10	44415186	F 2520/6 A 180	-
	25	A	60	15,000	30,500	10	47801818	F 2525/6 A 60	-
			80	15,000	30,500	10	44410086	F 2525/6 A 80	-
			120	15,000	30,500	10	44410126	F 2525/6 A 120	-
			150	15,000	30,500	10	44410156	F 2525/6 A 150	-
			180	15,000	30,500	10	44410186	F 2525/6 A 180	-
	30	3	A	80	12,000	25,400	10	44416086	F 3003/6 A 80
120				12,000	25,400	10	44416126	F 3003/6 A 120	-
150				12,000	25,400	10	44416156	F 3003/6 A 150	-
180				12,000	25,400	10	44416186	F 3003/6 A 180	-
240				12,000	25,400	10	44416246	F 3003/6 A 240	-
320				12,000	25,400	10	44416326	F 3003/6 A 320	-
5		A	60	12,000	25,400	10	44401066	F 3005/6 A 60	-
			80	12,000	25,400	10	44401086	F 3005/6 A 80	-
			120	12,000	25,400	10	44401126	F 3005/6 A 120	-
			150	12,000	25,400	10	44401156	F 3005/6 A 150	-
			180	12,000	25,400	10	44401186	F 3005/6 A 180	-
			240	12,000	25,400	10	44401246	F 3005/6 A 240	-
			320	12,000	25,400	10	44401326	F 3005/6 A 320	-
10		A	60	12,000	25,400	10	44402066	F 3010/6 A 60	-
			80	12,000	25,400	10	44402086	F 3010/6 A 80	-
			120	12,000	25,400	10	44402126	F 3010/6 A 120	-
			150	12,000	25,400	10	44402156	F 3010/6 A 150	-
			180	12,000	25,400	10	44402186	F 3010/6 A 180	-
			240	12,000	25,400	10	44402246	F 3010/6 A 240	-
			320	12,000	25,400	10	44402326	F 3010/6 A 320	-
			400	12,000	25,400	10	44402406	F 3010/6 A 400	-
15		A	60	12,000	25,400	10	44409066	F 3015/6 A 60	-
			80	12,000	25,400	10	44409086	F 3015/6 A 80	-

Continued on next page



Flap tools

Mounted flap wheels F



D [mm]	T [mm]	Abrasive	Grit size	Opt. RPM	Max. RPM		Item no.	Designation	Price/unit EUR	
30	15	A	120	12,000	25,400	10	44409126	F 3015/6 A 120	-	
			150	12,000	25,400	10	44409156	F 3015/6 A 150	-	
			180	12,000	25,400	10	44409186	F 3015/6 A 180	-	
			240	12,000	25,400	10	44409246	F 3015/6 A 240	-	
			320	12,000	25,400	10	44409326	F 3015/6 A 320	-	
	20	A	40	12,000	25,400	10	47802247	F 3020/6 A 40	-	
			60	12,000	25,400	10	47802248	F 3020/6 A 60	-	
			150	12,000	25,400	10	47802249	F 3020/6 A 150	-	
			180	12,000	25,400	10	47802250	F 3020/6 A 180	-	
			240	12,000	25,400	10	47802251	F 3020/6 A 240	-	
	30	A	60	12,000	25,400	10	47802252	F 3020/6 A 320	-	
			60	12,000	25,400	10	44411066	F 3030/6 A 60	-	
			80	12,000	25,400	10	44411086	F 3030/6 A 80	-	
			120	12,000	25,400	10	44411126	F 3030/6 A 120	-	
			150	12,000	25,400	10	44411156	F 3030/6 A 150	-	
			180	12,000	25,400	10	44411186	F 3030/6 A 180	-	
	40	10	A	60	9,600	19,100	10	44411246	F 3030/6 A 240	-
				80	9,600	19,100	10	44411326	F 3030/6 A 320	-
60				9,600	19,100	10	44403066	F 4010/6 A 60	-	
80				9,600	19,100	10	44403086	F 4010/6 A 80	-	
120				9,600	19,100	10	44403126	F 4010/6 A 120	-	
150				9,600	19,100	10	44403156	F 4010/6 A 150	-	
15		A	180	9,600	19,100	10	44403186	F 4010/6 A 180	-	
			240	9,600	19,100	10	44403246	F 4010/6 A 240	-	
			60	9,600	19,100	10	44404066	F 4015/6 A 60	-	
			80	9,600	19,100	10	44404086	F 4015/6 A 80	-	
			120	9,600	19,100	10	44404126	F 4015/6 A 120	-	
			150	9,600	19,100	10	44404156	F 4015/6 A 150	-	
20		A	180	9,600	19,100	10	44404186	F 4015/6 A 180	-	
			240	9,600	19,100	10	44404246	F 4015/6 A 240	-	
			320	9,600	19,100	10	44404326	F 4015/6 A 320	-	
			40	9,600	19,100	10	44408046	F 4020/6 A 40	-	
			60	9,600	19,100	10	44408066	F 4020/6 A 60	-	
			80	9,600	19,100	10	44408086	F 4020/6 A 80	-	
50	5	A	120	9,600	19,100	10	44408126	F 4020/6 A 120	-	
			150	9,600	19,100	10	44408156	F 4020/6 A 150	-	
			180	9,600	19,100	10	44408186	F 4020/6 A 180	-	
			240	9,600	19,100	10	44408246	F 4020/6 A 240	-	
			320	9,600	19,100	10	44408326	F 4020/6 A 320	-	
			60	7,000	15,200	10	44418066	F 5005/6 A 60	-	
			80	7,000	15,200	10	44418086	F 5005/6 A 80	-	
	10	A	120	7,000	15,200	10	44418126	F 5005/6 A 120	-	
			150	7,000	15,200	10	44418156	F 5005/6 A 150	-	
			180	7,000	15,200	10	44418186	F 5005/6 A 180	-	
			240	7,000	15,200	10	44418246	F 5005/6 A 240	-	
			320	7,000	15,200	10	44418326	F 5005/6 A 320	-	
			60	7,000	15,200	10	44505066	F 5010/6 A 60	-	
			80	7,000	15,200	10	44505086	F 5010/6 A 80	-	
	15	A	120	7,000	15,200	10	44505126	F 5010/6 A 120	-	
			150	7,000	15,200	10	44505156	F 5010/6 A 150	-	
			180	7,000	15,200	10	44505186	F 5010/6 A 180	-	
			240	7,000	15,200	10	44505246	F 5010/6 A 240	-	
15	A	320	7,000	15,200	10	44505326	F 5010/6 A 320	-		
		60	7,000	15,200	10	44506066	F 5015/6 A 60	-		
			80	7,000	15,200	10	44506086	F 5015/6 A 80	-	

Continued on next page

D [mm]	T [mm]	Abrasive	Grit size	Opt. RPM	Max. RPM		Item no.	Designation	Price/unit EUR	
50	15	A	120	7,000	15,200	10	44506126	F 5015/6 A 120	-	
			150	7,000	15,200	10	44506156	F 5015/6 A 150	-	
			180	7,000	15,200	10	44506186	F 5015/6 A 180	-	
			240	7,000	15,200	10	44506246	F 5015/6 A 240	-	
			320	7,000	15,200	10	44506326	F 5015/6 A 320	-	
	20	A	60	7,000	15,200	10	44504066	F 5020/6 A 60	-	
			80	7,000	15,200	10	44504086	F 5020/6 A 80	-	
			120	7,000	15,200	10	44504126	F 5020/6 A 120	-	
			150	7,000	15,200	10	44504156	F 5020/6 A 150	-	
			180	7,000	15,200	10	44504186	F 5020/6 A 180	-	
	30	A	60	7,000	15,200	10	44504326	F 5020/6 A 320	-	
			40	7,000	15,200	10	44411546	F 5030/6 A 40	-	
			60	7,000	15,200	10	44503066	F 5030/6 A 60	-	
			80	7,000	15,200	10	44503086	F 5030/6 A 80	-	
			120	7,000	15,200	10	44503126	F 5030/6 A 120	-	
			150	7,000	15,200	10	44503156	F 5030/6 A 150	-	
			180	7,000	15,200	10	44503186	F 5030/6 A 180	-	
			240	7,000	15,200	10	44503246	F 5030/6 A 240	-	
			320	7,000	15,200	10	44503326	F 5030/6 A 320	-	
	60	5	A	60	6,300	12,700	10	44419066	F 6005/6 A 60	-
				80	6,300	12,700	10	44419086	F 6005/6 A 80	-
120				6,300	12,700	10	44419126	F 6005/6 A 120	-	
150				6,300	12,700	10	44419156	F 6005/6 A 150	-	
180				6,300	12,700	10	44419186	F 6005/6 A 180	-	
240				6,300	12,700	10	44419246	F 6005/6 A 240	-	
320				6,300	12,700	10	44419326	F 6005/6 A 320	-	
15		A	60	6,300	12,700	10	44507066	F 6015/6 A 60	-	
			80	6,300	12,700	10	44507086	F 6015/6 A 80	-	
			120	6,300	12,700	10	44507126	F 6015/6 A 120	-	
			150	6,300	12,700	10	44507156	F 6015/6 A 150	-	
			240	6,300	12,700	10	44507246	F 6015/6 A 240	-	
20		A	320	6,300	12,700	10	44507326	F 6015/6 A 320	-	
			60	6,300	12,700	10	44508066	F 6020/6 A 60	-	
			80	6,300	12,700	10	44508086	F 6020/6 A 80	-	
			120	6,300	12,700	10	44508126	F 6020/6 A 120	-	
			150	6,300	12,700	10	44508156	F 6020/6 A 150	-	
30		A	240	6,300	12,700	10	44508246	F 6020/6 A 240	-	
			320	6,300	12,700	10	44508326	F 6020/6 A 320	-	
			40	6,300	12,700	10	44509046	F 6030/6 A 40	-	
			60	6,300	12,700	10	44509066	F 6030/6 A 60	-	
			80	6,300	12,700	10	44509086	F 6030/6 A 80	-	
			120	6,300	12,700	10	44509126	F 6030/6 A 120	-	
			150	6,300	12,700	10	44509156	F 6030/6 A 150	-	
40		A	180	6,300	12,700	10	44509186	F 6030/6 A 180	-	
			240	6,300	12,700	10	44509246	F 6030/6 A 240	-	
			320	6,300	12,700	10	44509326	F 6030/6 A 320	-	
			400	6,300	12,700	10	44509406	F 6030/6 A 400	-	
			60	6,300	12,700	10	44510066	F 6040/6 A 60	-	
			80	6,300	12,700	10	44510086	F 6040/6 A 80	-	
			120	6,300	12,700	10	44510126	F 6040/6 A 120	-	
50		A	150	6,300	12,700	10	44510156	F 6040/6 A 150	-	
			240	6,300	12,700	10	44510246	F 6040/6 A 240	-	
			40	6,300	12,700	10	44511046	F 6050/6 A 40	-	
			60	6,300	12,700	10	44511066	F 6050/6 A 60	-	

Continued on next page



Flap tools

Mounted flap wheels F



D [mm]	T [mm]	Abrasive	Grit size	Opt. RPM	Max. RPM		Item no.	Designation	Price/unit EUR
60	50	A	80	6,300	12,700	10	44511086	F 6050/6 A 80	-
			120	6,300	12,700	10	44511126	F 6050/6 A 120	-
			150	6,300	12,700	10	44511156	F 6050/6 A 150	-
			240	6,300	12,700	10	44511246	F 6050/6 A 240	-
			320	6,300	12,700	10	44511326	F 6050/6 A 320	-
80	5	A	60	4,800	9,500	10	47801807	F 8005/6 A 60	-
			80	4,800	9,500	10	47801514	F 8005/6 A 80	-
			120	4,800	9,500	10	47801624	F 8005/6 A 120	-
			150	4,800	9,500	10	47801562	F 8005/6 A 150	-
			180	4,800	9,500	10	47802769	F 8005/6 A 180	-
			240	4,800	9,500	10	44480240	F 8005/6 A 240	-
			320	4,800	9,500	10	44480320	F 8005/6 A 320	-
	10	A	60	4,800	9,500	10	47801575	F 8010/6 A 60	-
			80	4,800	9,500	10	47801110	F 8010/6 A 80	-
			120	4,800	9,500	10	47801576	F 8010/6 A 120	-
			150	4,800	9,500	10	47802867	F 8010/6 A 150	-
			180	4,800	9,500	10	47802868	F 8010/6 A 180	-
			240	4,800	9,500	10	47802869	F 8010/6 A 240	-
			320	4,800	9,500	10	47802857	F 8010/6 A 320	-
	15	A	60	4,800	9,500	10	44512066	F 8015/6 A 60	-
			80	4,800	9,500	10	44512086	F 8015/6 A 80	-
			120	4,800	9,500	10	44512126	F 8015/6 A 120	-
			150	4,800	9,500	10	44512156	F 8015/6 A 150	-
	20	A	60	4,800	9,500	10	44513066	F 8020/6 A 60	-
			80	4,800	9,500	10	44513086	F 8020/6 A 80	-
			120	4,800	9,500	10	44513126	F 8020/6 A 120	-
			150	4,800	9,500	10	44513156	F 8020/6 A 150	-
	30	A	40	4,800	9,500	10	44514046	F 8030/6 A 40	-
			60	4,800	9,500	10	44514066	F 8030/6 A 60	-
			80	4,800	9,500	10	44514086	F 8030/6 A 80	-
			120	4,800	9,500	10	44514126	F 8030/6 A 120	-
			150	4,800	9,500	10	44514156	F 8030/6 A 150	-
			240	4,800	9,500	10	44514246	F 8030/6 A 240	-
	40	A	320	4,800	9,500	10	44514326	F 8030/6 A 320	-
			60	4,800	9,500	10	44515066	F 8040/6 A 60	-
			80	4,800	9,500	10	44515086	F 8040/6 A 80	-
			120	4,800	9,500	10	44515126	F 8040/6 A 120	-
150			4,800	9,500	10	44515156	F 8040/6 A 150	-	
50	A	240	4,800	9,500	10	44515246	F 8040/6 A 240	-	
		40	4,800	9,500	10	44516046	F 8050/6 A 40	-	
		60	4,800	9,500	10	44516066	F 8050/6 A 60	-	
		80	4,800	9,500	10	44516086	F 8050/6 A 80	-	
		120	4,800	9,500	10	44516126	F 8050/6 A 120	-	
		150	4,800	9,500	10	44516156	F 8050/6 A 150	-	
		240	4,800	9,500	10	44516246	F 8050/6 A 240	-	
320	4,800	9,500	10	44516326	F 8050/6 A 320	-			



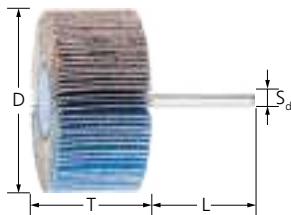

Zirconia alumina Z-COOL version

The flaps made of coated abrasive are arranged radially around the axis in a fan-type structure. For coarse grinding work with a high stock removal rate. Active grinding additives substantially improve the stock removal rate, prevent clogging and result in cooler grinding.

Special features:

- Highly flexible, enabling optimal adjustment to the contour.
- Consistently high stock removal rate over the entire tool life as new, aggressive abrasive is constantly exposed.
- Can be used face-down very close to edges and in corners thanks to the flat, moulded-core design.

D [mm]	T [mm]	Abrasive	Grit size	Opt. RPM	Max. RPM		Item no.	Designation	Price/unit EUR
Shank diameter of 6 x 40 mm [S_d x L]									
30	20	Z-COOL	60	12,000	25,400	10	44412066	F 3020/6 Z-COOL 60	-
			80	12,000	25,400	10	44412086	F 3020/6 Z-COOL 80	-
40	20	Z-COOL	60	9,600	19,100	10	44414066	F 4020/6 Z-COOL 60	-
			80	9,600	19,100	10	44414086	F 4020/6 Z-COOL 80	-
50	20	Z-COOL	60	7,000	15,200	10	44531066	F 5020/6 Z-COOL 60	-
			80	7,000	15,200	10	44531086	F 5020/6 Z-COOL 80	-
60	30	Z-COOL	60	6,300	12,700	10	44533066	F 6030/6 Z-COOL 60	-
			80	6,300	12,700	10	44533086	F 6030/6 Z-COOL 80	-
80	50	Z-COOL	60	4,800	9,500	10	44535066	F 8050/6 Z-COOL 60	-
			80	4,800	9,500	10	44535086	F 8050/6 Z-COOL 80	-

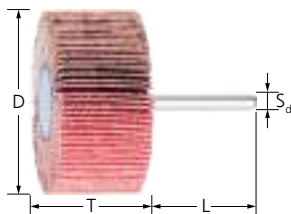

Ceramic oxide grain CO-COOL version

The flaps made of coated abrasive are arranged radially around the axis in a fan-type structure. Consistently high performance and aggressive grinding due to self-sharpening ceramic oxide grain. Active grinding additives improve the stock removal rate, prevent clogging and result in cooler grinding.

Special features:

- Highly flexible, enabling optimal adjustment to the contour.
- Consistently high stock removal rate over the entire tool life as new, aggressive abrasive is constantly exposed.
- Can be used face-down very close to edges and in corners thanks to the flat, moulded-core design.

D [mm]	T [mm]	Abrasive	Grit size	Opt. RPM	Max. RPM		Item no.	Designation	Price/unit EUR		
Shank diameter of 6 x 40 mm [S_d x L]											
20	10	CO-COOL	60	19,000	38,100	10	47802871	F 2010/6 CO-COOL 60	-		
			80	19,000	38,100	10	47802716	F 2010/6 CO-COOL 80	-		
			120	19,000	38,100	10	47802717	F 2010/6 CO-COOL 120	-		
30	10	CO-COOL	40	12,000	25,400	10	44402054	F 3010/6 CO-COOL 40	-		
			60	12,000	25,400	10	44402074	F 3010/6 CO-COOL 60	-		
			80	12,000	25,400	10	44402094	F 3010/6 CO-COOL 80	-		
			120	12,000	25,400	10	44402134	F 3010/6 CO-COOL 120	-		
			15	CO-COOL	40	12,000	25,400	10	44409054	F 3015/6 CO-COOL 40	-
					60	12,000	25,400	10	44409074	F 3015/6 CO-COOL 60	-
	80	12,000			25,400	10	44409094	F 3015/6 CO-COOL 80	-		
	120	12,000			25,400	10	44409134	F 3015/6 CO-COOL 120	-		
	20	CO-COOL			40	12,000	25,400	10	47802244	F 3020/6 CO-COOL 40	-
					60	12,000	25,400	10	47802245	F 3020/6 CO-COOL 60	-
			80	12,000	25,400	10	47802246	F 3020/6 CO-COOL 80	-		
			120	12,000	25,400	10	47802773	F 3020/6 CO-COOL 120	-		
40			20	CO-COOL	40	9,600	19,100	10	44408054	F 4020/6 CO-COOL 40	-
					60	9,600	19,100	10	44408074	F 4020/6 CO-COOL 60	-
	80	9,600			19,100	10	44408094	F 4020/6 CO-COOL 80	-		

Continued on next page



D [mm]	T [mm]	Abrasive	Grit size	Opt. RPM	Max. RPM		Item no.	Designation	Price/unit EUR
40	20	CO-COOL	120	9,600	19,100	10	44408134	F 4020/6 CO-COOL 120	-
50	30	CO-COOL	40	7,000	15,200	10	44411554	F 5030/6 CO-COOL 40	-
			60	7,000	15,200	10	44411574	F 5030/6 CO-COOL 60	-
			80	7,000	15,200	10	44411594	F 5030/6 CO-COOL 80	-
			120	7,000	15,200	10	44411634	F 5030/6 CO-COOL 120	-
60	15	CO-COOL	40	6,300	12,700	10	47802872	F 6015/6 CO-COOL 40	-
			60	6,300	12,700	10	47802873	F 6015/6 CO-COOL 60	-
			80	6,300	12,700	10	47802800	F 6015/6 CO-COOL 80	-
			120	6,300	12,700	10	47802874	F 6015/6 CO-COOL 120	-
	30	CO-COOL	40	6,300	12,700	10	44411754	F 6030/6 CO-COOL 40	-
			60	6,300	12,700	10	44411774	F 6030/6 CO-COOL 60	-
			80	6,300	12,700	10	44411794	F 6030/6 CO-COOL 80	-
			120	6,300	12,700	10	44411834	F 6030/6 CO-COOL 120	-

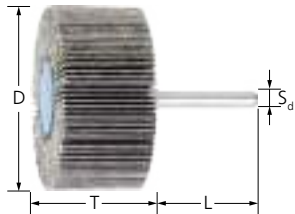

Silicon carbide SiC version

The flaps made of coated abrasive are arranged radially around the axis in a fan-type structure. For general grinding work. Particularly recommended for use on titanium alloys. Ideally suited for use in the aircraft industry, particularly when SiC is the only abrasive approved for use.



Special features:

- Highly flexible, enabling optimal adjustment to the contour.
- Consistently high stock removal rate over the entire tool life as new, aggressive abrasive is constantly exposed.
- Can be used face-down very close to edges and in corners thanks to the flat, moulded-core design.

D [mm]	T [mm]	Abrasive	Grit size	Opt. RPM	Max. RPM		Item no.	Designation	Price/unit EUR
Shank diameter of 6 x 40 mm [S_d x L]									
20	10	SiC	60	19,000	38,100	10	44400060	F 2010/6 SiC 60	-
			80	19,000	38,100	10	44400080	F 2010/6 SiC 80	-
			120	19,000	38,100	10	44400120	F 2010/6 SiC 120	-
			150	19,000	38,100	10	44400150	F 2010/6 SiC 150	-
30	10	SiC	60	12,000	25,400	10	44407066	F 3010/6 SiC 60	-
			80	12,000	25,400	10	44407086	F 3010/6 SiC 80	-
			120	12,000	25,400	10	44407126	F 3010/6 SiC 120	-
			150	12,000	25,400	10	44407156	F 3010/6 SiC 150	-
	15	SiC	60	12,000	25,400	10	44415060	F 3015/6 SiC 60	-
			80	12,000	25,400	10	44415080	F 3015/6 SiC 80	-
			120	12,000	25,400	10	44415120	F 3015/6 SiC 120	-
			150	12,000	25,400	10	44415150	F 3015/6 SiC 150	-
20	SiC	60	12,000	25,400	10	44420060	F 3020/6 SiC 60	-	
		80	12,000	25,400	10	44420080	F 3020/6 SiC 80	-	
		120	12,000	25,400	10	44420120	F 3020/6 SiC 120	-	
		150	12,000	25,400	10	44420150	F 3020/6 SiC 150	-	
40	20	SiC	60	9,600	19,100	10	44440060	F 4020/6 SiC 60	-
			80	9,600	19,100	10	44440080	F 4020/6 SiC 80	-
			120	9,600	19,100	10	44440120	F 4020/6 SiC 120	-
			150	9,600	19,100	10	44440150	F 4020/6 SiC 150	-
50	30	SiC	60	7,000	15,200	10	44450060	F 5030/6 SiC 60	-
			80	7,000	15,200	10	44450080	F 5030/6 SiC 80	-
			120	7,000	15,200	10	44450120	F 5030/6 SiC 120	-

Continued on next page

D [mm]	T [mm]	Abrasive	Grit size	Opt. RPM	Max. RPM		Item no.	Designation	Price/unit EUR
50	30	SiC	150	7,000	15,200	10	44450150	F 5030/6 SiC 150	-
60	15	SiC	60	6,300	12,700	10	44460060	F 6015/6 SiC 60	-
			80	6,300	12,700	10	44460080	F 6015/6 SiC 80	-
			120	6,300	12,700	10	44460120	F 6015/6 SiC 120	-
			150	6,300	12,700	10	44460150	F 6015/6 SiC 150	-
			30	SiC	60	6,300	12,700	10	44521066
	80	6,300	12,700		10	44521086	F 6030/6 SiC 80	-	
	120	6,300	12,700		10	44521126	F 6030/6 SiC 120	-	
	150	6,300	12,700		10	44521156	F 6030/6 SiC 150	-	

Mounted flap wheel set



FSO

Set of different mounted flap wheels in the aluminium oxide A variant with a shank diameter of 6 mm.

Contents:

Five each of the following mounted flap wheels: F 4015/6 A 80, F 4015/6 A 120, F 5015/6 A 60, F 5015/6 A 80, F 6030/6 A 60, F 6040/6 A 80, F 6040/6 A 150 and F 8030/6 A 60.

Special features:

- For getting to know and testing the comprehensive range.
- Coordinated selection of the most common versions.
- Promotional display box.

L [mm]	B [mm]	H [mm]		Item no.	Designation	Price/unit EUR
240	145	240	1	44590001	FSO 5400	-

Unmounted flap wheels FR

Safety notes

- As a rule, unmounted flap wheels should be used with the appropriate clamping flanges.
- The maximum permitted peripheral speed is determined as follows:
Unmounted flap wheels = 50 m/s
Unmounted flap wheels for angle grinders = 80 m/s
Flap drums = 32 m/s.
- The contact pressure must be significantly reduced if the specified optimum rotational speed is exceeded.
- For safety reasons, the maximum permitted rotational speed indicated must never be exceeded.



Wear eye protection!



Wear hearing protection!



Wear gloves!



Wear a dust mask!



Follow the safety instructions!



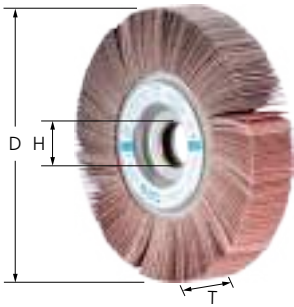

Aluminium oxide A version

The flaps made of coated abrasive are arranged radially around the axis in a fan-type structure. For general applications from coarse to fine grinding.

Special features:

- Highly flexible, enabling optimal adjustment to the contour. Can be used face-down very close to edges and in corners thanks to special clamping system.
- Consistently high stock removal rate over the entire tool life as new, aggressive abrasive is constantly exposed.
- Please order compatible arbor separately.

D [mm]	T [mm]	H [mm]	Abrasive	Grit size	Opt. RPM	Max. RPM		Item no.	Designation	Price/unit EUR				
100	30	25.4	A	40	5,500	9,500	2	44710041	FR 10030/25,4 A 40	-				
				60	5,500	9,500	2	44710061	FR 10030/25,4 A 60	-				
				80	5,500	9,500	2	44710081	FR 10030/25,4 A 80	-				
				120	5,500	9,500	2	44710121	FR 10030/25,4 A 120	-				
	50	25.4	A	40	5,500	9,500	2	44712041	FR 10050/25,4 A 40	-				
				60	5,500	9,500	2	44712061	FR 10050/25,4 A 60	-				
				80	5,500	9,500	2	44712081	FR 10050/25,4 A 80	-				
				120	5,500	9,500	2	44712121	FR 10050/25,4 A 120	-				
	150	30	25.4	A	40	3,500	6,300	2	44724040	FR 15030/25,4 A 40	-			
					60	3,500	6,300	2	44724060	FR 15030/25,4 A 60	-			
					80	3,500	6,300	2	44724080	FR 15030/25,4 A 80	-			
					120	3,500	6,300	2	44724120	FR 15030/25,4 A 120	-			
150					3,500	6,300	2	44724150	FR 15030/25,4 A 150	-				
50					25.4	A	40	3,500	6,300	2	44726040	FR 15050/25,4 A 40	-	
							60	3,500	6,300	2	44726060	FR 15050/25,4 A 60	-	
							80	3,500	6,300	2	44726080	FR 15050/25,4 A 80	-	
		120	3,500	6,300			2	44726120	FR 15050/25,4 A 120	-				
		150	3,500	6,300			2	44726150	FR 15050/25,4 A 150	-				
		240	3,500	6,300			2	44726240	FR 15050/25,4 A 240	-				
		165	30	25.4			A	40	3,200	5,700	2	44732041	FR 16530/25,4 A 40	-
								60	3,200	5,700	2	44732061	FR 16530/25,4 A 60	-
80					3,200	5,700		2	44732081	FR 16530/25,4 A 80	-			
120					3,200	5,700		2	44732121	FR 16530/25,4 A 120	-			
150					3,200	5,700		2	44732151	FR 16530/25,4 A 150	-			
240	3,200				5,700	2		44732241	FR 16530/25,4 A 240	-				
50	25.4		A	40	3,200	5,700	2	44731041	FR 16550/25,4 A 40	-				
				60	3,200	5,700	2	44731061	FR 16550/25,4 A 60	-				
				80	3,200	5,700	2	44731081	FR 16550/25,4 A 80	-				
				120	3,200	5,700	2	44731121	FR 16550/25,4 A 120	-				
				150	3,200	5,700	2	44731151	FR 16550/25,4 A 150	-				
				240	3,200	5,700	2	44731241	FR 16550/25,4 A 240	-				
200	30	44	A	60	2,600	4,700	2	44736061	FR 20030/44,0 A 60	-				
				80	2,600	4,700	2	44736081	FR 20030/44,0 A 80	-				
				120	2,600	4,700	2	44736121	FR 20030/44,0 A 120	-				
				240	2,600	4,700	2	44736241	FR 20030/44,0 A 240	-				
				50	44	A	60	2,600	4,700	2	44738061	FR 20050/44,0 A 60	-	
							80	2,600	4,700	2	44738081	FR 20050/44,0 A 80	-	
	120	2,600	4,700				2	44738121	FR 20050/44,0 A 120	-				
	150	2,600	4,700				2	44738151	FR 20050/44,0 A 150	-				
	240	2,600	4,700				2	44738241	FR 20050/44,0 A 240	-				
	250	50	44				A	60	2,100	3,800	1	44742061	FR 25050/44,0 A 60	-
				80	2,100	3,800		1	44742081	FR 25050/44,0 A 80	-			

Continued on next page

D [mm]	T [mm]	H [mm]	Abrasive	Grit size	Opt. RPM	Max. RPM		Item no.	Designation	Price/unit EUR
250	50	44	A	120	2,100	3,800	1	44742121	FR 25050/44,0 A 120	-
				150	2,100	3,800	1	44742151	FR 25050/44,0 A 150	-
				240	2,100	3,800	1	44742241	FR 25050/44,0 A 240	-
				320	2,100	3,800	1	44742321	FR 25050/44,0 A 320	-

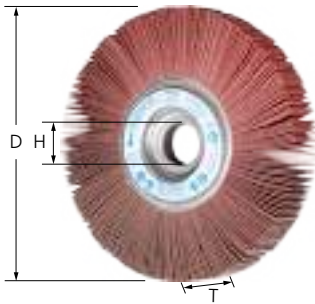

Ceramic oxide grain CO-COOL version

The flaps made of coated abrasive are arranged radially around the axis in a fan-type structure. Consistently high performance and aggressive grinding due to self-sharpening ceramic oxide grain. Active grinding additives improve the stock removal rate, prevent clogging and result in cooler grinding.

Special features:

- Highly flexible, enabling optimal adjustment to the contour. Can be used face-down very close to edges and in corners thanks to special clamping system.
- Consistently high stock removal rate over the entire tool life as new, aggressive abrasive is constantly exposed.
- Please order compatible arbor separately.

D [mm]	T [mm]	H [mm]	Abrasive	Grit size	Opt. RPM	Max. RPM		Item no.	Designation	Price/unit EUR
150	30	25.4	CO-COOL	40	3,500	6,300	2	44725204	FR 15030/25,4 CO-COOL 40	-
				60	3,500	6,300	2	44725206	FR 15030/25,4 CO-COOL 60	-
				80	3,500	6,300	2	44725208	FR 15030/25,4 CO-COOL 80	-
				120	3,500	6,300	2	44725212	FR 15030/25,4 CO-COOL 120	-
	50	25.4	CO-COOL	40	3,500	6,300	2	44727204	FR 15050/25,4 CO-COOL 40	-
				60	3,500	6,300	2	44727206	FR 15050/25,4 CO-COOL 60	-
				80	3,500	6,300	2	44727208	FR 15050/25,4 CO-COOL 80	-
				120	3,500	6,300	2	44727212	FR 15050/25,4 CO-COOL 120	-
165	30	25.4	CO-COOL	40	3,200	5,700	2	44733204	FR 16530/25,4 CO-COOL 40	-
				60	3,200	5,700	2	44733206	FR 16530/25,4 CO-COOL 60	-
				80	3,200	5,700	2	44733208	FR 16530/25,4 CO-COOL 80	-
				120	3,200	5,700	2	44733212	FR 16530/25,4 CO-COOL 120	-
	50	25.4	CO-COOL	40	3,200	5,700	2	44730304	FR 16550/25,4 CO-COOL 40	-
				60	3,200	5,700	2	44730306	FR 16550/25,4 CO-COOL 60	-
				80	3,200	5,700	2	44730308	FR 16550/25,4 CO-COOL 80	-
				120	3,200	5,700	2	44730312	FR 16550/25,4 CO-COOL 120	-

Arbor FR/VR

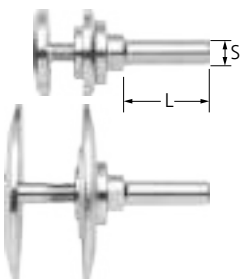

Version with clamping flange

For mounting PFERD unmounted flap wheels. The clamping flanges are designed to lie countersunk in the tool.

Special features:

- Can be used face-down very close to edges and in corners thanks to special clamping system.

Suitable for tool diameter [mm]	Suitable for hole diameter [mm]	S [mm]	L [mm]	Clamping range [mm]		Item no.	Designation	Price/unit EUR
100, 150, 165	25,4	12	40	25 – 50	1	44601225	FR/VR 12/25,4 100-165	-
200, 250	44	12	40	25 – 50	1	44601244	FR/VR 12/44,0 200-250	-

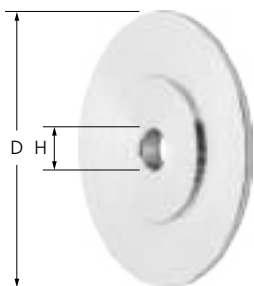

Reducing flanges for unmounted flap wheels

For mounting unmounted flap wheels and POLINOX grinding wheels on drive spindles. The clamping flanges are designed to lie countersunk in the tool.

Special features:

- Can be used face-down very close to edges and in corners thanks to special clamping system.
- Can be adapted to an existing drive spindle by drilling.

Suitable for tool diameter [mm]	D [mm]	H [mm]	Max. H [mm]		Item no.	Designation	Price/unit EUR
150, 165	40	12	22.2	1	44771225	RF FR 150-165 Bo. 12-22,2	-
200, 250	83	12	40	1	44771244	RF FR 200-250 Bo. 12-40	-

4

Unmounted flap wheels for angle grinders

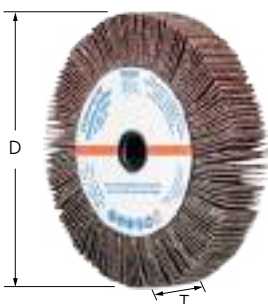

Aluminium oxide A version

The flaps made of coated abrasive are arranged radially around the axis in a fan-type structure. For general applications from coarse to fine grinding.

Special features:

- Can be mounted directly on the angle grinder without additional clamping devices (ideal for assembly shop operations).
- Consistently high stock removal rate over the entire tool life as new, aggressive abrasive is constantly exposed.
- Can be used face-down very close to edges and in corners. Highly flexible, enabling optimal adjustment to the contour.

D [mm]	T [mm]	Thread	Abrasive	Grit size	Opt. RPM	Max. RPM		Item no.	Designation	Price/unit EUR
115	20	5/8-11	A	40	7,500	13,300	2	47802558	FR WS 11520 5/8-11 A 40	-
				60	7,500	13,300	2	47802559	FR WS 11520 5/8-11 A 60	-
				80	7,500	13,300	2	47802560	FR WS 11520 5/8-11 A 80	-
				120	7,500	13,300	2	47802561	FR WS 11520 5/8-11 A 120	-
				180	7,500	13,300	2	47802821	FR WS 11520 5/8-11 A 180	-
				240	7,500	13,300	2	47802822	FR WS 11520 5/8-11 A 240	-
				320	7,500	13,300	2	47802823	FR WS 11520 5/8-11 A 320	-
		M14	A	40	7,500	13,300	2	44781504	FR WS 11520 M14 A 40	-
				60	7,500	13,300	2	44781506	FR WS 11520 M14 A 60	-
				80	7,500	13,300	2	44781508	FR WS 11520 M14 A 80	-
				120	7,500	13,300	2	44781512	FR WS 11520 M14 A 120	-
				180	7,500	13,300	2	44781518	FR WS 11520 M14 A 180	-
				240	7,500	13,300	2	44781524	FR WS 11520 M14 A 240	-
				320	7,500	13,300	2	44781532	FR WS 11520 M14 A 320	-
125	20	5/8-11	A	40	6,850	12,200	2	47802663	FR WS 12520 5/8-11 A 40	-
				60	6,850	12,200	2	47802664	FR WS 12520 5/8-11 A 60	-
				80	6,850	12,200	2	47802665	FR WS 12520 5/8-11 A 80	-
				120	6,850	12,200	2	47802666	FR WS 12520 5/8-11 A 120	-
				180	6,850	12,200	2	47802824	FR WS 12520 5/8-11 A 180	-
				240	6,850	12,200	2	47802825	FR WS 12520 5/8-11 A 240	-
				320	6,850	12,200	2	47802826	FR WS 12520 5/8-11 A 320	-
		M14	A	40	6,850	12,200	2	44782504	FR WS 12520 M14 A 40	-
				60	6,850	12,200	2	44782506	FR WS 12520 M14 A 60	-
				80	6,850	12,200	2	44782508	FR WS 12520 M14 A 80	-

Continued on next page



D [mm]	T [mm]	Thread	Abrasive	Grit size	Opt. RPM	Max. RPM		Item no.	Designation	Price/unit EUR
125	20	M14	A	120	6,850	12,200	2	44782512	FR WS 12520 M14 A 120	-
				180	6,850	12,200	2	44782518	FR WS 12520 M14 A 180	-
				240	6,850	12,200	2	44782524	FR WS 12520 M14 A 240	-
				320	6,850	12,200	2	44782532	FR WS 12520 M14 A 320	-

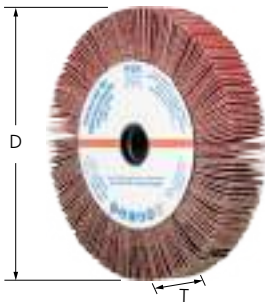

Ceramic oxide grain CO-COOL version

The flaps made of coated abrasive are arranged radially around the axis in a fan-type structure. Consistently high performance and aggressive grinding due to self-sharpening ceramic oxide grain. Active grinding additives improve the stock removal rate, prevent clogging and result in cooler grinding.

Special features:

- Can be mounted directly on the angle grinder without additional clamping devices (ideal for assembly shop operations).
- Consistently high stock removal rate over the entire tool life as new, aggressive abrasive is constantly exposed.
- Can be used face-down very close to edges and in corners. Highly flexible, enabling optimal adjustment to the contour.

D [mm]	T [mm]	Thread	Abrasive	Grit size	Opt. RPM	Max. RPM		Item no.	Designation	Price/unit EUR
115	20	5/8-11	CO-COOL	40	7,500	13,300	2	44781804	FR WS 11520 5/8-11 CO-COOL 40	-
				60	7,500	13,300	2	44781806	FR WS 11520 5/8-11 CO-COOL 60	-
				80	7,500	13,300	2	44781808	FR WS 11520 5/8-11 CO-COOL 80	-
				120	7,500	13,300	2	44781812	FR WS 11520 5/8-11 CO-COOL 120	-
		M14	CO-COOL	40	7,500	13,300	2	44781604	FR WS 11520 M14 CO-COOL 40	-
				60	7,500	13,300	2	44781606	FR WS 11520 M14 CO-COOL 60	-
				80	7,500	13,300	2	44781608	FR WS 11520 M14 CO-COOL 80	-
				120	7,500	13,300	2	44781612	FR WS 11520 M14 CO-COOL 120	-
125	20	5/8-11	CO-COOL	40	6,850	12,200	2	44782804	FR WS 12520 5/8-11 CO-COOL 40	-
				60	6,850	12,200	2	44782806	FR WS 12520 5/8-11 CO-COOL 60	-
				80	6,850	12,200	2	44782808	FR WS 12520 5/8-11 CO-COOL 80	-
				120	6,850	12,200	2	44782812	FR WS 12520 5/8-11 CO-COOL 120	-
		M14	CO-COOL	40	6,850	12,200	2	44782604	FR WS 12520 M14 CO-COOL 40	-
				60	6,850	12,200	2	44782606	FR WS 12520 M14 CO-COOL 60	-
				80	6,850	12,200	2	44782608	FR WS 12520 M14 CO-COOL 80	-
				120	6,850	12,200	2	44782612	FR WS 12520 M14 CO-COOL 120	-



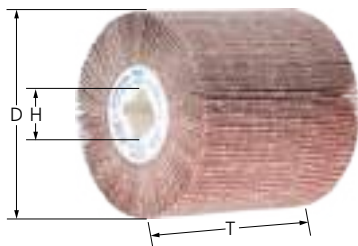

FR-W type

The flaps made of coated abrasive are arranged radially around the axis in a fan-type structure. Can be used for general work on medium and large metal surfaces. Achievement of homogeneous finishes (grinding patterns) on larger surfaces and contours in manual applications.



Special features:

- Suitable for all conventional keyway systems. The 19 mm hole diameter with four keyways fits all conventional drum grinders.
- Consistently high stock removal rate over the entire tool life as new, aggressive abrasive is constantly exposed.
- Can be used face-down very close to edges and in corners thanks to special clamping system. Highly flexible, enabling optimal adjustment to the contour.

D [mm]	T [mm]	H [mm]	Abrasive	Grit size	Opt. RPM	Max. RPM		Item no.	Designation	Price/unit EUR
100	100	19	A	40	3,800	6,100	1	44783040	FR-W 100100 A 40	-
				60	3,800	6,100	1	44783060	FR-W 100100 A 60	-
				80	3,800	6,100	1	44783080	FR-W 100100 A 80	-
				120	3,800	6,100	1	44783120	FR-W 100100 A 120	-
				150	3,800	6,100	1	44783150	FR-W 100100 A 150	-
				180	3,800	6,100	1	44783180	FR-W 100100 A 180	-

Drums, set FR-W



SET FR-W

Set with high-output electric grinding drum drive and PFERD tools for cleaning, brush matting and very fine grinding of large surfaces on stainless steel (INOX) components.

Contents:

One each of the following: electric grinding drum drive UWER 15/40 A-SI D19 with electronic rotational speed control (900–3,500 RPM), flap drum FR-W 100100 A 80, POLINOX grinding drum PNL-W 100100 A 180. Three empty storage compartments provide space for further drum tools from the PFERD range.

Special features:

- Optimal, stepless rotational speed regulation for the use of flap drums and POLINOX drums.
- Coordinated selection of the most common versions.

L [mm]	B [mm]	H [mm]		Item no.	Designation	Price/unit EUR
594	561	161	1	49350069	SET FR-W 100100 UWER 15/40 230 V	-

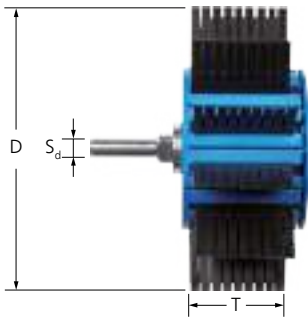

Grinding wheel PFL

The grinding wheel consists of a shank-mounted support and rubber flaps. It must be completed with appropriate abrasive flaps. The combination and arrangement of the abrasive and rubber flaps results in a highly flexible tool.

Special features:

- Ideal for blending different surface textures, fine grinding of radii, contours, curved areas or large surfaces.
- Creates a consistently high surface quality over the entire tool life, as new sharp abrasive is steadily released.

- Comfortable to use thanks to particularly lightweight design. Please order abrasive flaps separately in the required grit size.

D [mm]	T [mm]	S _d [mm]	Opt. RPM	Max. RPM		Item no.	Designation	Price/unit EUR
170	60	12	1,500	3,500	1	42800100	PFL 17060/12	-

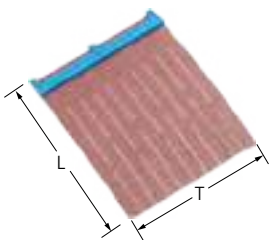

Abrasive flaps PFL-SL

Abrasive flaps with aluminium oxide A as the abrasive, suitable for POLIFLAP grinding wheels, for achieving visual effects ranging from coarse to very fine.



Special features:

- Ideal for blending different surface textures, fine grinding of radii, contours, curved areas or large surfaces.
- Comfortable to use as easy to replace once worn.

L [mm]	T [mm]	Abrasive	Grit size		Item no.	Designation	Price/unit EUR
75	60	A	60	12	42800110	PFL-SL A 60	-
			80	12	42800111	PFL-SL A 80	-
			100	12	42800112	PFL-SL A 100	-
			120	12	42800113	PFL-SL A 120	-
			150	12	42800114	PFL-SL A 150	-
			180	12	42800115	PFL-SL A 180	-
			220	12	42800116	PFL-SL A 220	-
			320	12	42800117	PFL-SL A 320	-

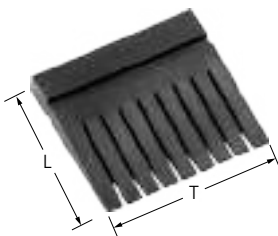

Rubber flaps PFL-GL

Rubber flaps to match the POLIFLAP grinding wheel. They lie between the abrasive flaps, and support the abrasive effect and the flexibility of the tool.

Special features:

- Comfortable to use as easy to replace once worn.

- The packaging unit corresponds to a complete POLIFLAP grinding wheel.

L [mm]	T [mm]		Item no.	Designation	Price/unit EUR
50	55	12	42800120	PFL-GL	-



Flap tools

Overlap slotted discs KS

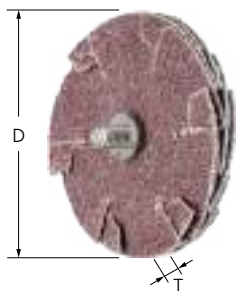

KS type

Ideal for face grinding. Special tool with aluminium oxide A as the abrasive for face grinding in grooves, fillets and slots. They are mounted via a central threaded hub.



Special features:

- Hard-to-reach areas can be accessed as the tool provides abrasive action on its top and bottom sides.
- High economic efficiency as tool can be changed quickly.
- Please order compatible arbor separately.

D [mm]	T [mm]	Abrasive	Grit size	Number of layers	Opt. RPM	Max. RPM	Suitable arbors		Item no.	Designation	Price/unit EUR
30	5	A	80	4	6,500	12,000	BO KS 30	20	42863408	KS 30-4 A 80	-
50	5	A	80	4	4,000	8,000	BO KS 50	20	42865408	KS 50-4 A 80	-

4

Arbor for overlap slotted discs BO KS

BO KS 30



BO KS

Matching arbor for overlap slotted discs.

BO KS 50



Special features:

- Reduced set-up work as the overlap slotted discs can be changed without unclamping the arbor from the collet.

Suitable for	S [mm]	L [mm]	Thread [mm]		Item no.	Designation	Price/unit EUR
KS 30-4 A 80	6	40	1/8 BSW	1	42700650	BO KS 30	-
KS 50-4 A 80	6	40	1/4-28 UNF	1	42700640	BO KS 50	-

Safety notes

- The maximum permitted peripheral speed is 20 m/s.
- For safety reasons, the maximum permitted rotational speed indicated must never be exceeded.



Wear eye protection!



Wear hearing protection!



Wear gloves!



Wear a dust mask!



Follow the safety instructions!

Matching tool diameter

POLISTAR can be stacked in several layers. Should be aligned at an offset from one another, so that the abrasive has the optimal effect. Select the tool diameter based on the relevant hole diameter:

PST 20/1.6 for hole dia. 7–15 mm

PST 30/1.6 for hole dia. 10–20 mm

PST 40/3 for hole dia. 15–25 mm

PST 50/3 for hole dia. 20–40 mm

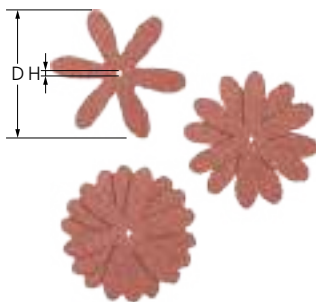

PST type

Flexible cross buffs with aluminium oxide A as the abrasive, developed especially for working on inner surfaces, e.g. holes and pipes. Can be stacked in several layers. Align at an offset from one another so that the abrasive has the optimal effect.



Special features:

- Highly flexible, enabling optimal adjustment to the contour.
- The tool dimensions ensure optimal processing of small internal diameters, in particular diameters of 7–40 mm.
- Order matching arbor separately.

D [mm]	H [mm]	Abrasive	Grit size	Opt. RPM	Max. RPM	Suitable arbors		Item no.	Designation	Price/unit EUR
20	1.6	A	60	15,000	38,000	BO 2,3/1-6, BO 3/1,6	100	42730206	PST 20/1,6 A 60	-
			80	15,000	38,000	BO 2,3/1-6, BO 3/1,6	100	42730208	PST 20/1,6 A 80	-
			120	15,000	38,000	BO 2,3/1-6, BO 3/1,6	100	42730212	PST 20/1,6 A 120	-
30	1.6	A	60	9,500	25,000	BO 2,3/1-6, BO 3/1,6	100	42730306	PST 30/1,6 A 60	-
			80	9,500	25,000	BO 2,3/1-6, BO 3/1,6	100	42730308	PST 30/1,6 A 80	-
			120	9,500	25,000	BO 2,3/1-6, BO 3/1,6	100	42730312	PST 30/1,6 A 120	-
40	3	A	60	7,200	19,000	BO 6/3 1-6	100	42730406	PST 40/3,0 A 60	-
			80	7,200	19,000	BO 6/3 1-6	100	42730408	PST 40/3,0 A 80	-
			120	7,200	19,000	BO 6/3 1-6	100	42730412	PST 40/3,0 A 120	-
50	3	A	60	5,700	15,000	BO 6/3 1-6	100	42730506	PST 50/3,0 A 60	-
			80	5,700	15,000	BO 6/3 1-6	100	42730508	PST 50/3,0 A 80	-
			120	5,700	15,000	BO 6/3 1-6	100	42730512	PST 50/3,0 A 120	-

Safety notes

- For safety reasons, the maximum permitted rotational speed indicated must never be exceeded.



Wear eye protection!



Wear hearing protection!



Wear a dust mask!



Wear gloves!



Follow the safety instructions!

Matching tool diameter

Select the tool diameter based on the respective pipe's inner diameter:

PST-T dia. of 50 mm for an inner pipe dia. of 35–40 mm

PST-T dia. of 60 mm for an inner pipe dia. of 40–45 mm

PST-T dia. of 70 mm for an inner pipe dia. of 45–50 mm

PST-T dia. of 80 mm for an inner pipe dia. of 50–55 mm

PST-T dia. of 90 mm for an inner pipe dia. of 55–60 mm

PST-T dia. of 100 mm for an inner pipe dia. of 60–65 mm

Suitable grit size

Select the correct grit size for the desired roughness:

Grit size 60 = 1.0–1.3 μm R_a

Grit size 120 = 0.6–1.0 μm R_a

Grit size 180 = 0.4–0.6 μm R_a

Grit size 240 = 0.3–0.4 μm R_a

Grit size 320 = 0.2–0.3 μm R_a



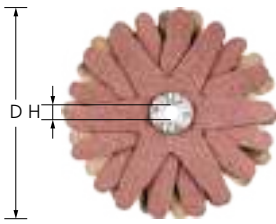

PST-T type

Multi-layered cross buffs with aluminium oxide A as the abrasive that are riveted together. They are used especially for working on the inner surfaces of pipes and pipe bends. Particularly suitable for work on inner surfaces.



Special features:

- Highly flexible, enabling optimal adjustment to the contour.
- The tool dimensions ensure optimal processing of small internal diameters, in particular diameters of 7–40 mm.

D [mm]	H [mm]	Abrasive	Grit size	Number of layers	Opt. RPM	Max. RPM	Suitable arbors		Item no.	Designation	Price/unit EUR
50	4	A	60	6	3,000	7,650	BO 6/4 0-10	10	42732063	PST-T 50/4 4 A 60	-
			120	6	3,000	7,650	BO 6/4 0-10	10	42732066	PST-T 50/4 6 A 120	-
			180	6	3,000	7,650	BO 6/4 0-10	10	42732068	PST-T 50/4 6 A 180	-
			240	6	3,000	7,650	BO 6/4 0-10	10	42732069	PST-T 50/4 6 A 240	-
			320	6	3,000	7,650	BO 6/4 0-10	10	42732070	PST-T 50/4 6 A 320	-
60	4	A	60	6	2,500	6,350	BO 6/4 0-10	10	42732083	PST-T 60/4 4 A 60	-
			120	6	2,500	6,350	BO 6/4 0-10	10	42732086	PST-T 60/4 6 A 120	-
			180	6	2,500	6,350	BO 6/4 0-10	10	42732088	PST-T 60/4 6 A 180	-
			240	6	2,500	6,350	BO 6/4 0-10	10	42732089	PST-T 60/4 6 A 240	-
			320	6	2,500	6,350	BO 6/4 0-10	10	42732090	PST-T 60/4 6 A 320	-
70	4	A	60	6	2,200	5,450	BO 6/4 0-10	10	42732103	PST-T 70/4 4 A 60	-
			120	6	2,200	5,450	BO 6/4 0-10	10	42732106	PST-T 70/4 6 A 120	-
			180	6	2,200	5,450	BO 6/4 0-10	10	42732108	PST-T 70/4 6 A 180	-
			240	6	2,200	5,450	BO 6/4 0-10	10	42732109	PST-T 70/4 6 A 240	-
			320	6	2,200	5,450	BO 6/4 0-10	10	42732110	PST-T 70/4 6 A 320	-
80	4	A	60	6	1,900	4,750	BO 6/4 0-10	10	42732123	PST-T 80/4 4 A 60	-
			120	6	1,900	4,750	BO 6/4 0-10	10	42732126	PST-T 80/4 6 A 120	-
			180	6	1,900	4,750	BO 6/4 0-10	10	42732128	PST-T 80/4 6 A 180	-
			240	6	1,900	4,750	BO 6/4 0-10	10	42732129	PST-T 80/4 6 A 240	-
90	5	A	60	8	1,700	4,250	BO 6/5 0-10	10	42732143	PST-T 90/5 4 A 60	-
			120	8	1,700	4,250	BO 6/5 0-10	10	42732146	PST-T 90/5 8 A 120	-
			180	8	1,700	4,250	BO 6/5 0-10	10	42732148	PST-T 90/5 8 A 180	-
			240	8	1,700	4,250	BO 6/5 0-10	10	42732149	PST-T 90/5 8 A 240	-
			320	8	1,700	4,250	BO 6/5 0-10	10	42732150	PST-T 90/5 8 A 320	-
100	5	A	60	8	1,500	3,820	BO 6/5 0-10	10	42732163	PST-T 100/5 4 A 60	-
			120	8	1,500	3,820	BO 6/5 0-10	10	42732166	PST-T 100/5 8 A 120	-
			180	8	1,500	3,820	BO 6/5 0-10	10	42732168	PST-T 100/5 8 A 180	-
			240	8	1,500	3,820	BO 6/5 0-10	10	42732169	PST-T 100/5 8 A 240	-



Flap tools

Arbor for POLISTAR and POLISTAR-TUBE



BO

Matching arbor for POLISTAR and POLISTAR-TUBE.

Special features:

- High economic efficiency as tool can be changed quickly.

Suitable for hole diameter [mm]	S [mm]	L [mm]	Clamping range [mm]		Item no.	Designation	Price/unit EUR
1,6	2.34	43	1 – 5	10	42460023	BO 2,3/1,6 1-5	-
	3	43	1 – 5	10	42460030	BO 3/1,6 1-5	-
3	6	40	1 – 6	1	42400003	BO 6/3 1-6	-
4	6	25	0 – 10	1	42400004	BO 6/4 0-10	-
5	6	25	0 – 10	1	42400005	BO 6/5 0-10	-



Safety notes



Wear eye protection!



Wear a dust mask!



Wear hearing protection!



Follow the safety instructions!



Wear gloves!



Flexible sanding sticks



Flexible sanding sticks SF/SF-R

Flexible sanding sticks with silicon carbide SiC for machining components with lots of contours, hard-to-reach areas and narrow slots. They are excellently suited for use in engine construction and turbine construction as well as in tool and mould-making.



Special features:

- Highly flexible, enabling optimal adjustment to the contour.
- Different surface quality levels from coarse to very fine can be successively achieved.



L [mm]	B [mm]	H [mm]	Abrasive	Grit size		Item no.	Designation	Price/unit EUR
SF-R – with radius								
147	15	5	SiC	80	10	40110020	SF-R 147-15-5 SiC 80	-
				100	10	40110021	SF-R 147-15-5 SiC 100	-
				120	10	40110022	SF-R 147-15-5 SiC 120	-
				180	10	40110023	SF-R 147-15-5 SiC 180	-
				240	10	40110024	SF-R 147-15-5 SiC 240	-
				320	10	40110025	SF-R 147-15-5 SiC 320	-
				1000	10	40110026	SF-R 147-15-5 SiC 1000	-
180	19	5	SiC	80	10	40110001	SF-R 180-19-5 SiC 80	-
				100	10	40110002	SF-R 180-19-5 SiC 100	-
				120	10	40110003	SF-R 180-19-5 SiC 120	-
				180	10	40110004	SF-R 180-19-5 SiC 180	-
				240	10	40110005	SF-R 180-19-5 SiC 240	-
				320	10	40110006	SF-R 180-19-5 SiC 320	-
				1000	10	40110007	SF-R 180-19-5 SiC 1000	-
SF – without radius								
180	28	5	SiC	80	10	40110040	SF 180-28-5 SiC 80	-
				100	10	40110041	SF 180-28-5 SiC 100	-
				120	10	40110042	SF 180-28-5 SiC 120	-
				180	10	40110043	SF 180-28-5 SiC 180	-
				240	10	40110044	SF 180-28-5 SiC 240	-
				320	10	40110045	SF 180-28-5 SiC 320	-
				1000	10	40110046	SF 180-28-5 SiC 1000	-

Sanding sticks

Ceramic fibre files

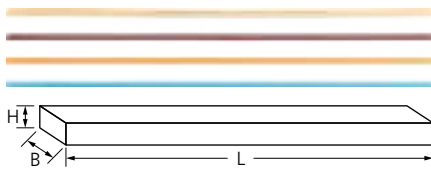



KFF

Ceramic fibre files are made of high-grade ceramic fibres embedded in a special resinoid bond. For work on surfaces, hard-to-reach areas and difficult geometries in tool and mould-making.





Special features:

- High economic efficiency due to high abrasive performance and long tool life.
- For maximum stock removal rate, use the file at a 45° angle. Can be used with manual filing tools from catalogue section 9.
- Colour code for the sizes: 180 = gold; 280 = light brown; 400 = orange; 700 = blue.

H [mm]	B [mm]	L [mm]	Abrasive	Grit size		Item no.	Designation	Price/unit EUR
Flat 								
0.5	4	150	A	180	1	40100018	KFF 0,5 x 4 x 150 A 180	-
				280	1	40100028	KFF 0,5 x 4 x 150 A 280	-
				400	1	40100040	KFF 0,5 x 4 x 150 A 400	-
				700	1	40100070	KFF 0,5 x 4 x 150 A 700	-
	6	150	A	180	1	40100318	KFF 0,5 x 6 x 150 A 180	-
				280	1	40100328	KFF 0,5 x 6 x 150 A 280	-
				400	1	40100340	KFF 0,5 x 6 x 150 A 400	-
				700	1	40100370	KFF 0,5 x 6 x 150 A 700	-
1	4	150	A	180	1	40100118	KFF 1,0 x 4 x 150 A 180	-
				280	1	40100128	KFF 1,0 x 4 x 150 A 280	-
				400	1	40100140	KFF 1,0 x 4 x 150 A 400	-
				700	1	40100170	KFF 1,0 x 4 x 150 A 700	-
	6	150	A	180	1	40100418	KFF 1,0 x 6 x 150 A 180	-
				280	1	40100428	KFF 1,0 x 6 x 150 A 280	-
				400	1	40100440	KFF 1,0 x 6 x 150 A 400	-
				700	1	40100470	KFF 1,0 x 6 x 150 A 700	-
	10	150	A	180	1	40100618	KFF 1,0 x 10 x 150 A 180	-
				280	1	40100628	KFF 1,0 x 10 x 150 A 280	-
				400	1	40100640	KFF 1,0 x 10 x 150 A 400	-
				700	1	40100670	KFF 1,0 x 10 x 150 A 700	-
2	4	150	A	180	1	40100218	KFF 2,0 x 4 x 150 A 180	-
				280	1	40100228	KFF 2,0 x 4 x 150 A 280	-
				400	1	40100240	KFF 2,0 x 4 x 150 A 400	-
				700	1	40100270	KFF 2,0 x 4 x 150 A 700	-
	6	150	A	180	1	40100518	KFF 2,0 x 6 x 150 A 180	-
				280	1	40100528	KFF 2,0 x 6 x 150 A 280	-
				400	1	40100540	KFF 2,0 x 6 x 150 A 400	-
				700	1	40100570	KFF 2,0 x 6 x 150 A 700	-
Round 								
2.35	-	150	A	180	1	40100802	KFF RD 2,35 x 150 A 180	-
				280	1	40100804	KFF RD 2,35 x 150 A 280	-
				400	1	40100806	KFF RD 2,35 x 150 A 400	-
				700	1	40100808	KFF RD 2,35 x 150 A 700	-
3	-	150	A	180	1	40100822	KFF RD 3 x 150 A 180	-
				280	1	40100824	KFF RD 3 x 150 A 280	-
				400	1	40100826	KFF RD 3 x 150 A 400	-
				700	1	40100828	KFF RD 3 x 150 A 700	-

Continued on next page

H [mm]	B [mm]	L [mm]	Abrasive	Grit size		Item no.	Designation	Price/unit EUR
Three square								
3	3	150	A	180	1	40100922	KFF DKT 3 x 3 x 3 x 150 A 180	-
				280	1	40100924	KFF DKT 3 x 3 x 3 x 150 A 280	-
				400	1	40100926	KFF DKT 3 x 3 x 3 x 150 A 400	-
				700	1	40100928	KFF DKT 3 x 3 x 3 x 150 A 700	-



Non-woven tools

General information



Non-woven abrasives

Non-woven abrasives consist of

- ① Abrasive grain,
- ② Polyamide fibres and
- ③ Synthetic resins.

The non-woven fibre structure is impregnated/interspersed with resin and abrasive grain. The even distribution of the abrasive grain within the non-woven mixture guarantees a continuous supply of fresh, sharp abrasive grain during the entire grinding operation.

The very loose connections between the individual fibres ensures a high level of flexibility and gives a strong spring-type effect to the non-woven material. It is flexible and supple, and leaves behind a very distinctive surface structure. The satin-finished grinding result is unique and cannot be achieved with other abrasives.

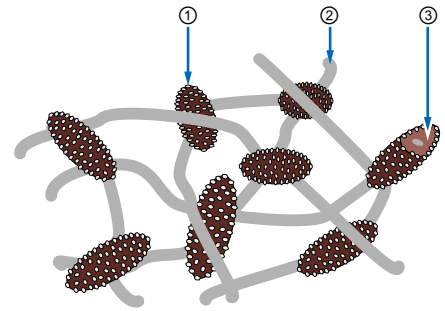

Grit sizes

Non-woven abrasives are labelled according to the following scheme:

PFERD	Grit size [mesh]
very coarse	50–80
coarse	80–100
medium	100–180
fine	180–220
very fine	220–400

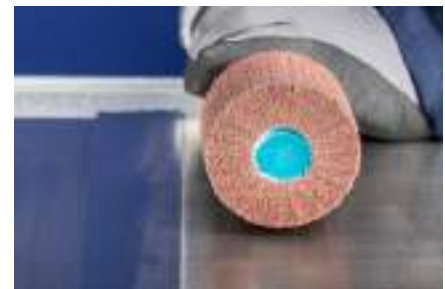

Abrasive

Even though non-woven abrasive has a completely different structure to coated abrasives, the same abrasive materials are used for both tool groups.

Aluminium oxide (Al₂O₃)

Aluminium oxide (Al₂O₃) is very durable, achieves a top tool life and is very aggressive on hardened steel. The surface generated is characterized by a higher level of shine. When used on aluminium, discolouration is prevented.

Silicon carbide (SiC)

Silicon carbide (SiC) is even sharper, harder and has better cutting characteristics. It quickly produces a finer, long-lasting slightly matte grinding pattern on the surfaces of many materials.

Safety notes

- For safety reasons, the maximum permitted rotational speed indicated must never be exceeded.
- Use **POLINOX unitized wheels PNER** at a recommended cutting speed of 15–35 m/s.
- Use **POLINOX convolute wheels PNK** at a recommended cutting speed of 20 m/s. The wound construction of the tool requires that the indicated running direction is strictly observed. Non-compliance with the running direction will lead to destruction of the tool and carries an increased risk of accidents.
- Use **POLINOX mounted/unmounted grinding wheels and cross buffs** at a recommended cutting speed of 10–20 m/s.
- Use **POLICLEAN tools** at a recommended cutting speed of 15–20 m/s.



Wear eye protection!



Wear hearing protection!



Wear gloves!



Wear a dust mask!



Follow the safety instructions!



Available types and hardness grades



PNER

Thanks to different combinations of compaction, fibres, grit and the appropriate bond, this tool can be used for a wide range of applications for work on surfaces, from relatively coarse grinding to preparing the surface for polishing.



PNG

The non-woven abrasive is made of several very wavy arranged strips of non-woven abrasive material, wound around a core. The wavy structure of the non-woven abrasive material permits seamless brush matting of surfaces.



PNK

The non-woven abrasive is wound around a core and foamed up. The tools can be optimized for a variety of applications by implementing different foam, fibre, grain and bond combinations. Uses range from fine deburring to preparation for polishing.



PNR

The non-woven abrasive material is arranged in multiple (axial) disc layers. Since the individual non-woven discs are not interconnected, the abrasive surface adapts easily to different workpiece contours, e.g. when working on profiles or pipes.



PNL

The non-woven abrasive material is arranged in multiple radial flaps. A long tool life is achieved through the very dense packing of the flaps. The main area of application of the tool is for surface work.



PNST

The non-woven abrasive is star-shaped and stacked in layers which are connected in the centre. Particularly suitable for narrow application areas and hard-to-reach places such as drilled holes and indentations.



PNZ

The non-woven abrasive material is arranged in multiple radial flaps, with abrasive cloth interlayers. The flap structure facilitates improved stock removal and achieves a coarser surface finish.



Non-woven tools

General information on POLINOX unitized wheels and discs PNER



Available types

W Soft
Soft version with excellent adaptability. The durability, grinding performance and very high surface quality are maintained at the same time. Very well-suited to work on contours.

MW Medium-soft
Medium-soft version with increased edge strength and tool life for coarse blending and polishing tasks. Well-suited to work on contours.

MH Medium-hard
Medium-hard version with increased edge strength and tool life for coarse deburring and cleaning applications.

H Hard
Hard version with very high stock removal rate, good edge strength and long tool life for tough deburring and polishing applications.

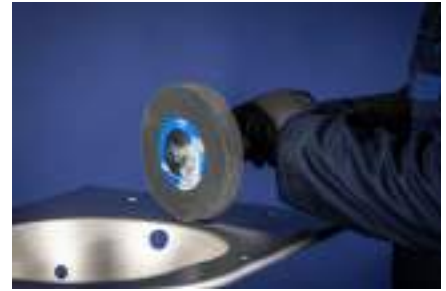

Comparison table

PFERD PNER				3M	Standard Abrasives	Norton	BIBIELLE
Type	Colour code	Abrasive	Grit				
Soft	W	SiC	fine	EXL 2S fine	532	UW1-2SF or Nex-2SF	BUH 2SF
		A	coarse	EXL 2A medium	521	UW1-2AM or Nex-2AM	BUH 2AM
Medium-soft	MW	SiC	fine	EXL 4S fine or SST 3S fine	632	UW1-4SF	BUH 3SF
		A	fine	EXL 4A fine or SST 3A fine	631	UW1-4AF	-
Medium-hard	MH	A	fine	Cut & polish 5A fine or SST 5A fine	731	UW1-6AF or Nex-6AF	-
Hard	H	A	fine	Cut & polish 7A medium or 9A medium	821	UW1-8AM or Nex-8AM	BUH 6AM
		A	coarse	Cut & polish 7A coarse or 9A coarse	811	UW1-8AC or Nex-8AC	BUH 8AC

4



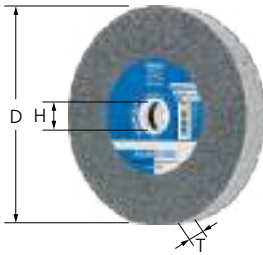

PNER type for straight grinders, flexible shaft drives and bench grinders

Consist of multiple heavily compressed, non-woven layers, which are bonded together by a special grain/resin system. Particularly suitable for working on soft metals, alloyed and high-alloy steels and titanium alloy.



Special features:

- High economic efficiency due to high abrasive performance and long tool life.
- Produces very good surface quality and can be profiled as desired, enabling optimal adjustment to the contour. Ideal for cleaning, deburring, blending and polishing.
- Type W = soft, MW = medium-soft, MH = medium-hard and H = hard.

D [mm]	T [mm]	H [mm]	Grit size	Version	Abrasive	Opt. RPM	Max. RPM	Suitable arbors		Item no.	Designation	Price/unit EUR	
Type for straight grinders, flexible shafts and bench grinders													
25	25	6	coarse	H	A	19,000	30,500	BO PNER 25 S6	10	44691001	PNER-H 2525-6 A G	-	
			fine	MH	A	19,000	30,500	BO PNER 25 S6	10	44691202	PNER-MH 2525-6 A F	-	
				H	A	19,000	30,500	BO PNER 25 S6	10	44691002	PNER-H 2525-6 A F	-	
50	3	6	fine	H	A	9,500	15,300	BO 6/6 3-10	10	44691005	PNER-H 5003-6 A F	-	
75	3	6	coarse	W	A	6,400	10,200	BO 6/6 3-10	10	47803085	PNER-W 7503-6 A G	-	
			fine	W	SiC	6,400	10,200	-	10	47803086	PNER-W 7503-6 SiC F	-	
				MW	SiC	6,400	10,200	-	10	47803087	PNER-MW 7503-6 SiC F	-	
				MH	A	6,400	10,200	BO 6/6 3-10	10	47803088	PNER-MH 7503-6 A F	-	
			coarse	H	A	6,400	10,200	BO 6/6 3-10	10	47803089	PNER-H 7503-6 A G	-	
		fine	H	A	6,400	10,200	BO 6/6 3-10	10	44691010	PNER-H 7503-6 A F	-		
		6	6	coarse	W	A	6,400	10,200	-	5	44691621	PNER-W 7506-6 A G	-
				fine	W	SiC	6,400	10,200	-	5	44691627	PNER-W 7506-6 SiC F	-
					MW	A	6,400	10,200	BO 6/6 3-10	5	44691422	PNER-MW 7506-6 A F	-
				MW	SiC	6,400	10,200	-	5	44691427	PNER-MW 7506-6 SiC F	-	
MH	A			6,400	10,200	BO 6/6 3-10	5	44691222	PNER-MH 7506-6 A F	-			
coarse	H	A	6,400	10,200	BO 6/6 3-10	5	44691021	PNER-H 7506-6 A G	-				
13	6	coarse	W	A	6,400	10,200	BO 6/6 3-10	5	44691641	PNER-W 7513-6 A G	-		
		fine	W	SiC	6,400	10,200	-	5	44691647	PNER-W 7513-6 SiC F	-		
			MW	A	6,400	10,200	BO 6/6 3-10	5	44691442	PNER-MW 7513-6 A F	-		
			MW	SiC	6,400	10,200	-	5	44691447	PNER-MW 7513-6 SiC F	-		
		MH	A	6,400	10,200	BO 6/6 3-10	5	44691242	PNER-MH 7513-6 A F	-			
		coarse	H	A	6,400	10,200	BO 6/6 3-10	5	44691041	PNER-H 7513-6 A G	-		
		150	25	25.4	fine	W	SiC	3,200	5,100	BO 12/20	1	44691667	PNER-W 15025-25,4 SiC F
MW	A					3,200	5,100	BO 12/20	1	44691462	PNER-MW 15025-25,4 A F	-	
	SiC					3,200	5,100	BO 12/20	1	44691467	PNER-MW 15025-25,4 SiC F	-	
MH	A					3,200	5,100	BO 12/20	1	44691262	PNER-MH 15025-25,4 A F	-	
coarse	H				A	3,200	5,100	BO 12/20	1	44691061	PNER-H 15025-25,4 A G	-	



Non-woven tools

Arbor for POLINOX unitized/convolute wheels

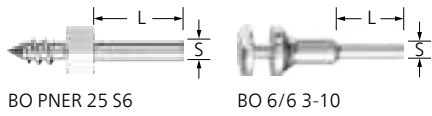

BO PNER 25 S6

BO 6/6 3-10

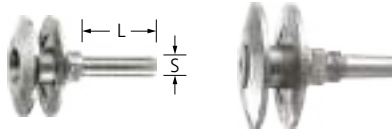

BO 12/20 10-50

BO MK 1/20 10-50

Arbor BO

Matching arbor for POLINOX unitized wheels.

Special features:

- High economic efficiency as tool can be changed quickly.

Suitable for hole diameter [mm]	S [mm]	L [mm]	Clamping range [mm]		Item no.	Designation	Price/unit EUR
6	6	25	-	1	42700256	BO PNER 25 S6	-
			3 – 10	1	42400006	BO 6/6 3-10	-
20	12	35	10 – 50	1	42400012	BO 12/20 10-50	-
	-	-	10 – 50	1	42400062	BO MK 1/20 10-50	-

4

POLINOX unitized wheels PNER

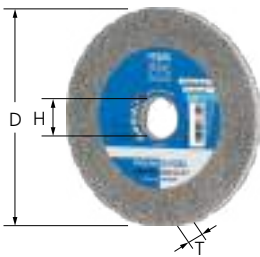

PNER type for speed-adjustable angle grinders and fillet weld grinders

Consist of multiple heavily compressed, non-woven layers, which are bonded together by a special grain/resin system. Particularly suitable for work on fillet welds and hard-to-reach slots or indentations.

Special features:

- High economic efficiency due to high abrasive performance and long tool life.
- Produces very good surface quality. Can be profiled as desired, enabling optimal adjustment to the contour.
- Ideal for cleaning, deburring, blending and polishing.

D [mm]	T [mm]	H [mm]	Grit size	Version	Abrasive	Opt. RPM	Max. RPM		Item no.	Designation	Price/unit EUR
Type for angle grinders and fillet weld grinders											
125	6	22.23	fine	MW (medium-soft)	A	4,500	6,100	5	44691453	PNER-MW 12506-22,2 A F	-
				MH (medium-hard)	SiC	4,500	6,100	5	44691452	PNER-MW 12506-22,2 SiC F	-
				MH (medium-hard)	A	4,500	6,100	5	44691252	PNER-MH 12506-22,2 A F	-
			coarse	H (hard)	A	4,500	6,100	5	44691053	PNER-H 12506-22,2 A G	-
			fine	H (hard)	A	4,500	6,100	5	44691052	PNER-H 12506-22,2 A F	-
150	3	25.4	fine	MW (medium-soft)	SiC	3,800	5,100	5	44691628	PNER-MW 15003-25,4 SiC F	-
				MH (medium-hard)	SiC	3,800	5,100	5	44691629	PNER-MH 15003-25,4 SiC F	-
				H (hard)	A	3,800	5,100	5	44691630	PNER-H 15003-25,4 A F	-
	6	25.4	fine	W (soft)	SiC	3,800	5,100	5	44691631	PNER-W 15006-25,4 SiC F	-
				MW (medium-soft)	SiC	3,800	5,100	5	44691632	PNER-MW 15006-25,4 SiC F	-
				H (hard)	A	3,800	5,100	5	44691633	PNER-H 15006-25,4 A F	-
	13	12.7	fine	W (soft)	SiC	3,800	5,100	5	47802723	PNER-W 15013-12,7 SiC F	-
				MW (medium-soft)	SiC	3,800	5,100	5	47700200	PNER-MW 15013-12.7 SiC F	-
			MH (medium-hard)	SiC	3,800	5,100	5	47700201	PNER-MH 15013-12.7 SiC F	-	



PNER discs for speed-adjustable angle grinders

Consist of multiple heavily compressed, non-woven layers, which are glued to a backer and bonded together by a special grain/resin system. Particularly suitable for working on soft metals, alloyed and high-alloy steels and titanium alloys.



Special features:

- High economic efficiency due to high abrasive performance and long tool life.
- Produces very good surface quality. Can be profiled as desired, enabling optimal adjustment to the contour.
- Ideal for cleaning, deburring, blending and polishing.

D [mm]	T [mm]	H [mm]	Grit size	Version	Abrasive	Opt. RPM	Max. RPM		Item no.	Designation	Price/unit EUR
115	13	22.23	fine	W (soft)	SiC	6,000	10,000	5	44690732	DISC PNER-W 115-22,2 SiC F	-
				MW (medium-soft)	SiC	6,000	10,000	5	44690722	DISC PNER-MW 115-22,2 SiC F	-
				MH (medium-hard)	SiC	6,000	10,000	5	44690712	DISC PNER-MH 115-22,2 SiC F	-
125	13	22.23	fine	W (soft)	SiC	5,400	10,000	5	44690733	DISC PNER-W 125-22,2 SiC F	-
				MW (medium-soft)	SiC	5,400	10,000	5	44690723	DISC PNER-MW 125-22,2 SiC F	-
				MH (medium-hard)	SiC	5,400	10,000	5	44690713	DISC PNER-MH 125-22,2 SiC F	-



Non-woven tools

General information on POLINOX convolute wheels PNK



Available types

W Soft
Soft version with very good abrasive performance on contours. Very good for blending surfaces.

MW Medium-soft
Medium-soft version with increased flexibility and tool life for coarse blending applications and for light deburring and polishing work. Well-suited to work on contours.

MH Medium-hard
Medium-hard version with increased edge strength and tool life for coarse deburring applications and deburring, blending and cleaning work.

H Hard
Hard version with very high stock removal rate, good edge strength and long tool life for medium to heavy-duty deburring and polishing applications.

EH Extra-hard
Extra-hard version with excellent edge strength for demanding deburring work.



4

Comparison table

Type	PFERD PNK			3M	Standard Abrasives	Norton	BIBIELLE
	Colour code	Abrasive	Grit				
Soft	W	A	coarse	CP-WL 5AM	MF CV 5AM	MF CF 5AM	BCW-MF 5AM
Medium-soft	MW	SiC	fine	LDW 7SF	LDW 7SF	Series 2000 7SF	BCW-DB 7SF
Medium-hard	MH	SiC	fine	EXL Deburring 8SF	Deburring 8SF	Series 1000 8SF	BCW-DB 8SF
	MH	A	coarse	EXL Deburring 8AM	GP Plus 8AM	Series 1000 8AM	BCW-DB 8AM
Hard	H	SiC	fine	Deburring 9SF	EXL Deburring 9SF	Series 1000 9SF	BCW-DB 9SF
Extra-hard	EH	SiC	fine	XP-WL 10SF	GP Plus 10SF	Series 4000 9SF	BCW-DB 9SF-R

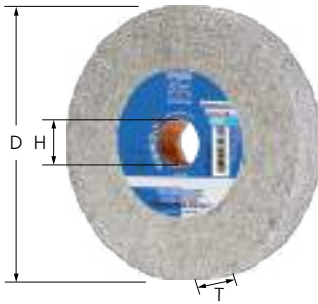

PNK type

Consist of spiral-shaped, non-woven abrasive which is wound around a core. Particularly suitable for working on soft metals, alloyed and high-alloy steels and titanium alloys, e.g. on turbine blades and for the removal of processing traces on surgical instruments.

Special features:

- High economic efficiency due to high abrasive performance and long tool life.
- Produces very good surface quality. Can be profiled as desired, enabling optimal adjustment to the contour.
- Ideal for cleaning, deburring, blending and polishing.

D [mm]	T [mm]	H [mm]	Grit size	Version	Abrasive	Opt. RPM	Max. RPM		Item no.	Designation	Price/unit EUR
150	13	25.4	fine	MW (medium-soft)	SiC	2,500	5,100	1	47802637	PNK-MW 15013-25,4 SiC F	-
				MH (medium-hard)	SiC	2,500	5,100	1	47802639	PNK-MH 15013-25,4 SiC F	-
			coarse	MH (medium-hard)	A	2,500	5,100	1	47802638	PNK-MH 15013-25,4 A G	-
				H (hard)	SiC	2,500	5,100	1	47802640	PNK-H 15013-25,4 SiC F	-
			EH (extra-hard)	SiC	2,500	5,100	1	47803030	PNK-EH 15013-25,4 SiC F	-	
				W (soft)	A	2,500	5,100	1	47802730	PNK W 15025-25,4 A G	-
	25	25.4	coarse	MW (medium-soft)	SiC	2,500	5,100	1	47802641	PNK-MW 15025-25,4 SiC F	-
				MH (medium-hard)	SiC	2,500	5,100	1	47802643	PNK-MH 15025-25,4 SiC F	-
			coarse	MH (medium-hard)	A	2,500	5,100	1	47802642	PNK-MH 15025-25,4 A G	-
				H (hard)	SiC	2,500	5,100	1	47802644	PNK-H 15025-25,4 SiC F	-
			EH (extra-hard)	SiC	2,500	5,100	1	47803031	PNK-EH 15025-25,4 SiC F	-	
				W (soft)	A	1,900	3,850	1	47802645	PNK-MW 20013-76,2 SiC F	-
200	13	76.2	fine	MW (medium-soft)	SiC	1,900	3,850	1	47802645	PNK-MW 20013-76,2 SiC F	-
				MH (medium-hard)	SiC	1,900	3,850	1	47802647	PNK-MH 20013-76,2 SiC F	-
			coarse	MH (medium-hard)	A	1,900	3,850	1	47802646	PNK-MH 20013-76,2 A G	-
				H (hard)	SiC	1,900	3,850	1	47802648	PNK-H 20013-76,2 SiC F	-
			EH (extra-hard)	SiC	1,900	3,850	1	47802882	PNK-EH 20013-76,2 SiC F	-	
				W (soft)	A	1,900	3,850	1	47803029	PNK-W 20025-76,2 A G	-
	25	76.2	coarse	MW (medium-soft)	SiC	1,900	3,850	1	47802649	PNK-MW 20025-76,2 SiC F	-
				MH (medium-hard)	SiC	1,900	3,850	1	47802651	PNK-MH 20025-76,2 SiC F	-
			coarse	MH (medium-hard)	A	1,900	3,850	1	47802650	PNK-MH 20025-76,2 A G	-
				H (hard)	SiC	1,900	3,850	1	47802652	PNK-H 20025-76,2 SiC F	-
			EH (extra-hard)	SiC	1,900	3,850	1	47802881	PNK-EH 20025-76,2 SiC F	-	
				W (soft)	A	1,900	3,850	1	47802732	PNK W 20050-76,2 A G	-
	50	76.2	coarse	MW (medium-soft)	SiC	1,900	3,850	1	47802653	PNK-MW 20050-76,2 SiC F	-
				MH (medium-hard)	SiC	1,900	3,850	1	47802655	PNK-MH 20050-76,2 SiC F	-
			coarse	MH (medium-hard)	A	1,900	3,850	1	47802654	PNK-MH 20050-76,2 A G	-
				H (hard)	SiC	1,900	3,850	1	47802656	PNK-H 20050-76,2 SiC F	-
			EH (extra-hard)	SiC	1,900	3,850	1	47802880	PNK-EH 20050-76,2 SiC F	-	
				W (soft)	A	1,900	3,850	1	47802732	PNK W 20050-76,2 A G	-



Non-woven tools

Clamping flanges for POLINOX convolute wheels PNK

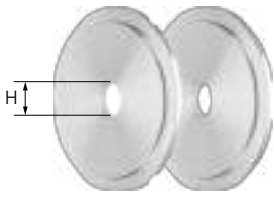

RF PNK

For mounting POLINOX convolute wheels PNK with a diameter of 200 mm on stationary machines such as double grinding machines (bench grinders).

Special features:

- High accuracy of fit.
- Hole can be expanded as desired.

Suitable for tool diameter [mm]	H [mm]		Item no.	Designation	Price/unit EUR
76,2	16.1	1	47601200	RF PNK 200 Bo. 16,1	-
	25.4	1	47601201	RF PNK 200 Bo. 25,4	-
	31.8	1	47601202	RF PNK 200 Bo. 31,8	-

POLINOX mounted grinding wheels

4



PNL type

The non-woven abrasive material is arranged in multiple radial flaps. A long tool life is achieved through the dense packing of the flaps. It is particularly used for surface work. Available in aluminium oxide A and silicon carbide (SiC).



Special features:

- Highly flexible, enabling optimal adjustment to the contour.
- Cool grinding and low thermal load on the workpiece.
- The open structure and high flexibility of the non-woven material prevents tool clogging.

D [mm]	T [mm]	S _d [mm]	L [mm]	Abrasive	Grit size	Opt. RPM	Max. RPM		Item no.	Designation	Price/unit EUR
Aluminium oxide A											
30	25	6	40	A	100	10,000	20,000	10	44653100	PNL 3025/6 A 100	-
					180	10,000	20,000	10	44653180	PNL 3025/6 A 180	-
					280	10,000	20,000	10	44653280	PNL 3025/6 A 280	-
40	20	6	40	A	80	7,500	15,000	10	44698505	PNL 4020/6 A 80	-
					100	7,500	15,000	10	44654100	PNL 4020/6 A 100	-
					180	7,500	15,000	10	44654180	PNL 4020/6 A 180	-
					280	7,500	15,000	10	44654280	PNL 4020/6 A 280	-
					360	7,500	15,000	10	44698506	PNL 4020/6 A 360	-
50	30	6	40	A	80	6,000	12,000	10	44698507	PNL 5030/6 A 80	-
					100	6,000	12,000	10	44655100	PNL 5030/6 A 100	-
					180	6,000	12,000	10	44655180	PNL 5030/6 A 180	-
					280	6,000	12,000	10	44655280	PNL 5030/6 A 280	-
					360	6,000	12,000	10	44698508	PNL 5030/6 A 360	-
60	25	6	40	A	100	5,000	10,000	10	44656010	PNL 6025/6 A 100	-
					180	5,000	10,000	10	44656018	PNL 6025/6 A 180	-
					280	5,000	10,000	10	44656028	PNL 6025/6 A 280	-
	50	6	40	A	80	5,000	10,000	10	47802761	PNL 6050 A 80	-
					100	5,000	10,000	10	44666100	PNL 6050/6 A 100	-
					180	5,000	10,000	10	44666180	PNL 6050/6 A 180	-
					280	5,000	10,000	10	44666280	PNL 6050/6 A 280	-
					360	5,000	10,000	10	44698509	PNL 6050/6 A 360	-

Continued on next page



D [mm]	T [mm]	S _d [mm]	L [mm]	Abrasive	Grit size	Opt. RPM	Max. RPM		Item no.	Designation	Price/unit EUR
80	25	6	40	A	100	4,000	7,500	10	44658010	PNL 8025/6 A 100	-
					180	4,000	7,500	10	44658018	PNL 8025/6 A 180	-
					280	4,000	7,500	10	44658028	PNL 8025/6 A 280	-
	50	6	40	A	80	4,000	7,500	10	44698510	PNL 8050/6 A 80	-
					100	4,000	7,500	10	44658100	PNL 8050/6 A 100	-
					180	4,000	7,500	10	44658180	PNL 8050/6 A 180	-
					280	4,000	7,500	10	44658280	PNL 8050/6 A 280	-
					360	4,000	7,500	10	44698511	PNL 8050/6 A 360	-

Silicon carbide (SiC)

40	20	6	40	SiC	100	7,500	15,000	10	44640410	PNL 4020/6 SiC 100	-
					180	7,500	15,000	10	44640418	PNL 4020/6 SiC 180	-
					280	7,500	15,000	10	44640428	PNL 4020/6 SiC 280	-
50	30	6	40	SiC	100	6,000	12,000	10	44640510	PNL 5030/6 SiC 100	-
					180	6,000	12,000	10	44640518	PNL 5030/6 SiC 180	-
					280	6,000	12,000	10	44640528	PNL 5030/6 SiC 280	-
60	50	6	40	SiC	100	5,000	10,000	10	44640610	PNL 6050/6 SiC 100	-
					180	5,000	10,000	10	44640618	PNL 6050/6 SiC 180	-
					280	5,000	10,000	10	44640628	PNL 6050/6 SiC 280	-
80	50	6	40	SiC	100	4,000	7,500	10	44640810	PNL 8050/6 SiC 100	-
					180	4,000	7,500	10	44640818	PNL 8050/6 SiC 180	-
					280	4,000	7,500	10	44640828	PNL 8050/6 SiC 280	-

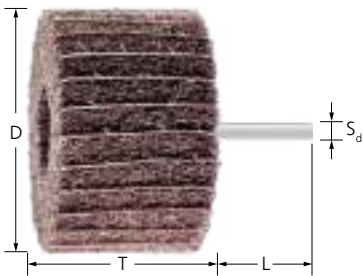

PNZ type

The non-woven abrasive material is arranged in multiple radial flaps, with abrasive cloth interlayers. This flap structure facilitates improved stock removal and achieves a coarser surface finish. Available in aluminium oxide A and silicon carbide (SiC).



Special features:

- Highly flexible, enabling optimal adjustment to the contour.
- Cool grinding and low thermal load on the workpiece.
- The open structure and high flexibility of the non-woven material prevents tool clogging.

D [mm]	T [mm]	S _d [mm]	L [mm]	Abrasive	Grit size	Opt. RPM	Max. RPM		Item no.	Designation	Price/unit EUR
Aluminium oxide A											
30	25	6	40	A	100	10,000	20,000	10	44653080	PNZ 3025/6 A 100	-
					180	10,000	20,000	10	44653088	PNZ 3025/6 A 180	-
40	20	6	40	A	80	7,500	15,000	10	44698512	PNZ 4020/6 A 80	-
					100	7,500	15,000	10	44654080	PNZ 4020/6 A 100	-
					180	7,500	15,000	10	44654088	PNZ 4020/6 A 180	-
50	30	6	40	A	80	6,000	12,000	10	44698513	PNZ 5030/6 A 80	-
					100	6,000	12,000	10	44655080	PNZ 5030/6 A 100	-
					180	6,000	12,000	10	44655088	PNZ 5030/6 A 180	-
60	25	6	40	A	100	5,000	10,000	10	44656030	PNZ 6025/6 A 100	-
					180	5,000	10,000	10	44656038	PNZ 6025/6 A 180	-
	50	6	40	A	80	5,000	10,000	10	44698514	PNZ 6050/6 A 80	-
					100	5,000	10,000	10	44656080	PNZ 6050/6 A 100	-
					180	5,000	10,000	10	44656088	PNZ 6050/6 A 180	-

Continued on next page



Non-woven tools

POLINOX mounted grinding wheels



D [mm]	T [mm]	S _d [mm]	L [mm]	Abrasive	Grit size	Opt. RPM	Max. RPM		Item no.	Designation	Price/unit EUR
80	25	6	40	A	100	4,000	7,500	10	44658030	PNZ 8025/6 A 100	-
					180	4,000	7,500	10	44658038	PNZ 8025/6 A 180	-
	50	6	40	A	80	4,000	7,500	10	44698515	PNZ 8050/6 A 80	-
					100	4,000	7,500	10	44658080	PNZ 8050/6 A 100	-
					180	4,000	7,500	10	44658088	PNZ 8050/6 A 180	-
					100	3,000	6,000	5	44690080	PNZ 10050/6 A 100	-
100	50	6	40	A	180	3,000	6,000	5	44690088	PNZ 10050/6 A 180	-

Silicon carbide (SiC)

80	50	6	40	SiC	100	4,000	7,500	10	44640806	PNZ 8050/6 SiC 100	-
					180	4,000	7,500	10	44640808	PNZ 8050/6 SiC 180	-

4



PNG type

Made of several very wavy arranged strips of non-woven abrasive material, wound around a core. The wavy structure of the non-woven abrasive material permits seamless brush matting of surfaces. Available in aluminium oxide A and silicon carbide (SiC).



Special features:

- Highly flexible, enabling optimal adjustment to the contour.
- Cool grinding and low thermal load on the workpiece.
- The open structure and high flexibility of the non-woven material prevents tool clogging.

D [mm]	T [mm]	S _d [mm]	L [mm]	Abrasive	Grit size	Opt. RPM	Max. RPM		Item no.	Designation	Price/unit EUR
Aluminium oxide A											
80	50	6	40	A	100	4,000	7,500	10	44646010	PNG 8050/6 A 100	-
					180	4,000	7,500	10	44646018	PNG 8050/6 A 180	-
					280	4,000	7,500	10	44646028	PNG 8050/6 A 280	-
100	50	6	40	A	100	3,000	6,000	5	44669100	PNG 10050/6 A 100	-
					180	3,000	6,000	5	44669180	PNG 10050/6 A 180	-
					280	3,000	6,000	5	44669280	PNG 10050/6 A 280	-
Silicon carbide (SiC)											
100	50	6	40	SiC	100	3,000	6,000	5	44640910	PNG 10050/6 SiC 100	-
					180	3,000	6,000	5	44640918	PNG 10050/6 SiC 180	-
					280	3,000	6,000	5	44640922	PNG 10050/6 SiC 280	-
80	50	6	40	SiC	100	4,000	7,500	10	44640851	PNG 8050/6 SiC 100	-
					180	4,000	7,500	10	44640858	PNG 8050/6 SiC 180	-
					280	4,000	7,500	10	44640862	PNG 8050/6 SiC 280	-



PNR type

The non-woven abrasive material is arranged in multiple (axial) disc layers. Since the individual non-woven discs are not interconnected, the abrasive surface adapts easily to different workpiece contours, e.g. when working on profiles or pipes. Available in aluminium oxide A.



Special features:

- Highly flexible, enabling optimal adjustment to the contour.
- Cool grinding and low thermal load on the workpiece.
- The open structure and high flexibility of the non-woven material prevents tool clogging.

D [mm]	T [mm]	S _d [mm]	L [mm]	Abrasive	Grit size	Opt. RPM	Max. RPM		Item no.	Designation	Price/unit EUR
Shank diameter of 2.35 mm											
25	15	2.35	40	A	100	7,600	12,300	10	44650131	PNR 2515/2,35 A 100	-
					180	7,600	12,300	10	44650132	PNR 2515/2,35 A 180	-
					280	7,600	12,300	10	44650133	PNR 2515/2,35 A 280	-
Shank diameter 3 mm											
25	15	3	40	A	100	7,600	12,300	10	44650231	PNR 2515/3 A 100	-
					180	7,600	12,300	10	44650232	PNR 2515/3 A 180	-
					280	7,600	12,300	10	44650233	PNR 2515/3 A 280	-
30	20	3	40	A	100	6,500	10,200	10	44650331	PNR 3020/3 A 100	-
					180	6,500	10,200	10	44650332	PNR 3020/3 A 180	-
					280	6,500	10,200	10	44650333	PNR 3020/3 A 280	-
Shank diameter 6 mm											
60	50	6	40	A	100	5,000	10,000	10	44656100	PNR 6050/6 A 100	-
					180	5,000	10,000	10	44656180	PNR 6050/6 A 180	-
					280	5,000	10,000	10	44656280	PNR 6050/6 A 280	-
80	50	6	40	A	100	4,000	7,500	10	44668100	PNR 8050/6 A 100	-
					180	4,000	7,500	10	44668180	PNR 8050/6 A 180	-
					280	4,000	7,500	10	44668280	PNR 8050/6 A 280	-



Non-woven tools

POLINOX cross buffs

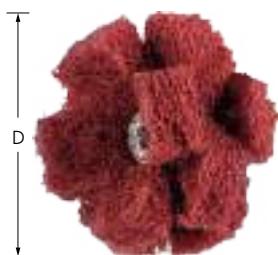

PNST type

Suitable for cleaning, deburring and fine grinding of inner surfaces and contours. Particularly suitable for hard-to-reach places such as drilled holes and indentations. Available in aluminium oxide A.



Special features:

- Highly flexible, enabling optimal adjustment to the contour. Cool grinding and low thermal load on the workpiece.
- The open structure and high flexibility of the non-woven material prevents tool clogging.
- Please order compatible arbor separately.

D [mm]	Abrasive	Grit size	Number of layers	Opt. RPM	Max. RPM		Item no.	Designation	Price/unit EUR
19	A	100	2	15,000	25,100	20	44698192	PNST 19-2 A 100	-
		280	2	15,000	25,100	20	44698193	PNST 19-2 A 280	-
25	A	80	2	10,000	19,100	20	44698254	PNST 25-2 A 80	-
		100	2	10,000	19,100	20	44698252	PNST 25-2 A 100	-
		280	2	10,000	19,100	20	44698253	PNST 25-2 A 280	-
38	A	80	3	7,500	12,600	20	44698384	PNST 38-3 A 80	-
		100	3	7,500	12,600	20	44698382	PNST 38-3 A 100	-
		280	3	7,500	12,600	20	44698383	PNST 38-3 A 280	-
50	A	80	2	5,500	9,500	20	44698504	PNST 50-2 A 80	-
		100	2	5,500	9,500	20	44698502	PNST 50-2 A 100	-
		280	2	5,500	9,500	20	44698503	PNST 50-2 A 280	-

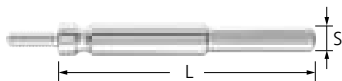

Arbor BO PNST

Arbor for POLINOX cross buffs. Both arbors are of different lengths, thus allowing holes or cut-outs of different depths to be reached.

Special features:

- High economic efficiency as tool can be changed quickly.

S [mm]	L [mm]	Thread [mm]	Clamping length [mm]		Item no.	Designation	Price/unit EUR
6	75	8-32 UNC	30	1	42700675	BO PNST 6-75	-
	125	8-32 UNC	30	1	42700685	BO PNST 6-125	-

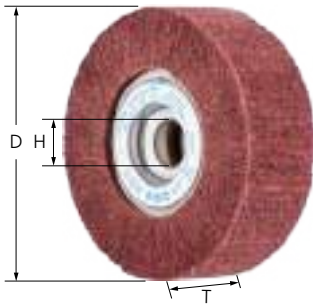

PNL type

The non-woven abrasive material with aluminium oxide A as the abrasive is arranged in multiple radial flaps. A long tool life is achieved through the dense packing of the flaps. This tool is mainly used for work on large surfaces.



Special features:

- Highly flexible, enabling optimal adjustment to the contour. Cool grinding and low thermal load on the workpiece.
- The open structure and high flexibility of the non-woven material prevents tool clogging.
- Please order compatible arbor separately.

D [mm]	T [mm]	H [mm]	Abrasive	Grit size	Opt. RPM	Max. RPM	Suitable arbors		Item no.	Designation	Price/unit EUR
150	50	25.4	A	100	2,000	4,000	FR/VR 12/25.4	1	44644111	PNL 15050/25,4 A 100	-
				180	2,000	4,000	FR/VR 12/25.4	1	44644119	PNL 15050/25,4 A 180	-
				280	2,000	4,000	FR/VR 12/25.4	1	44644129	PNL 15050/25,4 A 280	-
200	50	44	A	100	1,500	3,000	FR/VR 12/44.0	1	44644211	PNL 20050/44 A 100	-
				180	1,500	3,000	FR/VR 12/44.0	1	44644219	PNL 20050/44 A 180	-
				280	1,500	3,000	FR/VR 12/44.0	1	44644229	PNL 20050/44 A 280	-

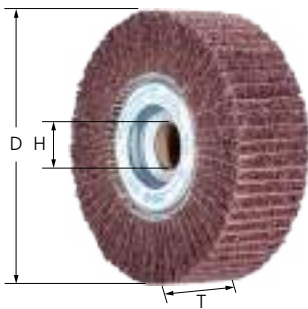

PNZ type

Grinding wheels with non-woven abrasive material with aluminium oxide A arranged in multiple radial flaps and with abrasive cloth between the flaps. This facilitates improved stock removal and achieves a coarser surface finish. The grinding wheels are mainly used for work on large surfaces.

Special features:

- Highly flexible, enabling optimal adjustment to the contour. Cool grinding and low thermal load on the workpiece.
- The open structure and high flexibility of the non-woven material prevents tool clogging.
- Please order compatible arbor separately.

D [mm]	T [mm]	H [mm]	Abrasive	Grit size	Opt. RPM	Max. RPM	Suitable arbors		Item no.	Designation	Price/unit EUR
150	50	25.4	A	100	2,000	4,000	FR/VR 12/25.4	1	44645111	PNZ 15050/25,4 A 100	-
				180	2,000	4,000	FR/VR 12/25.4	1	44645119	PNZ 15050/25,4 A 180	-
200	50	44	A	100	1,500	3,000	FR/VR 12/44.0	1	44645211	PNZ 20050/44 A 100	-
				180	1,500	3,000	FR/VR 12/44.0	1	44645219	PNZ 20050/44 A 180	-



Non-woven tools

POLINOX unmounted grinding wheels

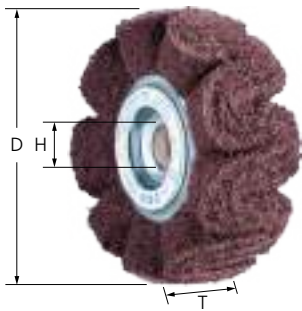

PNG type

Made of several very wavy arranged strips of non-woven abrasive material with aluminium oxide A as the abrasive, wound around a core. The wavy structure of the non-woven abrasive material permits seamless brush matting of surfaces.

Special features:

- Highly flexible, enabling optimal adjustment to the contour. Cool grinding and low thermal load on the workpiece.
- The open structure and high flexibility of the non-woven material prevents tool clogging.
- Please order compatible arbor separately.

D [mm]	T [mm]	H [mm]	Abrasive	Grit size	Opt. RPM	Max. RPM	Suitable arbors		Item no.	Designation	Price/unit EUR
150	50	25.4	A	100	2,000	4,000	FR/VR 12/25.4	1	44646111	PNG 15050/25,4 A 100	-
				180	2,000	4,000	FR/VR 12/25.4	1	44646119	PNG 15050/25,4 A 180	-
				280	2,000	4,000	FR/VR 12/25.4	1	44646129	PNG 15050/25,4 A 280	-
200	50	44	A	100	1,500	3,000	FR/VR 12/44.0	1	44646211	PNG 20050/44 A 100	-
				180	1,500	3,000	FR/VR 12/44.0	1	44646219	PNG 20050/44 A 180	-
				280	1,500	3,000	FR/VR 12/44.0	1	44646229	PNG 20050/44 A 280	-

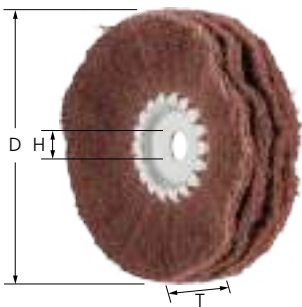

PNR type

Made of slightly wavy arranged strips of non-woven abrasive material with aluminium oxide A as the abrasive, wound around a metal core. Exceptional adaptation to contours thanks to the open arrangement and high flexibility. Enables seamless brush matting of surfaces, profiles and pipes.

Special features:

- Highly flexible, enabling optimal adjustment to the contour. Cool grinding and low thermal load on the workpiece.
- The open structure and high flexibility of the non-woven material prevents tool clogging.
- Please order compatible arbor separately.

D [mm]	T [mm]	H [mm]	Abrasive	Grit size	Opt. RPM	Max. RPM	Suitable arbors		Item no.	Designation	Price/unit EUR
100	35	10	A	180	2,500	5,500	BO 8/10	1	44647118	PNR 10035/10 A 180	-
				280	2,500	5,500	BO 8/10	1	44647128	PNR 10035/10 A 280	-
150	40	20	A	180	2,000	4,000	BO 12/20, BO MK 1/20	1	44647518	PNR 15040/20 A 180	-
				280	2,000	4,000	BO 12/20, BO MK 1/20	1	44647528	PNR 15040/20 A 280	-

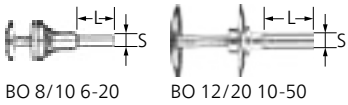

BO 8/10 6-20 BO 12/20 10-50



BO MK 1/20 10-50 FR/VR 12/25,4 100-165

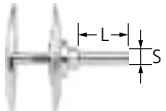

FR/VR 12/44 200-250

Arbor

Matching arbor for POLINOX unmounted grinding wheels.

Special features:

- High economic efficiency as tool can be changed quickly.

Suitable for hole diameter [mm]	S [mm]	L [mm]	Clamp- ing range [mm]		Item no.	Designation	Price/ unit EUR
10	8	30	6 – 20	1	42400008	BO 8/10 6-20	-
20	12	35	10 – 50	1	42400012	BO 12/20 10-50	-
	-	-	10 – 50	1	42400062	BO MK 1/20 10-50	-
25,4	12	40	25 – 50	1	44601225	FR/VR 12/25,4 100-165	-
44	12	40	25 – 50	1	44601244	FR/VR 12/44,0 200-250	-

Reducing flanges for POLINOX grinding wheels RF

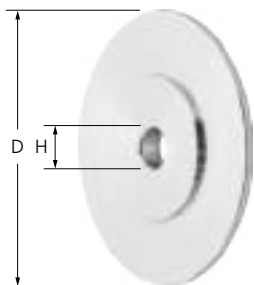

RF FR

For mounting unmounted flap wheels and POLINOX grinding wheels on drive spindles. The clamping flanges are designed to lie countersunk in the tool.

Special features:

- Can be adapted to an existing drive spindle by drilling.
- Can be used face-down very close to edges and in corners thanks to special clamping system.

Suitable for tool diameter [mm]	D [mm]	H [mm]	Max. H [mm]		Item no.	Designation	Price/unit EUR
150, 165	40	12	22.2	1	44771225	RF FR 150-165 Bo. 12-22,2	-
200, 250	83	12	40	1	44771244	RF FR 200-250 Bo. 12-40	-



Non-woven tools

Threaded POLINOX grinding wheels

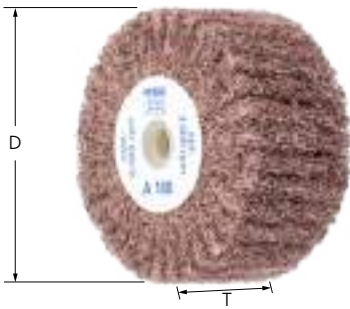

PNL type

The non-woven abrasive material with aluminium oxide A as the abrasive is arranged in multiple radial flaps. A long tool life is achieved through the dense packing of the flaps. For work on medium-sized surfaces.

Special features:

- Highly flexible, enabling optimal adjustment to the contour. Cool grinding and low thermal load on the workpiece.
- The open structure and high flexibility of the non-woven material prevents tool clogging.
- Can be mounted directly onto speed-adjustable angle grinders and fillet weld grinders without the need for additional clamping devices.

D [mm]	T [mm]	Thread	Abrasive	Grit size	Opt. RPM	Max. RPM		Item no.	Designation	Price/unit EUR
100	50	5/8-11	A	100	3,000	6,000	5	44642021	PNL 10050 5/8-11 A 100	-
				180	3,000	6,000	5	44642022	PNL 10050 5/8-11 A 180	-
				280	3,000	6,000	5	44642023	PNL 10050 5/8-11 A 280	-
	M14	A	100	3,000	6,000	5	44642001	PNL 10050 M14 A 100	-	
			180	3,000	6,000	5	44642002	PNL 10050 M14 A 180	-	
			280	3,000	6,000	5	44642003	PNL 10050 M14 A 280	-	

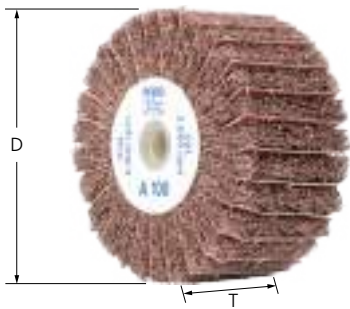

PNZ type

The non-woven abrasive material with aluminium oxide A as the abrasive is arranged in multiple radial flaps, with abrasive cloth interlayers. This facilitates improved stock removal and achieves a coarser surface finish. For work on medium-sized surfaces.



Special features:

- Highly flexible, enabling optimal adjustment to the contour. Cool grinding and low thermal load on the workpiece.
- The open structure and high flexibility of the non-woven material prevents tool clogging.
- Can be mounted directly onto speed-adjustable angle grinders and fillet weld grinders without the need for additional clamping devices.

D [mm]	T [mm]	Thread	Abrasive	Grit size	Opt. RPM	Max. RPM		Item no.	Designation	Price/unit EUR
100	50	5/8-11	A	100	3,000	6,000	5	44642121	PNZ 10050 5/8-11 A 100	-
				180	3,000	6,000	5	44642122	PNZ 10050 5/8-11 A 180	-
	M14	A	100	3,000	6,000	5	44642101	PNZ 10050 M14 A 100	-	
			180	3,000	6,000	5	44642102	PNZ 10050 M14 A 180	-	



PNG type

Made of several very wavy arranged strips of non-woven abrasive material with aluminium oxide A as the abrasive, wound around a core. The wavy structure of the non-woven abrasive material permits seamless brush matting of surfaces. For work on medium-sized surfaces.



Special features:

- Highly flexible, enabling optimal adjustment to the contour. Cool grinding and low thermal load on the workpiece.
- The open structure and high flexibility of the non-woven material prevents tool clogging.
- Can be mounted directly onto speed-adjustable angle grinders and fillet weld grinders without the need for additional clamping devices.

D [mm]	T [mm]	Thread	Abrasive	Grit size	Opt. RPM	Max. RPM		Item no.	Designation	Price/unit EUR
100	50	5/8-11	A	100	3,000	6,000	5	44642221	PNG 10050 5/8-11 A 100	-
				180	3,000	6,000	5	44642222	PNG 10050 5/8-11 A 180	-
				280	3,000	6,000	5	44642223	PNG 10050 5/8-11 A 280	-
		M14	A	100	3,000	6,000	5	44642201	PNG 10050 M14 A 100	-
				180	3,000	6,000	5	44642202	PNG 10050 M14 A 180	-
				280	3,000	6,000	5	44642203	PNG 10050 M14 A 280	-
125	50	5/8-11	A	100	2,300	3,800	2	44642521	PNG 12550 5/8-11 A 100	-
				180	2,300	3,800	2	44642522	PNG 12550 5/8-11 A 180	-
				280	2,300	3,800	2	44642523	PNG 12550 5/8-11 A 280	-
		M14	A	100	2,300	3,800	2	44642501	PNG 12550 M14 A 100	-
				180	2,300	3,800	2	44642502	PNG 12550 M14 A 180	-
				280	2,300	3,800	2	44642503	PNG 12550 M14 A 280	-



POLINOX grinding discs



PNL type

The non-woven abrasive flaps with aluminium oxide A as the abrasive are stuck to a glass-fabric backing pad, meaning the discs can be used face-down. A long tool life is achieved through the dense packing of the flaps.

Special features:

- Highly flexible, enabling optimal adjustment to the contour. Cool grinding and low thermal load on the workpiece.
- The open structure and high flexibility of the non-woven material prevents tool clogging.
- For work on large surfaces using speed-adjustable angle grinders.

D [mm]	T [mm]	H [mm]	Abrasive	Grit size	Opt. RPM	Max. RPM		Item no.	Designation	Price/unit EUR
115	20	22.23	A	100	2,500	5,300	5	44692258	PNL 115-22,23 A 100	-
				180	2,500	5,300	5	44692259	PNL 115-22,23 A 180	-
				280	2,500	5,300	5	44692260	PNL 115-22,23 A 280	-
125	20	22.23	A	100	2,300	3,800	5	44692261	PNL 125-22,23 A 100	-
				180	2,300	3,800	5	44692262	PNL 125-22,23 A 180	-
				280	2,300	3,800	5	44692263	PNL 125-22,23 A 280	-

Non-woven tools

POLINOX grinding discs



PNZ type

The non-woven and abrasive-cloth flaps with aluminium oxide A as the abrasive are stuck to a glass-fabric backing pad, meaning the discs can be used face-down on large surfaces. A long tool life is achieved through the dense packing of the flaps.

Special features:

- Highly flexible, enabling optimal adjustment to the contour. Cool grinding and low thermal load on the workpiece.
- The open structure and high flexibility of the non-woven material prevents tool clogging.
- For work on large surfaces using speed-adjustable angle grinders.

D [mm]	T [mm]	H [mm]	Abrasive	Grit size	Opt. RPM	Max. RPM		Item no.	Designation	Price/unit EUR
115	20	22.23	A	100	2,500	5,300	5	44692264	PNZ 115-22,23 A 100	-
				180	2,500	5,300	5	44692265	PNZ 115-22,23 A 180	-
125	20	22.23	A	100	2,300	3,800	5	44692266	PNZ 125-22,23 A 100	-
				180	2,300	3,800	5	44692267	PNZ 125-22,23 A 180	-



4 POLINOX grinding drums

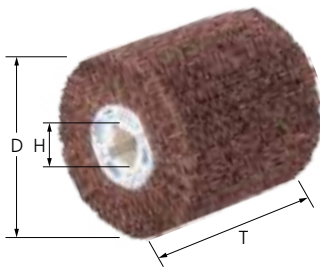

PNL-W type

For work on large surfaces. The non-woven abrasive material with aluminium oxide A as the abrasive is arranged in multiple radial flaps. A long tool life is achieved through the dense packing of the flaps.



Special features:

- Long tool life thanks to tightly packed flaps. Cool grinding and low thermal load on the workpiece.
- The open structure and high flexibility of the non-woven material prevents tool clogging.
- Suitable for all conventional keyway systems. The 19 mm hole diameter with four keyways fits all conventional drum grinders.

D [mm]	T [mm]	H [mm]	Abrasive	Grit size	Opt. RPM	Max. RPM		Item no.	Designation	Price/unit EUR
100	100	19	A	80	2,500	4,800	1	47801097	PNL-W 100100 A 80	-
				100	2,500	4,800	1	44641010	PNL-W 100100 A 100	-
				180	2,500	4,800	1	44641018	PNL-W 100100 A 180	-
				280	2,500	4,800	1	44641028	PNL-W 100100 A 280	-

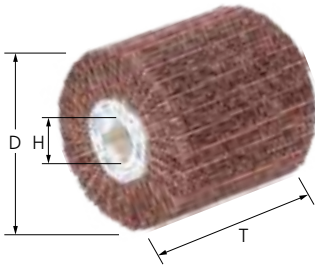

PNZ-W type

For work on large surfaces. The non-woven abrasive material with aluminium oxide A as the abrasive is arranged in multiple radial flaps. There is also abrasive cloth situated between the flaps. The flap arrangement results in a higher stock removal rate and produces a coarser surface finish.



Special features:

- Long tool life thanks to tightly packed flaps. Cool grinding and low thermal load on the workpiece.
- The open structure and high flexibility of the non-woven material prevents tool clogging.
- Suitable for all conventional keyway systems. The 19 mm hole diameter with four keyways fits all conventional drum grinders.

D [mm]	T [mm]	H [mm]	Abrasive	Grit size	Opt. RPM	Max. RPM		Item no.	Designation	Price/ unit EUR
100	100	19	A	60	2,500	4,800	1	44641106	PNZ-W 100100 A G/60	-
				80	2,500	4,800	1	44641108	PNZ-W 100100 A M/80	-
				120	2,500	4,800	1	44641112	PNZ-W 100100 A F/120	-

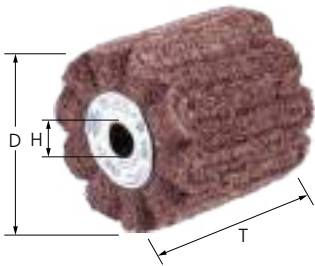

PNG-W type

For work on large surfaces. Made of several very wavy arranged strips of non-woven abrasive material with aluminium oxide A as the abrasive, wound around a core. The wavy structure of the non-woven abrasive material permits seamless brush matting of large surfaces.



Special features:

- Long tool life thanks to tight, wavy flaps. Cool grinding and low thermal load on the workpiece.
- The open structure and high flexibility of the non-woven material prevents tool clogging.
- Suitable for all conventional keyway systems. The 19 mm hole diameter with four keyways fits all conventional drum grinders.

D [mm]	T [mm]	H [mm]	Abrasive	Grit size	Opt. RPM	Max. RPM		Item no.	Designation	Price/ unit EUR
100	100	19	A	100	2,500	4,800	1	44641201	PNG-W 100100 A 100	-
				180	2,500	4,800	1	44641202	PNG-W 100100 A 180	-
				280	2,500	4,800	1	44641203	PNG-W 100100 A 280	-



Non-woven tools

POLINOX discs

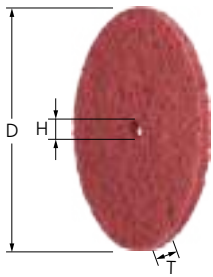

PVR type

POLINOX discs with aluminium oxide A as the abrasive are suited to flexible work on complicated tool contours, and are used in peripheral grinding applications. Clamp up to three discs behind one another to increase the usage width.



Special features:

- Highly flexible, enabling optimal adjustment to the contour, with very long tool life. Hard-to-reach areas can be accessed, such as deep slots and recesses.
- The open structure and high flexibility of the non-woven material prevents tool clogging.
- Please order the arbor for POLINOX discs separately.

D [mm]	T [mm]	H [mm]	Abrasive	Grit size	Max. RPM	Suitable arbors		Item no.	Designation	Price/unit EUR
50	10	6	A	100	12,250	BO 6/6 3-10	10	44693050	PVR 5008-6 A 100	-
				280	12,250	BO 6/6 3-10	10	44693051	PVR 5008-6 A 280	-
75	10	6	A	100	8,150	BO 6/6 3-10	10	44693075	PVR 7508-6 A 100	-
				280	8,150	BO 6/6 3-10	10	44693076	PVR 7508-6 A 280	-
100	10	13	A	100	6,150	PVR 6/13 1-25	10	44693101	PVR 10008-13 A 100	-
				280	6,150	PVR 6/13 1-25	10	44693102	PVR 10008-13 A 280	-
125	10	13	A	100	4,900	PVR 6/13 1-25	10	44693125	PVR 12508-13 A 100	-
				280	4,900	PVR 6/13 1-25	10	44693126	PVR 12508-13 A 280	-
150	10	13	A	100	4,100	PVR 6/13 1-25	10	44693151	PVR 15008-13 A 100	-
				280	4,100	PVR 6/13 1-25	10	44693152	PVR 15008-13 A 280	-

Arbor for POLINOX discs

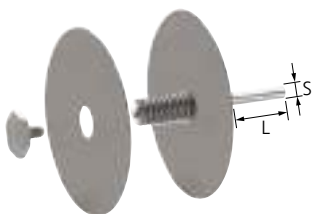

Arbor PVR

Arbor for POLINOX discs.

Special features:

- High economic efficiency as tool can be changed quickly.

- Use the supplied side discs with a diameter of 50 and 80 mm in order to vary the lateral flexibility.

Suitable for hole diameter [mm]	S [mm]	L [mm]	Clamping range [mm]		Item no.	Designation	Price/unit EUR
13	6	35	1 – 25	1	23600506	PVR 6/13 1-25	-



ADB masking tape

The self-adhesive masking tape is used to preserve the clear separation between different grinding patterns in adjacent areas. The masking tape protects surfaces which have already been worked on, or which are not supposed to be worked on.



Special features:

- ADB 20: High elasticity and tear strength. (Use only during finish machining with soft, flexible tools, e.g. non-woven tools.)
- ADB 50 INOX: Reusable and extremely high durability.
- High edge stability. To avoid its inadvertent removal, ensure that the masking tape is only loaded in the running direction of the tool.

L [m]	T [mm]		Item no.	Designation	Price/unit EUR
3	50	1	44250140	ADB 50 INOX	-
25	20	1	44250130	ADB 20	-

POLINOX marbling tools

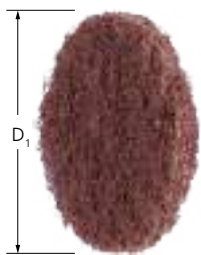

POLINOX discs for marbling tool holder MKRK

Special tool for marbling surfaces on almost any material.

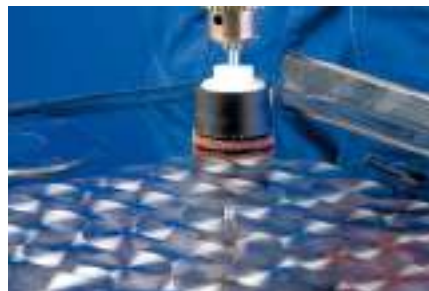

Special features:

- Highly flexible, enabling optimal adjustment to the contour. High economic efficiency due to high abrasive performance and long tool life.
- The open structure and high flexibility of the non-woven material prevents tool clogging.
- Please order matching marbling tool holder separately.

D ₁ [mm]	Abrasive	Grit size	Opt. RPM	Suitable arbors		Item no.	Designation	Price/unit EUR
40	A	100	600 – 1,400	MK 6/40/6	100	44637100	MKRR 40 A 100	-
		180	600 – 1,400	MK 6/40/6	100	44637180	MKRR 40 A 180	-
		280	600 – 1,400	MK 6/40/6	100	44637280	MKRR 40 A 280	-
50	A	100	600 – 1,400	MK 6/50/6	100	44638100	MKRR 50 A 100	-
		180	600 – 1,400	MK 6/50/6	100	44638180	MKRR 50 A 180	-
		280	600 – 1,400	MK 6/50/6	100	44638280	MKRR 50 A 280	-
60	A	100	600 – 1,400	MK 6/60/6	100	44639100	MKRR 60 A 100	-
		180	600 – 1,400	MK 6/60/6	100	44639180	MKRR 60 A 180	-
		280	600 – 1,400	MK 6/60/6	100	44639280	MKRR 60 A 280	-

Non-woven tools

POLINOX marbling tools

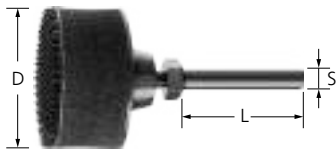

POLINOX marbling tool holders MK

POLINOX marbling tool holders for marbling discs. A highly elastic intermediate layer carries the Velcro fastening system.

Special features:

- Highly flexible, enabling optimal adjustment to the contour.

- High economic efficiency due to long tool life.

D [mm]	S [mm]	L [mm]	Max. RPM	Matching tool		Item no.	Designation	Price/unit EUR
40	6	40	4,700	MKRK 40	1	44604060	MK 6/40/6	-
50	6	40	3,800	MKRK 50	1	44605060	MK 6/50/6	-
60	6	40	3,200	MKRK 60	1	44606060	MK 6/60/6	-

POLIVLIES grinding discs



Flap discs PVL

Flap discs with abrasive flaps made of aluminium oxide A for general coarse to fine grinding applications in industry and professional trades.



Special features:

- High economic efficiency due to high abrasive performance and long tool life.
- Creates a consistently high surface quality over the entire tool life, as new sharp abrasive is steadily released.
- Highly flexible, enabling optimal adjustment to the contour.

D [mm]	T [mm]	H [mm]	Abrasive	Grit size	Opt. RPM	Max. RPM		Item no.	Designation	Price/unit EUR
Hole dia. 22.23 mm										
115	18	22.23	A	100 G	5,000 – 5,800	13,300	5	44694101	PVL 115 A 100 G	-
				180 M	5,000 – 5,800	13,300	5	44694102	PVL 115 A 180 M	-
				240 F	5,000 – 5,800	13,300	5	44694103	PVL 115 A 240 F	-
125	18	22.23	A	100 G	4,600 – 5,300	12,200	5	44694111	PVL 125 A 100 G	-
				180 M	4,600 – 5,300	12,200	5	44694112	PVL 125 A 180 M	-
				240 F	4,600 – 5,300	12,200	5	44694113	PVL 125 A 240 F	-
with X-LOCK holder										
115	18	22.23	A	100 G	5,000 – 5,800	13,300	5	44694201	PVL 115-X-LOCK A 100 G	-
				180 M	5,000 – 5,800	13,300	5	44694202	PVL 115-X-LOCK A 180 M	-
				240 F	5,000 – 5,800	13,300	5	44694203	PVL 115-X-LOCK A 240 F	-
125	18	22.23	A	100 G	4,600 – 5,300	12,200	5	44694211	PVL 125-X-LOCK A 100 G	-
				180 M	4,600 – 5,300	12,200	5	44694212	PVL 125-X-LOCK A 180 M	-
				240 F	4,600 – 5,300	12,200	5	44694213	PVL 125-X-LOCK A 240 F	-



Flap discs PVZ

Flap discs with abrasive flaps made of ceramic oxide grain CO-COOL and aluminium oxide A. Consistently high performance and aggressive grinding due to self-sharpening ceramic oxide grain. Active grinding additives improve the stock removal rate, prevent clogging and result in cooler grinding.



Special features:

- High economic efficiency due to high abrasive performance and long tool life.
- Creates a consistently high surface quality over the entire tool life, as new sharp abrasive is steadily released.
- Highly flexible, enabling optimal adjustment to the contour.

D [mm]	T [mm]	H [mm]	Abrasive/grit size	Opt. RPM	Max. RPM		Item no.	Designation	Price/unit EUR
115	18	22.23	CO-COOL 60 / A 100 G	5,000 – 5,800	13,300	5	44695101	PVZ 115 CO-COOL 60 / A 100 G	-
			CO-COOL 80 / A 180 M	5,000 – 5,800	13,300	5	44695102	PVZ 115 CO-COOL 80 / A 180 M	-
			CO-COOL 120 / A 240 F	5,000 – 5,800	13,300	5	44695103	PVZ 115 CO-COOL 120 / A 240 F	-
125	18	22.23	CO-COOL 60 / A 100 G	4,600 – 5,300	12,200	5	44695111	PVZ 125 CO-COOL 60 / A 100 G	-
			CO-COOL 80 / A 180 M	4,600 – 5,300	12,200	5	44695112	PVZ 125 CO-COOL 80 / A 180 M	-
			CO-COOL 120 / A 240 F	4,600 – 5,300	12,200	5	44695113	PVZ 125 CO-COOL 120 / A 240 F	-



Self-adhesive discs PVKR

These self-adhesive discs are suited to grinding larger surfaces. The flexible system, comprising a self-adhesive disc and holder, can also be used on contours. The pre-punched holes mean that they can be ideally centred on and used with various backing pads.



Special features:

- High economic efficiency due to high abrasive performance and long tool life. Highly flexible, enabling optimal adjustment to the contour.
- Creates a consistently high surface quality over the entire tool life, as new sharp abrasive is steadily released.
- Please order POLIVLIES self-adhesive disc holders separately. Break out the pre-punched centring hole if required.

D ₁ [mm]	Abrasive	Grit size	Opt. RPM	Max. RPM	Suitable arbors		Item no.	Designation	Price/unit EUR
115	A	100 G	3,300	5,300	PVKRH 115	10	42871306	PVKR 115 A 100 G	-
		180 M	3,300	5,300	PVKRH 115	10	42871310	PVKR 115 A 180 M	-
		240 F	3,300	5,300	PVKRH 115	10	42871318	PVKR 115 A 240 F	-
125	A	100 G	3,000	4,850	PVKRH 125	10	42871406	PVKR 125 A 100 G	-
		180 M	3,000	4,850	PVKRH 125	10	42871410	PVKR 125 A 180 M	-
		240 F	3,000	4,850	PVKRH 125	10	42871418	PVKR 125 A 240 F	-
180	A	100 G	2,200	3,500	PVKRH 180	10	42871606	PVKR 180 A 100 G	-
		180 M	2,200	3,500	PVKRH 180	10	42871610	PVKR 180 A 180 M	-
		240 F	2,200	3,500	PVKRH 180	10	42871618	PVKR 180 A 240 F	-



Non-woven tools

Self-adhesive disc holders PVKRH



Self-adhesive disc holders PVKRH

Holders for POLIVLIES self-adhesive discs.

Special features:

- High economic efficiency as tool can be changed quickly.
- Enables surface finishing without visible transitions.
- PVKRH-22 (with centring pin): enables faster central clamping.

D [mm]	Thread	Max. RPM		Item no.	Designation	Price/unit EUR
Without centring pin						
115	M14	5,300	1	42711154	PVKRH 115 M14	-
125	M14	4,850	1	42711254	PVKRH 125 M14	-
180	M14	3,500	1	42711784	PVKRH 180 M14	-
With centring pin						
115	M14	5,300	1	42712115	PVKRH 115-22 M14	-
125	M14	4,850	1	42712125	PVKRH 125-22 M14	-
180	M14	3,500	1	42712178	PVKRH 180-22 M14	-

4

POLICLEAN tools

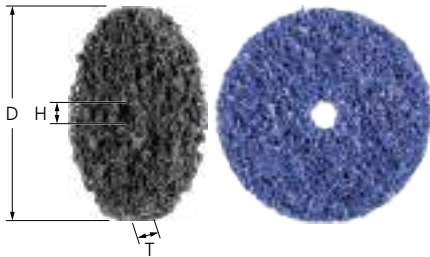

POLICLEAN wheels PCLS, POLICLEAN wheels PCLS PLUS

POLICLEAN is a coarsely structured, abrasive, non-woven cleaning fabric made from a special combination of synthetic fibres, resin and abrasive grain. For coarse cleaning work, such as removing paint, scale, heat discolouration, rust and adhesive residue in peripheral grinding.



Special features:

- High flexibility and open structure mean optimal adjustment to contours and no clogging of the tool itself.
- Standard version (black): for finer surface finishes, more flexible. PLUS version (blue): considerably higher stock removal rate and a very good tool life, very aggressive.
- Please order compatible arbor separately.

D [mm]	T [mm]	H [mm]	Opt. RPM	Max. RPM	Suitable arbors		Item no.	Designation	Price/unit EUR
PCLS (black) type									
75	13	6	4,000 – 5,100	10,000	PCLB 6/6/13, PCLB 6/6/26, PCLB 6/6/39	6	44692075	PCLS 7513/6	-
100	13	13	3,000 – 3,800	7,500	PCLB 6/13/13, PCLB 6/13/26, PCLB 8/13/13, PCLB 8/13/26	4	44692100	PCLS 10013/13	-
150	13	13	2,000 – 2,500	5,100	PCLB 6/13/13, PCLB 6/13/26, PCLB 8/13/13, PCLB 8/13/26	4	44692150	PCLS 15013/13	-

Continued on next page

D [mm]	T [mm]	H [mm]	Opt. RPM	Max. RPM	Suitable arbors		Item no.	Designation	Price/unit EUR
PCLS PLUS (blue) type									
75	13	6	4,000 – 5,100	10,000	PCLB 6/6/13, PCLB 6/6/26, PCLB 6/6/39	6	44692076	PCLS PLUS 7513/6	-
100	13	13	3,000 – 3,800	7,500	PCLB 6/13/13, PCLB 6/13/26, PCLB 8/13/13, PCLB 8/13/26	4	44692101	PCLS PLUS 10013/13	-
150	13	13	2,000 – 2,500	5,100	PCLB 6/13/13, PCLB 6/13/26, PCLB 8/13/13, PCLB 8/13/26	4	44692151	PCLS PLUS 15013/13	-



POLICLEAN arbors PCLB

Arbor for POLICLEAN wheels. The different variants provide space for one, two or three discs.

Special features:

- High economic efficiency as tool can be changed quickly. When replacing the discs, leave the arbor clamped in the tool drive.

Suitable for hole diameter [mm]	S [mm]	L [mm]	Matching tool	Version		Item no.	Designation	Price/unit EUR
6	6	40	PCLS 7513/6	Packaging, 1x	1	42706613	PCLB 6/6/13	-
				Packaging, 2x	1	42706626	PCLB 6/6/26	-
				Packaging, 3x	1	42706639	PCLB 6/6/39	-
13	6	40	PCLS 10013/13, PCLS 15013/13	Packaging, 1x	1	42706713	PCLB 6/13/13	-
				Packaging, 2x	1	42706726	PCLB 6/13/26	-
	8	40	PCLS 10013/13, PCLS 15013/13	Packaging, 1x	1	42706813	PCLB 8/13/13	-
				Packaging, 2x	1	42706826	PCLB 8/13/26	-

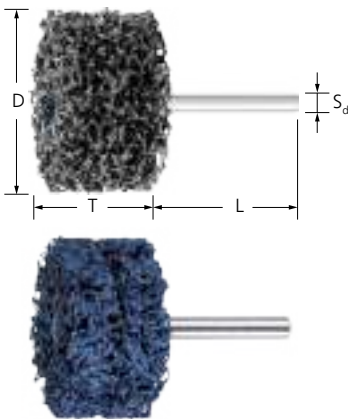

POLICLEAN mounted tools PCLZY, POLICLEAN mounted tools PCLZY PLUS

POLICLEAN is a coarsely structured, abrasive, non-woven cleaning fabric made from a special combination of synthetic fibres, resin and abrasive grain. For coarse cleaning work, such as removing paint, scale, heat discolouration, rust and adhesive residue in peripheral grinding.



Special features:

- High flexibility and open structure mean optimal adjustment to contours and no clogging of the tool itself.
- Standard version (black): for finer surface finishes, more flexible. PLUS version (blue): considerably higher stock removal rate and a very good tool life, very aggressive.

D [mm]	T [mm]	S _d [mm]	L [mm]	H [mm]	Opt. RPM	Max. RPM		Item no.	Designation	Price/unit EUR
PCLZY (black) type										
50	13	6	40	6	6,000 – 7,000	15,000	5	44692251	PCLZY 5013/6	-
	26	6	40	6	6,000 – 7,000	15,000	5	44692252	PCLZY 5026/6	-
75	13	6	40	6	4,000 – 5,100	10,000	5	44692271	PCLZY 7513/6	-
	26	6	40	6	4,000 – 5,100	10,000	5	44692272	PCLZY 7526/6	-

Continued on next page



D [mm]	T [mm]	S _d [mm]	L [mm]	H [mm]	Opt. RPM	Max. RPM		Item no.	Designation	Price/unit EUR
100	13	6	40	6	3,000 – 3,800	7,500	5	44692291	PCLZY 10013/6	-
PCLZY PLUS (blue) type										
50	13	6	40	6	6,000 – 7,000	15,000	5	44692253	PCLZY PLUS 5013/6	-
	26	6	40	6	6,000 – 7,000	15,000	5	44692254	PCLZY PLUS 5026/6	-
75	13	6	40	6	4,000 – 5,100	10,000	5	44692255	PCLZY PLUS 7513/6	-
	26	6	40	6	4,000 – 5,100	10,000	5	44692256	PCLZY PLUS 7526/6	-
100	13	6	40	6	3,000 – 3,800	7,500	5	44692257	PCLZY PLUS 10013/6	-

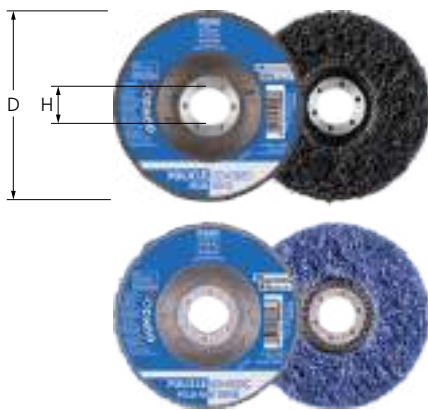

POLICLEAN discs PCLD, POLICLEAN discs PCLD PLUS

POLICLEAN is a coarsely structured, abrasive, non-woven cleaning fabric made from a special combination of synthetic fibres and abrasive grain. The non-woven cleaning material is glued onto a backer. For coarse cleaning work, e.g. removing paint, scale, heat discolouration, rust and adhesive residue.



Special features:

- High flexibility and open structure mean optimal adjustment to contours and no clogging of the tool itself.
- High stock removal rate and very long tool life.
- Standard version (black): for finer surface finishes, more flexible. PLUS version (blue): considerably higher stock removal rate and a very good tool life, very aggressive.

D [mm]	T [mm]	H [mm]	Opt. RPM	Max. RPM		Item no.	Designation	Price/unit EUR
PCLD (black) type								
115	13	22.23	5,000 – 7,000	10,000	5	44692715	PCLD 115-13	-
125	13	22.23	5,000 – 7,000	10,000	5	44692725	PCLD 125-13	-
PCLD PLUS (blue) type								
100	13	16	5,000 – 7,000	10,000	5	44692711	PCLD PLUS 100-13	-
115	13	22.23	5,000 – 7,000	10,000	5	44692716	PCLD PLUS 115-13	-
125	13	22.23	5,000 – 7,000	10,000	5	44692726	PCLD PLUS 125-13	-

Explanation of the code system according to EN 12413:

- D = Mounted point outer dia.
- T = Mounted point width
- S_d = Shank dia.
- L_0 = Unsupported shank length
- L_2 = Shank length
- L_3 = Clamping length of shank
- ① = collet

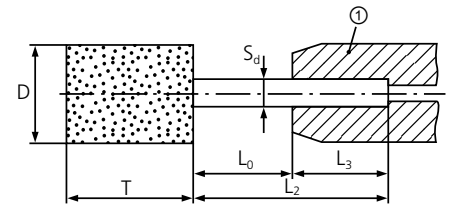

Safety notes

The maximum rotational speeds for the various shank lengths and shank diameters are defined in DIN 69170 based on EN 12413. These must be adhered to in order to avoid buckling of the shank during use. Regardless of the length of the shank, the clamping length (L_3) of the shank must be at least 10 mm.

Each packaging unit of PFERD fine grinding points contains the rotational speed specifications for the unsupported shank length (L_0) of that grinding point. Proper concentric accuracy and correct clamping of the tool drive must also be ensured.

Tables with the maximum permitted rotational speeds for the entire range of Poliflex fine grinding points are available on request. The maximum permitted rotational speed calculated according to EN 12413 is determined by the following factors:

- Shape and dimensions of the mounted point
- Diameter of the steel shank S_d
- Unsupported shank length L_0



Wear eye protection!



Wear hearing protection!



Wear gloves!



Wear a dust mask!



Follow the safety instructions!



The quick way to find the perfect tool

① Material group

Select the material to be machined.

② Application

Select the application.

③ Desired surface

Select your desired surface.

④ Tool bond

After determining the application (see column ②), the suitable bond is selected in the horizontal row.





				Bond ▶		Polyurethane bond			Elastomer bond				Resinoid bond	
				Abrasive (grain mixtures) ▶		CN			AR	ANCN	AW	AWCN	AN	
				④ Designation/bond ▶		PUR			GR	GHR	LR	LHR	TX	
				③ Surface ▼		W (soft)	MH (medium-hard)	STRUC						
				② Application ▼		Recommended cutting speed ▶			10–12 m/s	20–25 m/s	15–20 m/s	30–40 m/s	20–25 m/s	
① Material group ▼						10–12 m/s	10–15 m/s	5–10 m/s	10–12 m/s	20–25 m/s	15–20 m/s	30–40 m/s	20–25 m/s	
Steel, cast steel	Steels up to 1,200 N/mm ² (< 38 HRC)	Construction steels, carbon steels, tool steels, non-alloyed steels, case-hardened steels, tempering steels, cast steel	Surface	Matt	○	●			○					
				Shiny					●		○			
			Edge	Matt						○				●
				Shiny								●		○
	Hardened, heat-treated steels over 1,200 N/mm ² (> 38 HRC)	Tool steels, tempering steels, alloyed steels, alloyed cast steel	Surface	Matt	○	●			○					
				Shiny					○		●			
			Edge	Matt								○		●
				Shiny									○	●
Stainless steel (INOX)	Rust and acid-resistant steels	Surface	Matt	●	○									
			Shiny					●		○				
			Edge	Matt									●	
		Edge	Shiny							●		○		
			Universal	Structured	○	○	●							
		Non-ferrous metals	Soft non-ferrous metals, non-ferrous metals	Surface	Matt	●	○							
Shiny								○			●			
Edge	Matt									○			●	
	Shiny									○		●		
Hard non-ferrous metals	Surface		Matt										●	
			Shiny						○		●			
	Edge		Matt								○		●	
			Shiny								○		●	
High-temperature-resistant materials	Surface		Matt										●	
			Shiny						●		○			
	Edge		Matt								○		●	
			Shiny								○		●	

● = highly suitable ○ = suitable

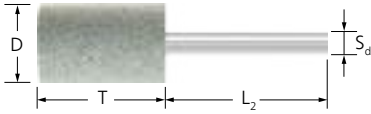

Poliflex fine grinding points PF ZY PUR

The PUR bond is manufactured with green silicon carbide (SiC). It is homogeneously interspersed with abrasive grain and very soft. Grinding point in cylindrical shape, for fine grinding of small surfaces.

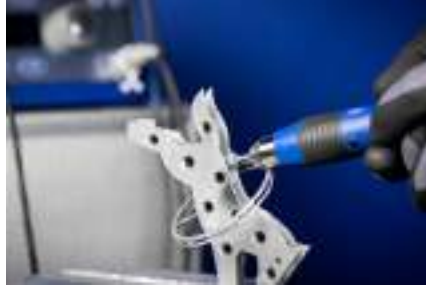

Special features:

- Highly flexible, enabling optimal adjustment to the contour.
- Cool and very gentle grinding thanks to open structure and elastic bond.
- Produces a fine, matt surface finish.

D [mm]	T [mm]	S _d [mm]	L ₂ [mm]	Abrasive	Grit size	Opt. RPM	Max. RPM		Item no.	Designation	Price/unit EUR
Shank diameter of 3 mm PUR-W											
8	12	3	30	SiC	80	24,000	35,800	10	41291008	PF ZY 0812/3 CN 80 PUR-W	-
					150	24,000	35,800	10	41291015	PF ZY 0812/3 CN 150 PUR-W	-
Shank diameter of 6 mm PUR-W											
10	25	6	40	SiC	80	19,000	28,600	10	41291208	PF ZY 1025/6 CN 80 PUR-W	-
					150	19,000	28,600	10	41291215	PF ZY 1025/6 CN 150 PUR-W	-
15	30	6	40	SiC	80	12,500	19,000	10	41291408	PF ZY 1530/6 CN 80 PUR-W	-
					150	12,500	19,000	10	41291415	PF ZY 1530/6 CN 150 PUR-W	-
20	30	6	40	SiC	80	9,500	14,300	10	41293108	PF ZY 2030/6 CN 80 PUR-W	-
					150	9,500	14,300	10	41293115	PF ZY 2030/6 CN 150 PUR-W	-
25	30	6	40	SiC	80	7,500	11,400	10	41293008	PF ZY 2530/6 CN 80 PUR-W	-
					150	7,500	11,400	10	41293015	PF ZY 2530/6 CN 150 PUR-W	-
Shank diameter of 3 mm PUR-MH											
8	12	3	30	SiC	150	24,000	35,800	10	41291115	PF ZY 0812/3 CN 150 PUR-MH	-
					220	24,000	35,800	10	41291122	PF ZY 0812/3 CN 220 PUR-MH	-
Shank diameter of 6 mm PUR-MH											
10	25	6	40	SiC	150	19,000	28,600	10	41291315	PF ZY 1025/6 CN 150 PUR-MH	-
					220	19,000	28,600	10	41291322	PF ZY 1025/6 CN 220 PUR-MH	-
15	30	6	40	SiC	80	12,500	19,000	10	41291508	PF ZY 1530/6 CN 80 PUR-MH	-
					150	12,500	19,000	10	41291515	PF ZY 1530/6 CN 150 PUR-MH	-
					220	12,500	19,000	10	41291522	PF ZY 1530/6 CN 220 PUR-MH	-
20	30	6	40	SiC	80	9,500	14,300	10	41293208	PF ZY 2030/6 CN 80 PUR-MH	-
					150	9,500	14,300	10	41293215	PF ZY 2030/6 CN 150 PUR-MH	-
32	32	6	40	SiC	80	6,000	8,900	5	41293408	PF ZY 3232/6 CN 80 PUR-MH	-
					150	6,000	8,900	5	41293415	PF ZY 3232/6 CN 150 PUR-MH	-





Poliflex discs PFD PUR for speed-adjustable angle grinders

The PUR bond is manufactured with green silicon carbide (SiC). It is homogeneously interspersed with abrasive grain and very soft. For fine face-down grinding on large surfaces.



Special features:

- Highly flexible, enabling optimal adjustment to the contour.
- Cool and very gentle grinding thanks to open structure and elastic bond.
- Produces a fine, matt surface finish.

D [mm]	T [mm]	H [mm]	Version	Abrasive	Grit size	Opt. RPM	Max. RPM		Item no.	Designation	Price/unit EUR
115	14	22.23	medium-hard	SiC	60	2,400	5,300	5	41130106	PFD 115-22 CN 60 PUR-MH	-
			soft	SiC	60	2,400	5,300	5	41130006	PFD 115-22 CN 60 PUR-W	-
			medium-hard	SiC	150	2,400	5,300	5	41130115	PFD 115-22 CN 150 PUR-MH	-
			soft	SiC	150	2,400	5,300	5	41130015	PFD 115-22 CN 150 PUR-W	-

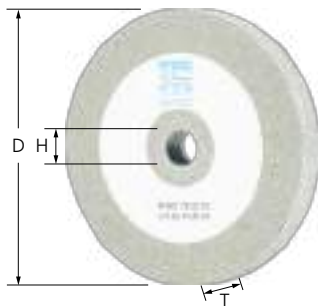

Poliflex fine grinding discs PF SC PUR

The PUR bond is manufactured with green silicon carbide (SiC). It is homogeneously interspersed with abrasive grain and very soft. For fine peripheral grinding on medium-sized to large surfaces.

Special features:

- Highly flexible, enabling optimal adjustment to the contour. Produces a fine, matt surface finish.
- Cool and very gentle grinding thanks to open structure and elastic bond.

■ Please order compatible arbor separately.

D [mm]	T [mm]	H [mm]	Abrasive	Grit size	Opt. RPM	Max. RPM	Suitable arbors		Item no.	Designation	Price/unit EUR
75	10	10	SiC	80	2,500	3,800	BO 8/10	5	41105408	PF SC 7510/10 CN 80 PUR-W	-
125	20	20	SiC	80	1,500	2,300	BO 12/20, BO MK 1/20	1	41110408	PF SC 12520/20 CN 80 PUR-W	-
150	25	20	SiC	80	1,200	1,900	BO 12/20, BO MK 1/20	1	41112408	PF SC 15025/20 CN 80 PUR-W	-
				150	1,200	1,900	BO 12/20, BO MK 1/20	1	41112415	PF SC 15025/20 CN 150 PUR-W	-

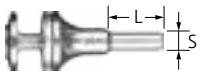

BO 8/10 6-20

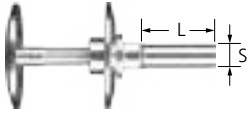

BO 12/20 10-50



BO MK 1/20 10-50

Arbor BO

Matching arbor for Poliflex fine grinding discs PF SC.

Special features:

- High economic efficiency as tool can be changed quickly.

Suitable for hole diameter [mm]	S [mm]	L [mm]	Clamping range [mm]		Item no.	Designation	Price/unit EUR
10	8	30	6 – 20	1	42400008	BO 8/10 6-20	-
20	12	35	10 – 50	1	42400012	BO 12/20 10-50	-
	-	-	10 – 50	1	42400062	BO MK 1/20 10-50	-



Poliflex blocks PUR

The PUR bond is manufactured with green silicon carbide (SiC). It is homogeneously interspersed with abrasive grain and very soft. The rhomboidal shape enables work to be effortlessly performed on hard-to-reach places such as corners.

Special features:

- Cool and very gentle grinding thanks to open structure and elastic bond.
- Produces a fine, matt surface finish.

- With a diamond cut-off wheel, the size can be adapted to the respective application as required.

L [mm]	B [mm]	H [mm]	Abrasive	Grit size		Item no.	Designation	Price/unit EUR
115	60	30	SiC	60	5	41020060	PFB 1156030 CU 60 PUR	-
				120	5	41020120	PFB 1156030 CU 120 PUR	-
				240	5	41020240	PFB 1156030 CU 240 PUR	-

Poliflex block set PSO PUR

Set of different Poliflex blocks PUR. The PUR bond is manufactured with green silicon carbide (SiC). It is homogeneously interspersed with abrasive grain and very soft.

Contents:

Nine pieces, three each of the following Poliflex blocks: grit size 60 (coarse), 120 (medium) and 240 (fine).

Special features:

- Cool and very gentle grinding thanks to open structure and elastic bond.
- Produces a fine, matt surface finish.
- Promotional display box.



L [mm]	B [mm]	H [mm]		Item no.	Designation	Price/unit EUR
285	150	60	1	41090002	Set PSO 11560	-





Poliflex marbling tool holders PFZY PUR

The PUR bond is manufactured with green silicon carbide (SiC). It is homogeneously interspersed with abrasive grain and very soft. Tools with female thread M8 for marbling surfaces.

Special features:

- Produces a fine, matt surface finish.
- Cool and very gentle grinding thanks to open structure and elastic bond.
- Please order compatible arbor separately.

D [mm]	T [mm]	H [mm]	Abrasive	Grit size	Max. RPM	Suitable arbors		Item no.	Designation	Price/unit EUR
50	40	M8	SiC	30	5,700	BO 6/8	5	41289403	PF ZY 5040 M8 CN 30 PUR	-
				80	5,700	BO 6/8	5	41289408	PF ZY 5040 M8 CN 80 PUR	-

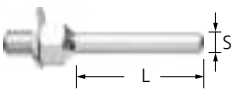

Arbor BO

Matching arbor for Poliflex marbling tool holders PFZY.

Special features:

- High economic efficiency as tool can be changed quickly.

S [mm]	L [mm]	Thread [mm]		Item no.	Designation	Price/unit EUR
6	40	M8	1	23600608	BO 6/8	-

4



PU-STRUC bond

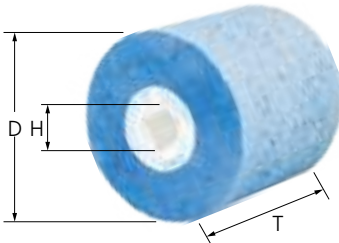

Poliflex texturing rollers PF W PU-STRUC

Structuring tools made of grey silicon carbide, homogeneously interspersed with a high proportion of abrasive grain. Ideal for work on components made of stainless steel (INOX). For structuring large surfaces.



Special features:

- Highly flexible, enabling optimal adjustment to the contour.
- Cool and gentle grinding thanks to open structure and elastic bond.
- Quick and effective retouching of imperfections and transitions to directional textures.

D [mm]	T [mm]	H [mm]	Abrasive	Opt. RPM	Max. RPM		Item no.	Designation	Price/unit EUR
100	100	19	SiC	1,000 – 1,900	2,800	1	41030016	PF W 100100/19 CU 16 PU-STRUC	-

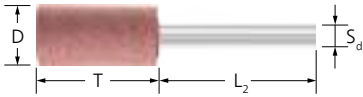

Poliflex fine grinding points PF ZY GR

This bond is a soft elastomer-based bond with pink aluminium oxide. Suitable for use on surfaces. Grinding point in cylindrical shape, for fine grinding of small surfaces.

Special features:

- Soft grinding thanks to soft, elastic bond.

- Produces a fine, shiny surface finish.

D [mm]	T [mm]	S _d [mm]	L ₂ [mm]	Abrasive	Grit size	Opt. RPM	Max. RPM		Item no.	Designation	Price/ unit EUR
Shank diameter 3 mm											
4	8	3	30	A	120	47,500	71,600	10	41200112	PF ZY 0408/3 AR 120 GR	-
6	10	3	30	A	120	32,000	47,700	10	41200512	PF ZY 0610/3 AR 120 GR	-
8	8	3	30	A	120	24,000	35,800	10	41201112	PF ZY 0808/3 AR 120 GR	-
					220	24,000	35,800	10	41201120	PF ZY 0808/3 AR 220 GR	-
	12	3	30	A	120	24,000	35,800	10	41204112	PF ZY 0812/3 AR 120 GR	-
					220	24,000	35,800	10	41204120	PF ZY 0812/3 AR 220 GR	-
10	6	3	30	A	120	19,000	28,600	10	41258112	PF ZY 1006/3 AR 120 GR	-
					220	19,000	28,600	10	41207112	PF ZY 1010/3 AR 120 GR	-
	10	3	30	A	120	19,000	28,600	10	41207120	PF ZY 1010/3 AR 220 GR	-
					220	19,000	28,600	10	41213112	PF ZY 1015/3 AR 120 GR	-
12	15	3	30	A	120	19,000	28,600	10	41213120	PF ZY 1015/3 AR 220 GR	-
					220	19,000	28,600	10	41264112	PF ZY 1208/3 AR 120 GR	-
12	8	3	30	A	120	16,000	23,800	10	41222112	PF ZY 1212/3 AR 120 GR	-
	12	3	30	A	120	16,000	23,800	10	41228112	PF ZY 1220/3 AR 120 GR	-
	20	3	30	A	120	16,000	23,800	10			-
Shank diameter 6 mm											
10	10	6	40	A	120	19,000	28,600	10	41210112	PF ZY 1010/6 AR 120 GR	-
					220	19,000	28,600	10	41216112	PF ZY 1015/6 AR 120 GR	-
					220	19,000	28,600	10	41216120	PF ZY 1015/6 AR 220 GR	-
	25	6	40	A	80	19,000	28,600	10	41219108	PF ZY 1025/6 AR 80 GR	-
					120	19,000	28,600	10	41219112	PF ZY 1025/6 AR 120 GR	-
220	19,000	28,600	10	41219120	PF ZY 1025/6 AR 220 GR	-					
12	8	6	40	A	120	16,000	23,800	10	41267112	PF ZY 1208/6 AR 120 GR	-
					220	16,000	23,800	10	41225112	PF ZY 1212/6 AR 120 GR	-
	20	6	40	A	120	16,000	23,800	10	41231112	PF ZY 1220/6 AR 120 GR	-
					220	16,000	23,800	10	41231120	PF ZY 1220/6 AR 220 GR	-
15	15	6	40	A	120	12,500	19,000	10	41234112	PF ZY 1515/6 AR 120 GR	-
					220	12,500	19,000	10	41237112	PF ZY 1525/6 AR 120 GR	-
					220	12,500	19,000	10	41237120	PF ZY 1525/6 AR 220 GR	-
	30	6	40	A	120	12,500	19,000	10	41240112	PF ZY 1530/6 AR 120 GR	-
					220	12,500	19,000	10	41240120	PF ZY 1530/6 AR 220 GR	-
					220	12,500	19,000	10	41273112	PF ZY 2012/6 AR 120 GR	-
20	20	6	40	A	120	9,500	14,300	10	41243112	PF ZY 2020/6 AR 120 GR	-
					220	9,500	14,300	10	41243120	PF ZY 2020/6 AR 220 GR	-
					80	9,500	14,300	10	41246108	PF ZY 2030/6 AR 80 GR	-
	30	6	40	A	120	9,500	14,300	10	41246112	PF ZY 2030/6 AR 120 GR	-
					220	9,500	14,300	10	41276112	PF ZY 2515/6 AR 120 GR	-
25	25	6	40	A	120	7,500	11,400	10	41249112	PF ZY 2525/6 AR 120 GR	-
					220	7,500	11,400	10	41249120	PF ZY 2525/6 AR 220 GR	-
					120	6,500	9,500	5	41279112	PF ZY 3020/6 AR 120 GR	-
30	30	6	40	A	120	6,500	9,500	5	41252112	PF ZY 3030/6 AR 120 GR	-
Shank diameter 8 mm											
40	25	8	40	A	120	4,500	9,500	5	41282112	PF ZY 4025/8 AR 120 GR	-



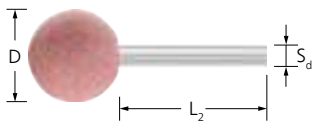

Poliflex fine grinding points PF KU GR

This bond is a soft elastomer-based bond with pink aluminium oxide. Suitable for use on surfaces. Grinding point in ball shape for fine grinding inner radii, contours and transitions.

Special features:

- Soft grinding thanks to soft, elastic bond.
- Produces a fine, shiny surface finish.

D [mm]	S _d [mm]	L ₂ [mm]	Abrasive	Grit size	Opt. RPM	Max. RPM		Item no.	Designation	Price/unit EUR
Shank diameter 3 mm										
8	3	30	A	120	24,000	35,800	10	41401112	PF KU 08/3 AR 120 GR	-
10	3	30	A	120	19,000	28,600	10	41407112	PF KU 10/3 AR 120 GR	-
Shank diameter 6 mm										
12	6	40	A	120	16,000	23,800	10	41425112	PF KU 12/6 AR 120 GR	-
15	6	40	A	120	12,500	19,000	10	41434112	PF KU 15/6 AR 120 GR	-
20	6	40	A	120	9,500	14,300	10	41443112	PF KU 20/6 AR 120 GR	-
25	6	40	A	120	7,500	11,400	10	41449112	PF KU 25/6 AR 120 GR	-
30	6	40	A	120	6,500	9,500	5	41452112	PF KU 30/6 AR 120 GR	-

4

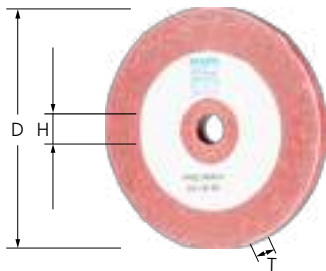

Poliflex fine grinding discs PF SC GR

A soft elastomer-based bond with pink aluminium oxide. Suitable for use on surfaces. Ideally suited to very fine grinding on all metallic materials, e.g. in tool and mould-making, in the dental sector and in the jewellery industry.

Special features:

- Soft grinding thanks to soft, elastic bond.
- Due to their construction, the small diameter variants are particularly suited to work on tight and hard-to-reach places.

D [mm]	T [mm]	H [mm]	Abrasive	Grit size	Opt. RPM	Max. RPM	Suitable arbors		Item no.	Designation	Price/unit EUR
25	3	2	A	120	7,500	11,400	BO 2,3/1-6, BO 3/1,6	100	41982401	PF SC 2503/2 AR 120 GR	-
30	6	6	A	120	6,300	9,500	BO 6/6 3-10	5	41100112	PF SC 3006/6 AR 120 GR	-
50	6	6	A	120	3,800	5,700	BO 6/6 3-10	5	41102112	PF SC 5006/6 AR 120 GR	-
80	6	10	A	120	2,400	3,500	BO 8/10	5	41106112	PF SC 8006/10 AR 120 GR	-
100	20	10	A	120	1,900	2,800	BO 8/10	1	41109112	PF SC 10020/10 AR 120 GR	-

GHR bond

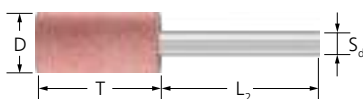

Poliflex fine grinding points PF ZY GHR

A soft yet sturdy bond with an abrasive mixture comprising aluminium oxide and silicon carbide (SiC), elastomer-based. Suitable for use on edges. Grinding point in cylindrical shape, for fine grinding of small surfaces.

Special features:

- Softer grinding with a longer tool life.
- Produces a fine, shiny surface finish.
- Poliflex fine grinding points with a grit size of 400 are manufactured from the abrasive AW white aluminium oxide.

D [mm]	T [mm]	S _d [mm]	L ₂ [mm]	Abrasive	Grit size	Opt. RPM	Max. RPM		Item no.	Designation	Price/unit EUR
Shank diameter 3 mm											
4	8	3	30	A	400	100,000	143,200	10	41200540	PF ZY 0408/3 AW 400 GHR	-
8	12	3	30	A/SiC	120	60,000	71,600	10	41204512	PF ZY 0812/3 ANCN 120 GHR	-
				A	400	60,000	71,600	10	41204540	PF ZY 0812/3 AW 400 GHR	-
10	10	3	30	A/SiC	120	45,000	57,200	10	41207512	PF ZY 1010/3 ANCN 120 GHR	-

Continued on next page

D [mm]	T [mm]	S _d [mm]	L ₂ [mm]	Abrasive	Grit size	Opt. RPM	Max. RPM		Item no.	Designation	Price/unit EUR
10	15	3	30	A/SiC	120	45,000	52,000	10	41213512	PF ZY 1015/3 ANCN 120 GHR	-
Shank diameter 6 mm											
10	25	6	40	A/SiC	120	45,000	57,200	10	41219512	PF ZY 1025/6 ANCN 120 GHR	-
				A	400	45,000	57,200	10	41219540	PF ZY 1025/6 AW 400 GHR	-
15	30	6	40	A/SiC	46	32,000	47,700	10	41240504	PF ZY 1530/6 ANCN 46 GHR	-
					80	32,000	47,700	10	41240508	PF ZY 1530/6 ANCN 80 GHR	-
20	30	6	40	A/SiC	46	24,000	28,600	10	41246504	PF ZY 2030/6 ANCN 46 GHR	-
25	25	6	40	A/SiC	46	19,000	22,900	10	41249504	PF ZY 2525/6 ANCN 46 GHR	-

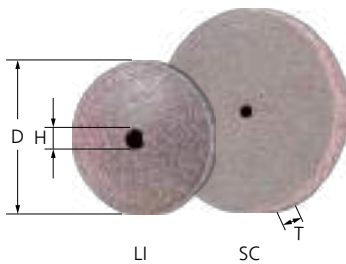

Poliflex fine grinding discs/lenses PF SC/LI GHR

A soft yet sturdy bond with an abrasive mixture comprising aluminium oxide and silicon carbide (SiC), elastomer-based. Suitable for use on edges. Ideally suited to very fine grinding on all metallic materials, e.g. in tool and mould-making, in the dental sector and in the jewellery industry.

Special features:

- Softer grinding with a longer tool life.
- Produces a fine, shiny surface finish.
- Due to their construction, the small diameter variants are particularly suited to work on tight and hard-to-reach places.

D [mm]	T [mm]	H [mm]	Abrasive	Grit size	Opt. RPM	Max. RPM	Suitable arbors		Item no.	Designation	Price/unit EUR
Disc shape											
25	3	2	SiC	220	7,500	11,400	BO 2,3/1,6- BO 3/1,6	100	41982510	PF SC 2503/2 CU 220 GHR	-
Lens shape											
16	4	2	SiC	220	12,000	17,900	BO 2,3/1,6- BO 3/1,6	100	41962020	PF LI 1604/2 CU 220 GHR	-
24	3	2	SiC	220	8,000	12,000	BO 2,3/1,6- BO 3/1,6	100	41963010	PF LI 2403/2 CU 220 GHR	-

Arbor BO

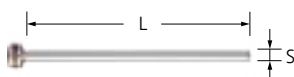

BO 2,3/1,6 1-5
BO 3/1,6 1-5

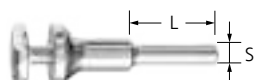

BO 6/6 3-10

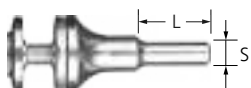

BO 8/10 6-20

Arbor BO

Matching arbor for POLIFLEX fine grinding discs PF SC.

Special features:

- High economic efficiency as tool can be changed quickly.

Suitable for hole diameter [mm]	S [mm]	L [mm]	Clamping range [mm]		Item no.	Designation	Price/unit EUR
1,6	2.34	43	1 – 5	10	42460023	BO 2,3/1,6 1-5	-
	3	43	1 – 5	10	42460030	BO 3/1,6 1-5	-
6	6	25	3 – 10	1	42400006	BO 6/6 3-10	-
10	8	30	6 – 20	1	42400008	BO 8/10 6-20	-

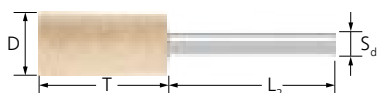

Poliflex fine grinding points PF ZY LR

A hard, sturdy bond with white aluminium oxide. Suitable for use on surfaces. Grinding point in cylindrical shape, for fine grinding of small surfaces.



Special features:

- Produces a fine, shiny surface finish.
- High economic efficiency due to high abrasive performance and long tool life.

D [mm]	T [mm]	S _d [mm]	L ₂ [mm]	Abrasive	Grit size	Opt. RPM	Max. RPM		Item no.	Designation	Price/unit EUR				
Shank diameter 3 mm															
4	8	3	30	A	120	95,000	143,200	10	41200212	PF ZY 0408/3 AW 120 LR	-				
					400	95,000	143,200	10	41200240	PF ZY 0408/3 AW 400 LR	-				
6	10	3	30	A	120	64,000	95,400	10	41200612	PF ZY 0610/3 AW 120 LR	-				
					8	8	3	30	A	120	47,500	71,600	10	41201212	PF ZY 0808/3 AW 120 LR
8	12	3	30	A	120	47,500	71,600	10	41204212	PF ZY 0812/3 AW 120 LR	-				
					220	47,500	71,600	10	41204220	PF ZY 0812/3 AW 220 LR	-				
					400	47,500	71,600	10	41204240	PF ZY 0812/3 AW 400 LR	-				
					10	10	3	30	A	120	38,000	57,200	10	41207212	PF ZY 1010/3 AW 120 LR
10	10	3	30	A	220	38,000	57,200	10	41207220	PF ZY 1010/3 AW 220 LR	-				
					15	3	30	A	120	38,000	57,200	10	41213212	PF ZY 1015/3 AW 120 LR	-
12	12	3	30	A	120	32,000	47,700	10	41222212	PF ZY 1212/3 AW 120 LR	-				
					20	3	30	A	120	32,000	47,700	10	41228212	PF ZY 1220/3 AW 120 LR	-
Shank diameter 6 mm															
10	10	6	40	A	120	38,000	57,200	10	41210212	PF ZY 1010/6 AW 120 LR	-				
					15	6	40	A	120	38,000	57,200	10	41216212	PF ZY 1015/6 AW 120 LR	-
					25	6	40	A	120	38,000	57,200	10	41219212	PF ZY 1025/6 AW 120 LR	-
					220	38,000	57,200	10	41219220	PF ZY 1025/6 AW 220 LR	-				
12	12	6	40	A	120	32,000	47,700	10	41225212	PF ZY 1212/6 AW 120 LR	-				
					20	6	40	A	120	32,000	47,700	10	41231212	PF ZY 1220/6 AW 120 LR	-
15	15	6	40	A	120	25,500	38,100	10	41234212	PF ZY 1515/6 AW 120 LR	-				
					25	6	40	A	120	25,500	38,100	10	41237212	PF ZY 1525/6 AW 120 LR	-
					30	6	40	A	120	25,500	38,100	10	41240212	PF ZY 1530/6 AW 120 LR	-
20	20	6	40	A	120	19,000	28,600	10	41243212	PF ZY 2020/6 AW 120 LR	-				
					30	6	40	A	120	19,000	28,600	10	41246212	PF ZY 2030/6 AW 120 LR	-
25	25	6	40	A	120	15,000	22,900	10	41249212	PF ZY 2525/6 AW 120 LR	-				
30	30	6	40	A	120	12,500	19,000	5	41252212	PF ZY 3030/6 AW 120 LR	-				

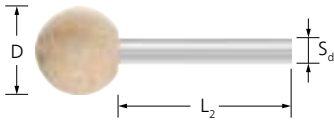

Poliflex fine grinding points PF KU LR

A hard, sturdy bond with white aluminium oxide. Suitable for use on surfaces. Grinding point in ball shape for fine grinding inner radii, contours and transitions.



Special features:

- Produces a fine, shiny surface finish.
- High economic efficiency due to high abrasive performance and long tool life.

D [mm]	S _d [mm]	L ₂ [mm]	Abrasive	Grit size	Opt. RPM	Max. RPM		Item no.	Designation	Price/unit EUR
Shank diameter 3 mm										
8	3	30	A	120	47,000	71,600	10	41401212	PF KU 08/3 AW 120 LR	-
10	3	30	A	120	38,000	57,200	10	41410212	PF KU 10/3 AW 120 LR	-
Shank diameter 6 mm										
15	6	40	A	120	29,500	38,100	10	41434212	PF KU 15/6 AW 120 LR	-
20	6	40	A	120	19,000	28,600	10	41443212	PF KU 20/6 AW 120 LR	-

LHR bond

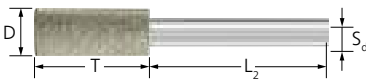

Poliflex fine grinding points PF ZY LHR

A hard, sturdy bond made of white aluminium oxide. Suitable for use on edges. Grinding point in cylindrical shape, for fine grinding of small surfaces.

Special features:

- Produces a fine, shiny surface finish.
- High economic efficiency due to high abrasive performance and long tool life.
- Poliflex fine grinding points LHR with a grit size of 60 are manufactured from an abrasive mixture of AWCN white aluminium oxide and green silicon carbide (SiC).

D [mm]	T [mm]	S _d [mm]	L ₂ [mm]	Abrasive	Grit size	Opt. RPM	Max. RPM		Item no.	Designation	Price/unit EUR
Shank diameter 3 mm											
8	12	3	30	A	120	47,000	76,700	10	41204312	PF ZY 0812/3 AW 120 LHR	-
Shank diameter 6 mm											
10	25	6	40	A	120	75,000	83,200	10	41219312	PF ZY 1025/6 AW 120 LHR	-
				A/SiC	60	75,000	83,200	10	41219306	PF ZY 1025/6 AWCN 60 LHR	-
20	20	6	40	A	120	38,000	47,700	10	41243312	PF ZY 2020/6 AW 120 LHR	-





Poliflex fine grinding points PF ZY TX

Very hard, sturdy bond with textile fabric inlays made of regular aluminium oxide. Suitable for use on edges. Grinding point in cylindrical shape, for fine grinding of small surfaces.

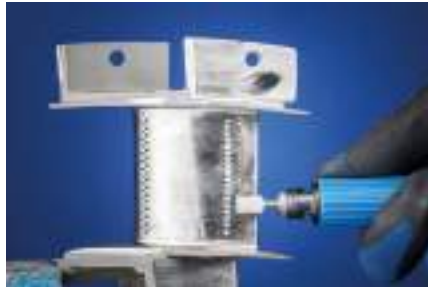

Special features:

- Produces a fine, matt surface finish.
- High economic efficiency due to high abrasive performance and long tool life.
- The dimensions of 19 x 2.5 mm are particularly suitable for cleaning seat mounting rails (tracks) in commercial aircraft.

D [mm]	T [mm]	S _d [mm]	L ₂ [mm]	Abrasive	Grit size	Opt. RPM	Max. RPM		Item no.	Designation	Price/unit EUR
Shank diameter 3 mm											
6	10	3	30	A	80	63,000	95,400	10	41200708	PF ZY 0610/3 AN 80 TX	-
					120	63,000	95,400	10	41200712	PF ZY 0610/3 AN 120 TX	-
8	12	3	30	A	80	47,500	71,600	10	41204608	PF ZY 0812/3 AN 80 TX	-
					120	47,500	71,600	10	41204612	PF ZY 0812/3 AN 120 TX	-
Shank diameter 6 mm											
10	25	6	40	A	80	38,000	57,200	10	41219608	PF ZY 1025/6 AN 80 TX	-
					120	38,000	57,200	10	41219612	PF ZY 1025/6 AN 120 TX	-
16	32	6	40	A	80	24,000	35,800	10	41241608	PF ZY 1632/6 AN 80 TX	-
					120	24,000	35,800	10	41241612	PF ZY 1632/6 AN 120 TX	-
19	2.5	6	40	A	80	20,000	30,100	10	47000886	PF ZY 192,5/6 AN 80 TX	-
20	32	6	40	A	80	19,000	28,600	10	41247608	PF ZY 2032/6 AN 80 TX	-
					120	19,000	28,600	10	41247612	PF ZY 2032/6 AN 120 TX	-
25	32	6	40	A	80	15,000	22,900	10	41250608	PF ZY 2532/6 AN 80 TX	-
					120	15,000	22,900	10	41250612	PF ZY 2532/6 AN 120 TX	-

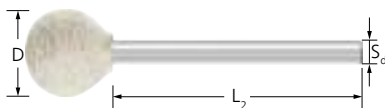

Poliflex fine grinding points PF KU TX

Very hard, sturdy bond with textile fabric inlays made of regular aluminium oxide. Suitable for use on edges. Grinding point in ball shape for fine grinding inner radii, contours and transitions.

Special features:

- Produces a fine, matt surface finish.

- High economic efficiency due to high abrasive performance and long tool life.

D [mm]	S _d [mm]	L ₂ [mm]	Abrasive	Grit size	Opt. RPM	Max. RPM		Item no.	Designation	Price/unit EUR
6	3	30	A	80	63,000	95,400	10	41400608	PF KU 06/3 AN 80 TX	-
				120	63,000	95,400	10	41400612	PF KU 06/3 AN 120 TX	-
8	3	30	A	120	47,500	71,600	10	41401612	PF KU 08/3 AN 120 TX	-
10	3	30	A	120	38,000	57,200	10	41407612	PF KU 10/3 AN 120 TX	-



Poliflex fine grinding points PF KE TX

Very hard, sturdy bond with textile fabric inlays made of regular aluminium oxide. Suitable for use on edges. Grinding point in conical shape for fine grinding inner radii, contours and transitions.



Special features:

- Produces a fine, matt surface finish.
- High economic efficiency due to high abrasive performance and long tool life.

D [mm]	T [mm]	S _d [mm]	L ₂ [mm]	Abrasive	Grit size	Opt. RPM	Max. RPM		Item no.	Designation	Price/unit EUR
10	25	6	40	A	80	38,000	57,200	10	41719608	PF KE 1025/6 AN 80 TX	-
					120	38,000	57,200	10	41719612	PF KE 1025/6 AN 120 TX	-
16	45	6	40	A	80	24,000	38,800	10	41738608	PF KE 1645/6 AN 80 TX	-
25	70	6	40	A	80	15,000	22,900	10	41750608	PF KE 2570/6 AN 80 TX	-



Poliflex fine grinding points PF SP TX

Very hard, sturdy bond with textile fabric inlays made of regular aluminium oxide. Grinding point in pointed tree shape for fine grinding inner radii, contours and transitions.



Special features:

- Produces a fine, matt surface finish.
- High economic efficiency due to high abrasive performance and long tool life.

D [mm]	T [mm]	S _d [mm]	L ₂ [mm]	Abrasive	Grit size	Opt. RPM	Max. RPM		Item no.	Designation	Price/unit EUR
Shank diameter 3 mm											
10	20	3	30	A	80	38,000	57,200	10	41310608	PF SP 1020/3 AN 80 TX	-
					120	38,000	57,200	10	41310612	PF SP 1020/3 AN 120 TX	-
Shank diameter 6 mm											
20	32	6	40	A	80	19,000	28,600	10	41320608	PF SP 2032/6 AN 80 TX	-
					120	19,000	28,600	10	41320612	PF SP 2032/6 AN 120 TX	-



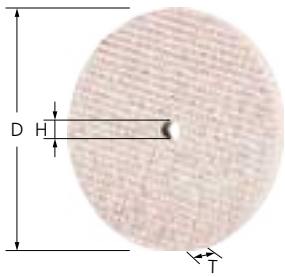

Poliflex fine grinding discs PF SC TX

Very hard, sturdy bond with textile fabric inlays made of regular aluminium oxide. For fine peripheral grinding on small surfaces.

Special features:

- Produces a fine, matt surface finish.
- High economic efficiency due to high abrasive performance and long tool life.
- Please order compatible arbor separately.

D [mm]	T [mm]	H [mm]	Abrasive	Grit size	Opt. RPM	Max. RPM	Suitable arbors		Item no.	Designation	Price/unit EUR
25	3	3	A	80	15,000	22,900	BO 6/3 1-6	20	41120308	PF SC 2503/3 A 80 TX	-
				120	15,000	22,900	BO 6/3 1-6	20	41120312	PF SC 2503/3 A 120 TX	-
40	3	3	A	80	9,500	14,300	BO 6/3 1-6	10	41121408	PF SC 4003/3 A 80 TX	-
				120	9,500	14,300	BO 6/3 1-6	10	41121412	PF SC 4003/3 A 120 TX	-
	6	6	A	120	9,500	14,300	BO 6/6 3-10	10	41121612	PF SC 4006/6 A 120 TX	-

4

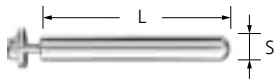

BO 6/3 1-6

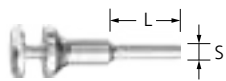

BO 6/6 3-10

Arbor BO

Matching arbor for Poliflex fine grinding discs PF SC.

Special features:

- High economic efficiency as tool can be changed quickly.

Suitable for hole diameter [mm]	S [mm]	L [mm]	Clamping range [mm]		Item no.	Designation	Price/unit EUR
3	6	40	1 – 6	1	42400003	BO 6/3 1-6	-
6	6	25	3 – 10	1	42400006	BO 6/6 3-10	-



Safety notes

■ For safety reasons, the maximum permitted rotational speed indicated must never be exceeded.



Wear gloves!



Wear eye protection!



Wear a dust mask!



Wear hearing protection!



Follow the safety instructions!



Felt points FK

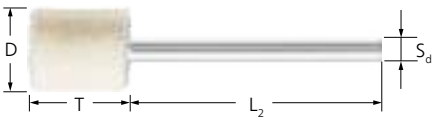

Shape ZYA

The cylindrical shape ZYA is mainly used peripherally for pre-polishing and high-gloss polishing. Can be profiled as desired, meaning they can also be used for tools with complex geometries. Precise retention of geometric shapes due to the hardness of these tools.

Special features:

- Use diamond polishing pastes and polishing paste bars. Please order separately.
- The variant with an end hole (ST-BO) is particularly suitable for face-down use.

- Felt points with metal inserts (MS) are used for increased stock removal when pre-polishing with diamond polishing pastes.

D [mm]	T [mm]	S _d [mm]	L ₂ [mm]	Version	Opt. RPM	Max. RPM		Item no.	Designation	Price/unit EUR
Shank diameter of 2.35 mm										
6	10	2.35	35	M (medium)	16,000 – 32,000	79,500	10	44100608	FK ZYA 0610/2,35 M	-
				H (hard)	16,000 – 32,000	79,500	10	44100612	FK ZYA 0610/2,35 H	-
8	10	2.35	35	M (medium)	12,000 – 24,000	59,500	10	44140808	FK ZYA 0810/2,35 M	-
				H (hard)	12,000 – 24,000	59,500	10	44140814	FK ZYA 0810/2,35 H	-
Shank diameter 3 mm										
4	12	3	37	M (medium)	23,000 – 47,000	119,000	10	44100412	FK ZYA 0412/3 M	-
6	10	3	35	M (medium)	16,000 – 32,000	79,500	10	44140610	FK ZYA 0610/3 M	-
				H (hard)	16,000 – 32,000	79,500	10	44100614	FK ZYA 0610/3 H	-
8	10	3	35	M (medium)	12,000 – 24,000	59,500	10	44140810	FK ZYA 0810/3 M	-
				H (hard)	12,000 – 24,000	59,500	10	44140816	FK ZYA 0810/3 H	-
10	12	3	34	M (medium)	10,000 – 20,000	47,500	10	44111009	FK ZYA 1012/3 M	-
				H (hard)	10,000 – 20,000	47,500	10	44111010	FK ZYA 1012/3 H	-
	15	3	32	M (medium)	10,000 – 20,000	47,500	10	44111013	FK ZYA 1015/3 M	-
				H (hard)	10,000 – 20,000	47,500	10	44161015	FK ZYA 1015/3 H	-
12	20	3	28	MS (metal insert)	10,000 – 20,000	47,500	10	44161014	FK ZYA 1015/3 MS	-
				M (medium)	7,950 – 15,900	39,500	10	44100038	FK ZYA 1220/3 M	-
12	20	3	28	H (hard)	7,950 – 15,900	39,500	10	44100040	FK ZYA 1220/3 H	-
Shank diameter of 3 mm – with end hole										
15	20	3	28	M (medium)	6,000 – 12,000	31,500	10	44100046	FK ZYA 1520/3 M ST-BO	-
				H (hard)	6,000 – 12,000	31,500	10	44100048	FK ZYA 1520/3 H ST-BO	-
Shank diameter 6 mm										
10	12	6	42	M (medium)	10,000 – 20,000	47,500	10	44111011	FK ZYA 1012/6 M	-
				H (hard)	10,000 – 20,000	47,500	10	44111012	FK ZYA 1012/6 H	-
10	15	6	40	M (medium)	10,000 – 20,000	47,500	10	44101671	FK ZYA 1015/6 M	-
				H (hard)	10,000 – 20,000	47,500	10	44161016	FK ZYA 1015/6 H	-
12	20	6	36	M (medium)	7,950 – 15,900	39,500	10	44100042	FK ZYA 1220/6 M	-
				H (hard)	7,950 – 15,900	39,500	10	44100044	FK ZYA 1220/6 H	-

Continued on next page

D [mm]	T [mm]	S _d [mm]	L ₂ [mm]	Version	Opt. RPM	Max. RPM		Item no.	Designation	Price/unit EUR
Shank diameter of 6 mm – with end hole										
15	20	6	38	M (medium)	6,000 – 12,000	31,500	10	44151520	FK ZYA 1520/6 M ST-BO	-
				H (hard)	6,000 – 12,000	31,500	10	44100050	FK ZYA 1520/6 H ST-BO	-
				MS (metal insert)	6,000 – 12,000	31,500	10	44161520	FK ZYA 1520/6 MS ST-BO	-
20	25	6	43	M (medium)	5,000 – 10,000	23,500	10	44101701	FK ZYA 2025/6 M ST-BO	-
				H (hard)	5,000 – 10,000	23,500	10	44100052	FK ZYA 2025/6 H ST-BO	-
				MS (metal insert)	5,000 – 10,000	23,500	10	44162025	FK ZYA 2025/6 MS ST-BO	-
25	30	6	40	M (medium)	4,000 – 8,000	19,000	10	44112536	FK ZYA 2530/6 M ST-BO	-
				H (hard)	4,000 – 8,000	19,000	10	44100054	FK ZYA 2530/6 H ST-BO	-
				MS (metal insert)	4,000 – 8,000	19,000	10	44162530	FK ZYA 2530/6 MS ST-BO	-



Shape SPK

The conical pointed shape SPK is mainly used for pre-polishing and high-gloss polishing of radii and contours.

Special features:

- Precise retention of geometric shapes due to the hardness of these tools.
- Can be profiled as desired, meaning they can also be used for tools with complex geometries.
- Use diamond polishing pastes and polishing paste bars. Please order separately.

D [mm]	T [mm]	S _d [mm]	L ₂ [mm]	Version	Opt. RPM	Max. RPM		Item no.	Designation	Price/unit EUR
Shank diameter of 2.35 mm										
6	10	2.35	37	M (medium)	16,000 – 32,000	79,500	10	44100110	FK SPK 0610/2,35 M	-
				H (hard)	16,000 – 32,000	79,500	10	44100112	FK SPK 0610/2,35 H	-
	18	2.35	37	M (medium)	16,000 – 32,000	79,500	10	44100116	FK SPK 0618/2,35 M	-
				H (hard)	16,000 – 32,000	79,500	10	44100120	FK SPK 0618/2,35 H	-
8	12	2.35	36	M (medium)	12,000 – 24,000	59,500	10	44100124	FK SPK 0812/2,35 M	-
				H (hard)	12,000 – 24,000	59,500	10	44100126	FK SPK 0812/2,35 H	-
Shank diameter 3 mm										
6	10	3	37	M (medium)	16,000 – 32,000	79,500	10	47901120	FK SPK 0610/3 M	-
				H (hard)	16,000 – 32,000	79,500	10	44100114	FK SPK 0610/3 H	-
	18	3	37	M (medium)	16,000 – 32,000	79,500	10	44100118	FK SPK 0618/3 M	-
				H (hard)	16,000 – 32,000	79,500	10	44100122	FK SPK 0618/3 H	-
8	12	3	36	M (medium)	12,000 – 24,000	59,500	10	44140812	FK SPK 0812/3 M	-
				H (hard)	12,000 – 24,000	59,500	10	44100128	FK SPK 0812/3 H	-
10	18	3	36	M (medium)	10,000 – 20,000	47,500	10	44171013	FK SPK 1018/3 M	-
				H (hard)	10,000 – 20,000	47,500	10	44100130	FK SPK 1018/3 H	-
12	18	3	36	M (medium)	8,000 – 16,000	39,500	10	44141218	FK SPK 1218/3 M	-
Shank diameter 6 mm										
10	18	6	41	M (medium)	10,000 – 20,000	47,500	10	44101691	FK SPK 1018/6 M	-
				H (hard)	10,000 – 20,000	47,500	10	44100132	FK SPK 1018/6 H	-
15	20	6	42	M (medium)	6,000 – 12,000	31,500	10	44171526	FK SPK 1520/6 M	-
	30	6	45	M (medium)	6,000 – 12,000	31,500	10	44171536	FK SPK 1530/6 M	-
20	25	6	47	M (medium)	5,000 – 10,000	23,500	10	44152025	FK SPK 2025/6 M	-
25	30	6	45	M (medium)	4,000 – 8,000	19,000	10	47901128	FK SPK 2530/6 M	-
30	35	6	42	M (medium)	3,200 – 6,350	15,500	10	47901129	FK SPK 3035/6 M	-

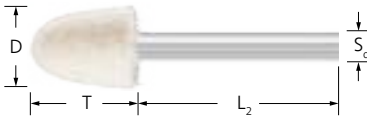

Shape KEL

The conical shape KEL is mainly used for pre-polishing and high-gloss polishing of radii.



Special features:

- Precise retention of geometric shapes due to the hardness of these tools.
- Can be profiled as desired, meaning they can also be used for tools with complex geometries.
- Use diamond polishing pastes and polishing paste bars. Please order separately.

D [mm]	T [mm]	S _d [mm]	L ₂ [mm]	Version	Opt. RPM	Max. RPM		Item no.	Designation	Price/unit EUR
Shank diameter of 2.35 mm										
6	10	2.35	37	M (medium)	16,000 – 32,000	79,500	10	44100180	FK KEL 0610/2,35 M	-
Shank diameter 3 mm										
6	10	3	37	M (medium)	16,000 – 32,000	79,500	10	47901130	FK KEL 0610/3 M	-
10	15	3	34	M (medium)	10,000 – 20,000	47,500	10	47901133	FK KEL 1015/3 M	-
Shank diameter 6 mm										
10	15	6	40	M (medium)	10,000 – 20,000	47,500	10	47901141	FK KEL 1015/6 M	-
15	20	6	42	M (medium)	6,000 – 12,000	31,500	10	44151521	FK KEL 1520/6 M	-
20	25	6	47	M (medium)	5,000 – 10,000	23,500	10	44182026	FK KEL 2025/6 M	-
				H (hard)	5,000 – 10,000	23,500	10	44100190	FK KEL 2025/6 H	-
	30	6	45	M (medium)	5,000 – 10,000	23,500	10	44100192	FK KEL 2030/6 M	-
				H (hard)	5,000 – 10,000	23,500	10	44100193	FK KEL 2030/6 H	-
25	30	6	45	M (medium)	4,000 – 8,000	19,000	10	44101711	FK KEL 2530/6 M	-
30	35	6	42	M (medium)	3,200 – 6,350	15,500	10	44101721	FK KEL 3035/6 M	-

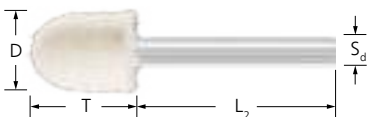

Shape WRC

The cylindrical shape with radius end WRC is mainly used for pre-polishing and high-gloss polishing of small, concave contours.

Special features:

- Precise retention of geometric shapes due to the hardness of these tools.
- Can be profiled as desired, meaning they can also be used for tools with complex geometries.
- Use diamond polishing pastes and polishing paste bars. Please order separately.

D [mm]	T [mm]	S _d [mm]	L ₂ [mm]	Version	Opt. RPM	Max. RPM		Item no.	Designation	Price/unit EUR
Shank diameter of 2.35 mm										
6	10	2.35	37	M (medium)	16,000 – 32,000	79,500	10	44100230	FK WRC 0610/2,35 M	-
8	12	2.35	36	M (medium)	12,000 – 24,000	59,500	10	44100232	FK WRC 0812/2,35 M	-
10	14	2.35	35	M (medium)	10,000 – 20,000	47,500	10	44100234	FK WRC 1014/2,35 M	-
Shank diameter 3 mm										
6	10	3	36	M (medium)	16,000 – 32,000	79,500	10	47901099	FK WRC 0610/3 M	-
8	12	3	43	M (medium)	12,000 – 24,000	59,500	10	44140813	FK WRC 0812/3 M	-
10	14	3	35	M (medium)	10,000 – 20,000	47,500	10	44141014	FK WRC 1014/3 M	-
Shank diameter 6 mm										
15	20	6	42	M (medium)	6,000 – 12,000	31,500	10	44131526	FK WRC 1520/6 M	-
20	25	6	47	M (medium)	5,000 – 10,000	23,500	10	44132026	FK WRC 2025/6 M	-
25	30	6	45	M (medium)	4,000 – 8,000	19,000	10	44132536	FK WRC 2530/6 M	-



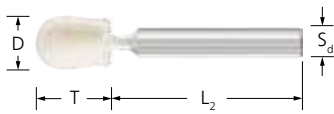

Shape TRE

The oval shape TRE is mainly used for pre-polishing and high-gloss polishing of small radii.

Special features:

- Precise retention of geometric shapes due to the hardness of these tools.
- Can be profiled as desired, meaning they can also be used for tools with complex geometries.
- Use diamond polishing pastes and polishing paste bars. Please order separately.

D [mm]	T [mm]	S _d [mm]	L ₂ [mm]	Version	Opt. RPM	Max. RPM		Item no.	Designation	Price/unit EUR
Shank diameter of 2.35 mm										
6	10	2.35	37	M (medium)	16,000 – 32,000	79,500	10	44100270	FK TRE 0610/2,35 M	-
8	12	2.35	36	M (medium)	12,000 – 24,000	59,500	10	44100274	FK TRE 0812/2,35 M	-
10	14	2.35	35	M (medium)	10,000 – 20,000	47,500	10	44100278	FK TRE 1014/2,35 M	-
Shank diameter 3 mm										
6	10	3	37	M (medium)	16,000 – 32,000	79,500	10	44100272	FK TRE 0610/3 M	-
8	12	3	36	M (medium)	12,000 – 24,000	59,500	10	44100276	FK TRE 0812/3 M	-
10	14	3	35	M (medium)	10,000 – 20,000	47,500	10	44100280	FK TRE 1014/3 M	-
Shank diameter 6 mm										
10	14	6	43	M (medium)	10,000 – 20,000	47,500	10	44101681	FK TRE 1014/6 M	-



Shape WKN

The tapered shape WKN is mainly used for pre-polishing and high-gloss polishing of interior angles.

Special features:

- Precise retention of geometric shapes due to the hardness of these tools.
- Can be profiled as desired, meaning they can also be used for tools with complex geometries.
- Use diamond polishing pastes and polishing paste bars. Please order separately.

D [mm]	T [mm]	S _d [mm]	L ₂ [mm]	Version	Opt. RPM	Max. RPM		Item no.	Designation	Price/unit EUR
Shank diameter of 2.35 mm										
10	15	2.35	32	M (medium)	10,000 – 20,000	47,500	10	44100324	FK WKN 1015/2,35 M	-
12	12	2.35	34	M (medium)	8,000 – 16,000	39,500	10	44100328	FK WKN 1212/2,35 M	-
				H (hard)	8,000 – 16,000	39,500	10	44100332	FK WKN 1212/2,35 H	-
Shank diameter 3 mm										
10	15	3	32	M (medium)	10,000 – 20,000	47,500	10	44100326	FK WKN 1015/3 M	-
12	12	3	36	M (medium)	8,000 – 16,000	39,500	10	44100330	FK WKN 1212/3 M	-
				H (hard)	8,000 – 16,000	39,500	10	44100334	FK WKN 1212/3 H	-
15	15	3	32	M (medium)	6,000 – 12,000	31,500	10	44100336	FK WKN 1515/3 M	-
				H (hard)	6,000 – 12,000	31,500	10	44100338	FK WKN 1515/3 H	-
20	16	3	28	M (medium)	5,000 – 10,000	23,500	10	44100340	FK WKN 2016/3 M	-
Shank diameter 6 mm										
20	16	6	38	M (medium)	5,000 – 10,000	23,500	10	44152016	FK WKN 2016/6 M	-

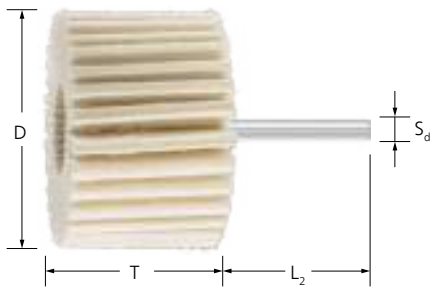

FLS

Mounted felt flap wheels are used for pre-polishing and high-gloss polishing on small to medium-sized components. Use the hard type for pre-polishing flat surfaces, and the soft type for high-gloss polishing and processing workpieces with lots of contours.



Special features:

- Highly flexible, enabling optimal adjustment to the contour. Low thermal load on the workpiece.
- If very fine finishes need to be achieved, the two types can be used successively.
- Use a polishing paste bar. Please order separately.

D [mm]	T [mm]	S _d [mm]	L ₂ [mm]	Version	Opt. RPM	Max. RPM		Item no.	Designation	Price/unit EUR
30	20	6	40	W (soft)	6,300	20,000	5	44383020	FLS 3020/6 W	-
				H (hard)	6,300	20,000	5	44383021	FLS 3020/6 H	-
40	20	6	40	W (soft)	4,750	15,000	5	44384020	FLS 4020/6 W	-
				H (hard)	4,750	15,000	5	44384021	FLS 4020/6 H	-
50	30	6	40	W (soft)	3,800	12,000	5	44385030	FLS 5030/6 W	-
				H (hard)	3,800	12,000	5	44385031	FLS 5030/6 H	-
60	40	6	40	W (soft)	3,150	10,000	5	44386040	FLS 6040/6 W	-
				H (hard)	3,150	10,000	5	44386041	FLS 6040/6 H	-
80	50	6	40	W (soft)	2,400	7,500	5	44388050	FLS 8050/6 W	-
				H (hard)	2,400	7,500	5	44388051	FLS 8050/6 H	-



Felt wheels and lenses FK SC/LI

FK SC/LI

Felt wheels and lenses are mainly used peripherally.

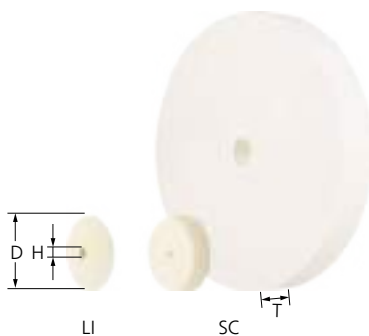

Special features:

- Precise retention of geometric shapes due to the hardness of these tools.
- Felt wheels with metal inserts (MS) are used for increased stock removal when pre-polishing with diamond grinding pastes.
- Use diamond polishing pastes and polishing paste bars. Please order polishing pastes and compatible arbor separately.

D [mm]	T [mm]	H [mm]	Version	Opt. RPM	Max. RPM	Suitable arbors		Item no.	Designation	Price/unit EUR
Lenses										
17	5	2	H (hard)	5,600 – 11,000	28,000	BO 2,3/1-6, BO 3/1,6	10	44367008	FK LI 1705/2 H	-
22	5	2	H (hard)	4,300 – 8,650	21,700	BO 2,3/1-6, BO 3/1,6	10	44367009	FK LI 2205/2 H	-
Discs										
17	5	2	M (medium)	5,600 – 11,000	28,000	BO 2,3/1-6, BO 3/1,6	10	44367005	FK SC 1705/2 M	-
20	5	2	M (medium)	5,000 – 10,000	23,500	BO 2,3/1-6, BO 3/1,6	10	44367006	FK SC 2005/2 M	-

Continued on next page

Polishing tools

Felt wheels and lenses FK SC/LI



D [mm]	T [mm]	H [mm]	Version	Opt. RPM	Max. RPM	Suitable arbors		Item no.	Designation	Price/unit EUR
30	5	2	M (medium)	3,000 – 6,000	20,000	BO 2,3/1-6, BO 3/1,6	10	44367007	FK SC 3005/2 M	-
	7	6	M (medium)	3,000 – 6,000	20,000	BO 6/6 3-10	5	44101742	FK SC 3007/6 M	-
45	9	6	M (medium)	2,000 – 4,000	13,500	BO 6/6 3-10	5	44101732	FK SC 4509/6 M	-
60	10	6	M (medium)	1,500 – 3,000	10,000	BO 6/6 3-10	5	44316010	FK SC 6010/6 M	-
80	10	10	M (medium)	1,000 – 2,000	7,500	BO 8/10	5	44367010	FK SC 8010/10 M	-
			MS (metal insert)	1,000 – 2,000	7,500	BO 8/10	5	44330801	FK SC 8010/10 MS	-
100	20	10	M (medium)	900 – 1,800	6,100	BO 8/10	1	44367110	FK SC 10020/10 M	-
			MS (metal insert)	900 – 1,800	6,100	BO 8/10	1	44331002	FK SC 10020/10 MS	-
125	20	20	M (medium)	750 – 1,500	4,900	BO 12/20, BO MK 1/20	1	44367220	FK SC 12520/20 M	-
			MS (metal insert)	750 – 1,500	4,900	BO 12/20, BO MK 1/20	1	44331252	FK SC 12520/20 MS	-
150	25	20	M (medium)	600 – 1,200	4,000	BO 12/20, BO MK 1/20	1	44367320	FK SC 15025/20 M	-
200	30	20	M (medium)	500 – 1,000	3,000	BO 12/20, BO MK 1/20	1	44367420	FK SC 20030/20 M	-

4



Felt flap discs FFS



FFS

Felt flap discs are used for pre-polishing and high-gloss polishing on medium-sized to large components. Use the hard type for pre-polishing flat surfaces, and the soft type for high-gloss polishing and processing workpieces with lots of contours.

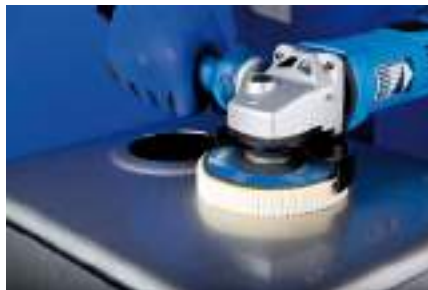

Special features:

- Highly flexible, enabling optimal adjustment to the contour. Low thermal load on the workpiece.
- If very fine finishes need to be achieved, the two types can be used successively.
- Use a polishing paste bar. Please order separately.

D [mm]	T [mm]	H [mm]	Version	Opt. RPM	Max. RPM		Item no.	Designation	Price/unit EUR
115	22	22.23	W (soft)	1,650	8,350	5	44370115	FFS 115/22,23 W	-
			H (hard)	1,650	8,350	5	44371115	FFS 115/22,23 H	-
125	22	22.23	W (soft)	1,500	7,650	5	44370125	FFS 125/22,23 W	-
			H (hard)	1,500	7,650	5	44371125	FFS 125/22,23 H	-

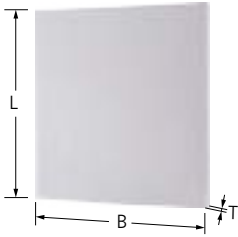

FK P

Felt sheets are suited to a very wide variety of manual polishing applications. The two different hardness grades available only multiply the number of potential applications.

Special features:

- Can be profiled as desired, meaning they can also be used for tools with complex geometries.
- Depending on the requirements, can be cut or punched into any shape (e.g. rectangle, square, stick or wheel) quickly and easily.

L [mm]	B [mm]	T [mm]	Version		Item no.	Designation	Price/unit EUR
250	250	3	M (medium)	1	44101100	FK P 250-250-3 M	-
		6	M (medium)	1	44101102	FK P 250-250-6 M	-
			H (hard)	1	44101104	FK P 250-250-6 H	-
		12	M (medium)	1	44101106	FK P 250-250-12 M	-
			H (hard)	1	44101108	FK P 250-250-12 H	-

Cloth rings

4

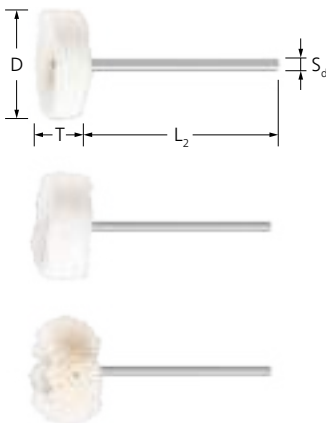

Shank-mounted cloth rings TR

For pre-polishing and high-gloss polishing with polishing pastes in tool and mould-making. Highly flexible, enabling optimal adjustment to the contour. Please order corresponding polishing pastes and arbor separately.



Special features:

- BW (cotton) type: very fine high-gloss polishing, dust removal and buffing.
- FZ (felt cloth) type: Pre-polishing and gloss polishing in combination with appropriate polishing pastes.
- FL (flannel) type: Buffing, gloss polishing and high-gloss polishing in combination with the appropriate polishing pastes.

D [mm]	T [mm]	S _d [mm]	L ₂ [mm]	Version	Opt. RPM	Max. RPM		Item no.	Designation	Price/unit EUR
Shank diameter 3 mm										
22	10	3	40	BW	13,000	17,350	10	44270227	TR 2210/3 BW	-
				FZ	13,000	17,350	10	44270228	TR 2210/3 FZ	-
				FL	13,000	17,350	10	44270229	TR 2210/3 FL	-



Cloth rings with hole TR

For pre-polishing and high-gloss polishing with polishing pastes. If the intention is to achieve very smooth surface finishes, use several or even all variants successively. Please order corresponding polishing pastes and arbor separately.

Special features:

- Highly flexible, enabling optimal adjustment to the contour.
- ST (sisal cloth) type: coarse pre-polishing;
- TH type (hard cloth): pre-polishing.
- TW (soft cloth) type: high-gloss polishing;
- FL (flannel) type: high-gloss polishing/buffing.

D [mm]	Usage width [mm]	H [mm]	Version	Opt. RPM	Max. RPM	Suitable arbors		Item no.	Designation	Price/unit EUR
50	10	6	TH	3,800	12,000	BO 6/6 3-10	5	44270503	TR 5010-6 TH	-
			TW	3,800	12,000	BO 6/6 3-10	5	44270504	TR 5010-6 TW	-
			FL	3,800	12,000	BO 6/6 3-10	5	44270505	TR 5010-6 FL	-
80	10	10	ST	2,500	7,500	BO 8/10	5	44270802	TR 8010-10 ST	-
			TH	2,500	7,500	BO 8/10	5	44270803	TR 8010-10 TH	-
			TW	2,500	7,500	BO 8/10	5	44270804	TR 8010-10 TW	-
			FL	2,500	7,500	BO 8/10	5	44270805	TR 8010-10 FL	-
100	10	10	ST	1,900	6,100	BO 8/10	5	44271003	TR 10010-10 ST	-
			TH	1,900	6,100	BO 8/10	5	44271004	TR 10010-10 TH	-
			TW	1,900	6,100	BO 8/10	5	44271005	TR 10010-10 TW	-
			FL	1,900	6,100	BO 8/10	5	44271006	TR 10010-10 FL	-
125	10	10	ST	1,300	4,900	BO 12/20, BO MK 1/20	5	44271253	TR 12510-10 ST	-
			TH	1,300	4,900	BO 12/20, BO MK 1/20	5	44271254	TR 12510-10 TH	-
		20	TW	1,300	4,900	BO 12/20, BO MK 1/20	5	44271255	TR 12510-20 TW	-
			FL	1,300	4,900	BO 12/20, BO MK 1/20	5	44271256	TR 12510-20 FL	-
150	10	20	ST	1,250	4,000	BO 12/20, BO MK 1/20	5	44271503	TR 15010-20 ST	-
			TH	1,250	4,000	BO 12/20, BO MK 1/20	5	44271504	TR 15010-20 TH	-
			TW	1,250	4,000	BO 12/20, BO MK 1/20	5	44271505	TR 15010-20 TW	-
			FL	1,250	4,000	BO 12/20, BO MK 1/20	5	44271506	TR 15010-20 FL	-
200	10	20	ST	950	3,000	BO 12/20, BO MK 1/20	5	44272003	TR 20010-20 ST	-
			TH	950	3,000	BO 12/20, BO MK 1/20	5	44272004	TR 20010-20 TH	-
			TW	950	3,000	BO 12/20, BO MK 1/20	5	44272005	TR 20010-20 TW	-
			FL	950	3,000	BO 12/20, BO MK 1/20	5	44272006	TR 20010-20 FL	-

Arbor

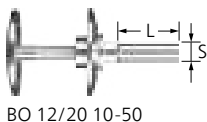
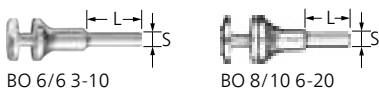

Arbor for felt wheels and cloth rings BO

Matching arbors for felt wheels and cloth rings.

Special features:

- High economic efficiency as tool can be changed quickly.

Suitable for hole diameter [mm]	S [mm]	L [mm]	Clamping range [mm]		Item no.	Designation	Price/unit EUR
6	6	25	3 – 10	1	42400006	BO 6/6 3-10	-
10	8	30	6 – 20	1	42400008	BO 8/10 6-20	-
20	12	35	10 – 50	1	42400012	BO 12/20 10-50	-
	-	-	10 – 50	1	42400062	BO MK 1/20 10-50	-



Grinding pastes SFP

Oil-soluble grinding pastes with sharp-edged silicon carbide grain (SiC) for very fine grinding work, e.g. grinding in valve seats, shaft bearings and as preparation for polishing with felt polishing tools and cloth rings.



Special features:

- High productivity.
- Quick results.
- Coordinated system.

Grit size	Contents [g]		Item no.	Designation	Price/unit EUR
90	250	1	44220090	SFP 90	-
150	250	1	44220150	SFP 150	-
280	250	1	44220280	SFP 280	-
360	250	1	44220360	SFP 360	-
600	250	1	44220600	SFP 600	-
800	250	1	44220800	SFP 800	-

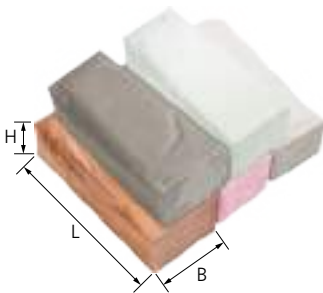

Polishing paste bar PP

Polishing pastes for felt tools and cloth rings for pre-polishing and high-gloss polishing. To achieve very smooth surface finishes, use pre-polishing paste (VP) and high-gloss polishing paste (HGP) one after the other. The polishing pastes have high productivity and lead to quick results.



Special features:

- PP 1, PP 2, PP 3: Use cloth rings in the ST (sisal cloth) version for coarse pre-polishing, and cloth rings in the TH (hard cloth) version for pre-polishing.
- PP 4, PP 5: Use cloth rings in the TW (soft cloth) version for high-gloss polishing, and cloth rings in the FL (flannel) version for high-gloss polishing/buffing.

Version	Use for	Contents [g]	Colour	B [mm]	H [mm]	L [mm]		Item no.	Designation	Price/unit EUR
Bulk pack										
Pre-polishing	Steel + INOX	1,100	green	70	50	140	1	44250001	G-PP 1 VP STEELOX	-
	Aluminium + brass	1,300	grey	70	50	140	1	44250002	G-PP 2 VP ALU	-
	Non-ferrous metals	1,150	brown	70	50	140	1	44250003	G-PP 3 VP NON-FERROUS	-
High-gloss polishing	All metals	1,150	pink	70	50	140	1	44250004	G-PP 4 HGP UNIVERSAL	-
	Plastics	1,100	beige	70	50	140	1	44250005	G-PP 5 HGP PLAST	-
Small pack										
Pre-polishing	Steel + INOX	108	green	25	30	90	1	44250006	K-PP 1 VP STEELOX	-
	Aluminium + brass	142	grey	25	30	90	1	44250007	K-PP 2 VP ALU	-
	Non-ferrous metals	111	brown	25	30	90	1	44250008	K-PP 3 VP NON-FERROUS	-
High-gloss polishing	All metals	132	pink	25	30	90	1	44250009	K-PP 4 HGP UNIVERSAL	-
	Plastics	104	beige	25	30	90	1	44250010	K-PP 5 HGP PLAST	-



Grinding oils and polishing pastes

Diamond polishing pastes



Diamond polishing pastes DPP, diamond polishing pastes type ECO DPP

Diamond polishing pastes guarantee quick and efficient work, particularly in tool-making and mould-making. For working on very hard materials, e.g. tungsten carbide and hardened steels. For use with felt polishing cones or wheels.

Special features:

- Can be thinned and dissolved with water and alcohol.
- High productivity. Quick results. Coordinated selections of grits.
- ECO diamond polishing pastes are an affordable alternative for less challenging applications.

Grit size [µm]	Contents [g]	Colour of sealing cap		Item no.	Designation	Price/unit EUR
DPP						
30 (coarse) = P 500	5	brown	1	44240030	DPP 30-5	-
	20	brown	1	44240130	DPP 30-20	-
15 (medium) = P 1200	5	blue	1	44240015	DPP 15-5	-
	20	blue	1	44240115	DPP 15-20	-
10 (medium-fine) = P 2000	5	light blue	1	44240010	DPP 10-5	-
	20	light blue	1	44240011	DPP 10-20	-
7 (fine) = P 3000	5	red	1	44240007	DPP 7-5	-
	20	red	1	44240107	DPP 7-20	-
3 (very fine) = P 5000	5	green	1	44240003	DPP 3-5	-
	20	green	1	44240103	DPP 3-20	-
1 (ultra-fine) = P 14000	5	yellow	1	44240001	DPP 1-5	-
	20	yellow	1	44240002	DPP 1-20	-
ECO DPP						
30 (coarse) = P 500	10	brown	1	44240202	DPP ECO 30-10	-
15 (medium) = P 1200	10	blue	1	44240192	DPP ECO 15-10	-
10 (medium-fine) = P 2000	10	light blue	1	44240182	DPP ECO 10-10	-
7 (fine) = P 3000	10	red	1	44240172	DPP ECO 7-10	-
3 (very fine) = P 5000	10	green	1	44240162	DPP ECO 3-10	-
1 (ultra-fine) = P 14000	10	yellow	1	44240152	DPP ECO 1-10	-



Special diluent for diamond polishing pastes PSP

The thinner is used to keep the lubricating layer between the support and the workpiece consistent during polishing work.

Special features:

- The diluent should be used extremely sparingly.
- Excessive use of the special diluent will wash out the diamond grit from the paste, thus diminishing polishing performance.

Contents [ml]		Item no.	Designation	Price/unit EUR
125	1	44250125	PSP 125	-



Grinding oils

Grinding oils are used in applications with coated abrasive tools. They increase the tool life and reduce heat build-up thanks to lubrication and cooling. Fewer chips adhere to the abrasive coating and a better surface is achieved.



Special features:

- Fe for steel: protects against corrosion.
- NE for non-ferrous metals and stainless steel (INOX): prevents the workpiece from becoming stained with unwanted marks, especially on stainless steel surfaces.
- ALU for aluminium: stops the grinding tool logging up.

Use for	Contents [ml]		Item no.	Designation	Price/unit EUR
Aerosol can					
Steel	400	1	42200001	410 Fe	-
Non-ferrous metals, INOX	400	1	42200002	411 NE	-
Aluminium	400	1	42200007	412 ALU	-
1 l canister					
Steel	1,000	1	42200003	410/1 Fe	-
Non-ferrous metals, INOX	1,000	1	42200005	411/1 NE	-
Aluminium	1,000	1	42200008	412/1 ALU	-
5 l canister					
Steel	5,000	1	42200004	410/5 Fe	-
Non-ferrous metals, INOX	5,000	1	42200006	411/5 NE	-
Aluminium	5,000	1	42200009	412/5 ALU	-



Cleaner



Universal cleaner UC-S

Highly effective, general workshop cleaner for cleaning and de-greasing components as a preparation for painting. Removes polishing paste residue, processing oils, corrosion-protection oils, light waxes and other types of contamination.



Special features:

- Biodegradable surfactants.
- Short drying time. Non-combustible.
- Versatile.

Contents [ml]		Item no.	Designation	Price/unit EUR
500	1	42200060	UC-S 500	-



INOX SHINER IS-S maintenance product

Maintenance product for protecting and caring for stainless steel (INOX), aluminium, non-ferrous metals, glass and plastic. Removes dust, fingerprints, oil and light scale deposits.



Special features:

- Leaves a dry, glossy protective film.
- Very easy to use. No cleaning marks.
- Versatile.

Contents [ml]		Item no.	Designation	Price/unit EUR
500	1	42200055	INOX SHINER IS-S 500	-

